

PRODUCT MONOGRAPH
INCLUDING PATIENT MEDICATION INFORMATION

Pr **ENBREL**[®]
etanercept

Solution in a Prefilled Syringe, 50 mg/mL
and
Lyophilized Powder in a Vial for Reconstitution, 25 mg/vial
Subcutaneous Injection

Pharmacopoeial Standard: Professed

Biological Response Modifier

IMMUNEX CORPORATION
Thousand Oaks, CA 91320, U.S.A.

Date of Initial Approval:
December 1, 2000

Distributed by:
AMGEN CANADA INC.
Mississauga, Canada L5N 0A4

Date of Revision:
March 19, 2021

Submission Control No: 245363

© 2003-2021 Amgen Canada Inc., All rights reserved

TABLE OF CONTENTS

PART I: HEALTH PROFESSIONAL INFORMATION	4
1 INDICATIONS	4
1.1 Pediatrics.....	4
1.2 Geriatrics.....	5
2 CONTRAINDICATIONS	5
3 SERIOUS WARNINGS AND PRECAUTIONS BOX	5
4 DOSAGE AND ADMINISTRATION	6
4.1 Dosing Considerations.....	6
4.2 Recommended Dose and Dosage Adjustment.....	6
4.4 Administration.....	7
4.5 Missed Dose.....	7
5 OVERDOSAGE	8
6 DOSAGE FORMS, STRENGTHS, COMPOSITION AND PACKAGING	8
7 WARNINGS AND PRECAUTIONS	9
7.1 Special Populations.....	16
7.1.1 Pregnant Women.....	16
7.1.2 Breast-feeding.....	17
7.1.3 Pediatrics.....	17
7.1.4 Geriatrics.....	17
8 ADVERSE REACTIONS	18
8.1 Adverse Reaction Overview.....	18
8.2 Clinical Trial Adverse Reactions.....	19
8.2.1 Clinical Trial Adverse Reactions - Pediatrics.....	27
8.3 Less Common Clinical Trial Adverse Reactions.....	27
8.5 Post-Market Adverse Reactions.....	28
9 DRUG INTERACTIONS	29
9.2 Drug Interactions Overview.....	29
9.4 Drug-Drug Interactions.....	29
10 CLINICAL PHARMACOLOGY	30
10.1 Mechanism of Action.....	30
10.2 Pharmacodynamics.....	30
10.3 Pharmacokinetics.....	31
11 STORAGE, STABILITY AND DISPOSAL	32
12 SPECIAL HANDLING INSTRUCTIONS	33
PART II: SCIENTIFIC INFORMATION	34
13 PHARMACEUTICAL INFORMATION	34
14 CLINICAL TRIALS	35
14.1 Adult Rheumatoid Arthritis (RA).....	35
14.2 Polyarticular Juvenile Idiopathic Arthritis (JIA).....	43

14.3	Adult Psoriatic Arthritis (PsA).....	44
14.4	Ankylosing Spondylitis (AS).....	47
14.5	Adult Plaque Psoriasis (PsO)	50
14.6	Pediatric Plaque Psoriasis (PsO).....	54
16	NON-CLINICAL TOXICOLOGY	56
	PATIENT MEDICATION INFORMATION	59
	Single-use Prefilled Syringe.....	59
	PATIENT MEDICATION INFORMATION	69
	Single-use Prefilled SureClick® Autoinjector	69
	PATIENT MEDICATION INFORMATION	86
	Multiple-use Vial	86

PART I: HEALTH PROFESSIONAL INFORMATION

1 INDICATIONS

ENBREL is indicated for:

- treatment of moderately to severely active rheumatoid arthritis (RA) in adults. Treatment is effective in reducing the signs and symptoms of RA, inducing major clinical response, inhibiting the progression of structural damage, and improving physical function. ENBREL can be initiated in combination with methotrexate (MTX) in adult patients or used alone.
- reducing signs and symptoms of moderately to severely active polyarticular juvenile idiopathic arthritis (JIA) in patients aged 4 to 17 years who have had an inadequate response to one or more disease-modifying antirheumatic drugs (DMARDs). Efficacy and safety have not been established in children less than 4 years of age.
- reducing signs and symptoms, inhibiting the progression of structural damage of active arthritis, and improving physical function in adult patients with psoriatic arthritis (PsA). ENBREL can be used in combination with methotrexate in adult patients who do not respond adequately to methotrexate alone.
- reducing signs and symptoms of active ankylosing spondylitis (AS).
- treatment of adult patients with chronic moderate to severe plaque psoriasis (PsO) who are candidates for systemic therapy or phototherapy.
- treatment of pediatric patients ages 4 to 17 years with chronic severe PsO who are candidates for systemic therapy or phototherapy. Data on safety and efficacy are limited in the age group 4 to 6 years.

Improvement may be seen as early as 1 week after initial administration of ENBREL in adults, and within 2 weeks in children with JIA and 4 weeks in PsO. Attainment of full effect was usually seen by 3 months in both populations and remained durable thereafter with continued treatment with ENBREL. Some patients see continuing improvement after 3 months of treatment with ENBREL.

After discontinuation of ENBREL, symptoms of arthritis generally returned within a month. Reintroduction of treatment with ENBREL in adults after discontinuation of up to 18 months resulted in the same magnitudes of response as patients who received ENBREL without interruption of therapy based on results of open-label studies. Reintroduction of ENBREL to children with JIA after discontinuation up to 4 months also resulted in a subsequent response to therapy.

1.1 Pediatrics

Efficacy and safety have not been established in children less than 4 years of age.

ENBREL is indicated in the treatment of polyarticular JIA in patients ages 4 to 17 who have had an inadequate response to one or more DMARDs, and in patients ages 4 to 17 with chronic PsO who are candidates for systemic therapy or phototherapy. Data on safety and efficacy in PsO patients are limited in the age group 4 to 6 years (see **WARNINGS AND PRECAUTIONS, Special Populations, Pediatrics**).

1.2 Geriatrics

Four hundred and eighty RA patients in clinical studies were age 65 or older. No overall differences in safety or effectiveness were observed between these patients and younger patients.

One hundred thirty-eight patients with PsO in clinical studies were age 65 or older. No overall differences in effectiveness were observed between younger and older patients with psoriasis. Because there is greater sensitivity and predisposition of older individuals to infection, caution should be used in treating the elderly (see **WARNINGS AND PRECAUTIONS, Special Populations, Geriatrics**).

2 CONTRAINDICATIONS

- ENBREL is contraindicated in patients who are hypersensitive to this drug or to any ingredient in the formulation, including any non-medicinal ingredient, or component of the container. For a complete listing, see **DOSAGE FORMS, STRENGTHS, COMPOSITION AND PACKAGING**.
- Patients with, or at risk of, sepsis syndrome, such as immunocompromised and HIV+ patients.

3 SERIOUS WARNINGS AND PRECAUTIONS BOX

Serious Warnings and Precautions

Infections

- **Serious infections leading to hospitalization or death, including sepsis, tuberculosis (TB), invasive fungal and other opportunistic infections, have been observed with the use of TNF-blocking agents including ENBREL. Cases of TB may be due to reactivation of latent TB infection or to new infection.**
- **Treatment with ENBREL should not be initiated in patients with active infections including TB, chronic or localized infections. Administration of ENBREL should be discontinued if a patient develops a serious infection or sepsis.**
- **Physicians also should exercise caution when considering the use of ENBREL in patients with a history of recurring or latent infections, including TB, or with underlying conditions, which may predispose patients to infections, such as advanced or poorly controlled diabetes.**
- **Before starting treatment with ENBREL, all patients should be evaluated for both active and inactive ('latent') TB. If inactive ('latent') TB is diagnosed, treatment for latent TB should be started with anti-TB therapy before the initiation of ENBREL.**
- **Patients should be monitored for the development of signs and symptoms of infection during and after treatment with ENBREL, including the possible development of tuberculosis in patients who tested negative for latent tuberculosis infection prior to initiating therapy (see **WARNINGS AND PRECAUTIONS, Serious and Opportunistic Infections**).**

Malignancies

- **Lymphoma and other malignancies, some fatal, have been reported in children and adolescent patients treated with TNF-blockers, including ENBREL (see further detail in Malignancies/Pediatric Patients section below).**

4 DOSAGE AND ADMINISTRATION

4.1 Dosing Considerations

ENBREL (etanercept) is intended for use under the guidance and supervision of a physician who has sufficient knowledge of RA, JIA, PsA, AS, or PsO and who has fully familiarized themselves with the efficacy/safety profile of ENBREL. Patients may self-inject only if their physician determines that it is appropriate and with medical follow-up, as necessary, after proper training in measurement of the correct dose and injection technique.

4.2 Recommended Dose and Dosage Adjustment

General

A 50 mg dose should be given as one subcutaneous (SC) injection. A 50 mg dose can also be given as two 25 mg SC injections.

When administering ENBREL as two 25 mg injections in adults or children, the injections should be given either on the same day once weekly or 3 or 4 days apart.

Adult Rheumatoid Arthritis, Psoriatic Arthritis, and Ankylosing Spondylitis Patients

The recommended dose of ENBREL for adult patients with RA, PsA, or AS is 50 mg per week. Methotrexate, glucocorticoids, salicylates, non-steroidal anti-inflammatory drugs (NSAIDs), or analgesics may be continued during treatment with ENBREL. Based on a study of 50 mg ENBREL twice weekly in patients with RA that suggested higher incidence of adverse reactions but similar American College of Rheumatology (ACR) response rates, doses higher than 50 mg per week are not recommended.

Adult Plaque Psoriasis Patients

The recommended starting dose of ENBREL for adult patients is a 50 mg dose given twice weekly (administered 3 or 4 days apart) for 3 months followed by a reduction to a maintenance dose of 50 mg per week. A maintenance dose of 50 mg given twice weekly has also been shown to be efficacious.

Pediatric Patients (Juvenile Idiopathic Arthritis or Plaque Psoriasis)

ENBREL should be administered by, or under the supervision of, a responsible adult.

The recommended dose of ENBREL for pediatric patients ages 4 to 17 years with active polyarticular JIA or PsO is 0.8 mg/kg per week (up to a maximum of 50 mg per week). The 50 mg prefilled syringe or SureClick[®] autoinjector may be used for pediatric patients weighing 63 kg (138 pounds) or more.

In JIA, glucocorticoids, NSAIDs, or analgesics may be continued during treatment with ENBREL.

Concurrent use with methotrexate and higher doses of ENBREL have not been studied in pediatric patients.

4.4 Administration

Preparation of ENBREL Using the Single-use Prefilled Syringe or Single-use Prefilled SureClick® Autoinjector:

Before injection, allow ENBREL to reach room temperature (approximately 15 to 30 minutes). DO NOT remove the needle cap while allowing the prefilled syringe or SureClick® autoinjector to reach room temperature.

Prior to administration, visually inspect the solution for particulate matter and discoloration. There may be small white particles of protein in the solution. This is not unusual for proteinaceous solutions. The solution should not be used if discoloured or cloudy, or if foreign particulate matter is present.

Preparation of ENBREL Using the Multiple-use Vial:

ENBREL should be reconstituted aseptically with 1 mL of the supplied Sterile Bacteriostatic Water for Injection (BWFI), USP (0.9% benzyl alcohol), giving a solution of 1.0 mL containing 25 mg of ENBREL.

A vial adapter is supplied for use when reconstituting the lyophilized powder. However, the vial adapter should not be used if multiple doses are going to be withdrawn from the vial. If the vial will be used for multiple doses, a 25-gauge needle should be used for mixing and withdrawing ENBREL and a 27-gauge needle should be used for injecting ENBREL, as the vial adapter is not recommended for multi-use. The needles and syringe should be used only once. The reconstituted solution is clear and colourless and must be used within 14 days.

During reconstitution of ENBREL, if not using the vial adapter, the diluent should be injected very slowly into the vial. Some foaming will occur. This is normal. To avoid excessive foaming, do not shake or vigorously agitate. The contents should be swirled gently during dissolution. Generally, dissolution of ENBREL takes less than 10 minutes. Reconstitution with the supplied BWFI yields a multiple-use preservative solution that expires 14 days after reconstitution. For pediatric patients to be treated with less than a 25 mg dose, write the date in the area marked "Mixing Date:" on the supplied sticker and attach the sticker to the vial immediately after reconstitution. Contents of one vial of ENBREL solution should not be mixed with, or transferred into, the contents of another vial of ENBREL.

Visually inspect the solution for particulate matter and discoloration prior to administration. The solution should not be used if discoloured or cloudy, or if particulate matter remains. Withdraw the solution into the syringe, removing only the dose to be given from the vial. Before injection, allow the ENBREL syringe to reach room temperature (approximately 15 to 30 minutes). Some foam or bubbles may remain in the vial.

Sites for injection include the thigh, abdomen, or upper arm. Injection sites should be rotated. New injections should be given at least one inch from an old site and never into areas where the skin is tender, bruised, red, or hard.

No other medications should be added to solutions containing ENBREL, and ENBREL should not be reconstituted with other diluents. Do not filter reconstituted solution during preparation or administration.

4.5 Missed Dose

Patients who miss a dose of ENBREL should be advised to inject their dose as soon as they remember, then take the next dose at the regular(ly) scheduled time.

5 OVERDOSAGE

The maximum tolerated dose of ENBREL has not been established in humans. Toxicology studies have been performed in monkeys at doses up to 30 times the human dose with no evidence of dose-limiting toxicities. No dose-limiting toxicities have been observed during clinical trials of ENBREL. Single IV doses up to 60 mg/m² have been administered to 32 healthy volunteers (25 males, 7 females) in an endotoxemia study without evidence of dose-limiting toxicities. The highest dose level evaluated in RA patients has been a single IV loading dose of 32 mg/m² followed by SC doses of 16 mg/m² (~ 25 mg) administered twice weekly. In one RA trial, one patient mistakenly self-administered 62 mg ENBREL SC twice weekly for 3 weeks without experiencing adverse effects.

For management of a suspected drug overdose, contact your regional poison control centre.

6 DOSAGE FORMS, STRENGTHS, COMPOSITION AND PACKAGING

To help ensure the traceability of biologic products, including biosimilars, health professionals should recognize the importance of recording both the brand name and the non-proprietary (active ingredient) name as well as other product-specific identifiers such as the Drug Identification Number (DIN) and the batch/lot number of the product supplied.

Dosage Forms, Strengths, Composition and Packaging

Route of Administration	Dosage Form / Strength/ Composition	Non-medicinal Ingredients
Subcutaneous injection (SC)	Sterile solution for injection / 50 mg/mL prefilled syringe (0.51 mL [†] and 0.98 mL per syringe) and 50 mg/mL autoinjector (0.98 mL) Lyophilized powder for reconstitution / 25 mg/vial	Solution for injection: L-arginine hydrochloride, sodium chloride, sucrose, and Water for Injection, USP. Lyophilized powder: mannitol, sucrose, and tromethamine.

† 0.51 mL prefilled syringe is not available in Canada.

ENBREL single-use prefilled syringes are available in 25 mg* (0.51 mL of a 50 mg/mL solution of etanercept, minimum deliverable volume of 0.47 mL) and 50 mg (0.98 mL of a 50 mg/mL solution of etanercept, minimum deliverable volume of 0.94 mL) dosage strength.

ENBREL SureClick[®] autoinjectors are available in 50 mg (0.98 mL of a 50 mg/mL solution of etanercept, minimum deliverable volume of 0.94 mL) dosage strength. Prefilled syringes and autoinjectors are intended for subcutaneous injection.

The solution of ENBREL is clear and colourless, sterile, preservative free, and is formulated at pH 6.3 ± 0.2. There may be small white particles of protein in the solution. Each ENBREL single-use prefilled syringe and SureClick[®] autoinjector contains:

50 mg/mL solution of etanercept with 1% sucrose, 120 mM sodium chloride, 25 mM L-arginine hydrochloride, and Water for Injection, USP.

*25 mg single-use prefilled syringe is not available in Canada.

ENBREL 25 mg* and 50 mg single-use prefilled syringes and ENBREL 50 mg single-use prefilled SureClick® autoinjectors are supplied in cartons containing four syringes or autoinjectors with 27-gauge, ½ inch needles. A single syringe or autoinjector replacement carton is available if needed.

Administration of one 50 mg ENBREL prefilled syringe or one ENBREL SureClick® autoinjector provides a dose equivalent to two 25 mg* ENBREL prefilled syringes or two multi-use vials of lyophilized ENBREL when vials are reconstituted and administered as recommended.

ENBREL multiple-use vial contains sterile, white, preservative-free lyophilized powder. Reconstitution with 1 mL of the supplied Sterile Bacteriostatic Water for Injection (BWFI), USP (containing 0.9% benzyl alcohol) yields a multiple-use, clear, and colourless solution with a pH of 7.4 ± 0.3 containing 25 mg etanercept, 40 mg mannitol, 10 mg sucrose, and 1.2 mg tromethamine.

ENBREL multiple-use vial is supplied in a carton containing four dose trays. Each dose tray contains one 25 mg vial of etanercept, one diluent syringe (1 mL Sterile Bacteriostatic Water for Injection, USP, containing 0.9% benzyl alcohol), one 27-gauge ½ inch needle, one vial adapter, and one plunger. Each carton contains four "Mixing Date:" stickers. A single dose replacement tray is available, if needed.

7 WARNINGS AND PRECAUTIONS

Please see the **SERIOUS WARNINGS AND PRECAUTIONS BOX** at the beginning of **PART I: HEALTH PROFESSIONAL INFORMATION**.

Serious and Opportunistic Infections

Serious and sometimes fatal infections due to bacterial, mycobacterial, invasive fungal, viral, parasitic (including protozoal), or other opportunistic pathogens have been reported in patients receiving TNF-blocking agents. Tuberculosis, histoplasmosis, aspergillosis, blastomycosis, candidiasis, coccidioidomycosis, legionellosis, listeriosis, and pneumocystosis have been reported (see ADVERSE REACTIONS, Infections). Patients have frequently presented with disseminated rather than localized disease. Many of the serious infections have occurred in patients on concomitant immunosuppressive therapy that, in addition to their underlying disease, could predispose them to infections.

Treatment with ENBREL should not be initiated in patients with an active infection, including clinically important localized infections. The risks and benefits of treatment should be considered prior to initiating therapy in patients:

*25 mg single-use prefilled syringe is not available in Canada.

- With chronic or recurrent infection;
- Who have been exposed to tuberculosis;
- With a history of an opportunistic infection;
- Who have resided or traveled in areas of endemic tuberculosis or mycoses, such as histoplasmosis, coccidioidomycosis, or blastomycosis;
- With underlying conditions that may predispose them to infection such as advanced or poorly controlled diabetes.

Cases of reactivation of tuberculosis or new tuberculosis infections have been observed in patients receiving ENBREL, including patients who have previously received treatment for latent or active tuberculosis. Patients should be evaluated according to the Canadian Tuberculosis Standards guidelines for tuberculosis risk factors and tested for latent infection prior to initiating ENBREL and during therapy as appropriate. Prescribers are reminded of the risk of false negative tuberculin skin test results, especially in patients who are severely ill or immuno-compromised.

If active tuberculosis is diagnosed, ENBREL therapy should not be initiated. If inactive ('latent') tuberculosis is diagnosed, treatment should be started with anti-tuberculosis therapy before the initiation of ENBREL. In this situation, the benefit/risk balance of ENBREL therapy should be very carefully considered. Anti-tuberculosis therapy should also be considered prior to initiation of ENBREL in patients with a past history of latent or active tuberculosis in whom an adequate course of treatment cannot be confirmed, and for patients with a negative test for latent tuberculosis but having risk factors for tuberculosis infection. Consultation with a physician with expertise in the treatment of tuberculosis is recommended to aid in the decision whether initiating anti-tuberculosis therapy is appropriate for an individual patient.

Patients should be monitored for the development of signs and symptoms of infection during and after treatment with ENBREL, including the possible development of tuberculosis in patients who tested negative for latent tuberculosis infection prior to initiating therapy. Tests for latent tuberculosis infection may be falsely negative while on therapy with ENBREL.

Tuberculosis should be strongly considered in patients who develop a new infection during ENBREL treatment, especially in patients who have previously or recently traveled to countries with a high prevalence of tuberculosis, or who have had close contact with a person with active tuberculosis.

Histoplasmosis and other invasive fungal infections are not consistently recognized in patients taking TNF-blockers, including ENBREL. This has resulted in delays in appropriate treatment, sometimes resulting in death. For patients who reside or travel in regions where mycoses are endemic, invasive fungal infection should be suspected if they develop a serious systemic illness. Appropriate empiric antifungal therapy may be initiated while a diagnostic workup is being performed. Antigen and antibody testing for histoplasmosis may be negative in some patients with active infection. When feasible, the decision to administer empiric antifungal therapy in these patients should be made in consultation with a physician with expertise in the diagnosis and treatment of invasive fungal infections and taking into account both the risk for severe fungal infection and the risks of antifungal therapy.

ENBREL should be discontinued if a patient develops a serious infection or sepsis. A patient who develops a new infection during treatment with ENBREL should be closely

monitored, undergo a prompt and complete diagnostic workup appropriate for an immunocompromised patient, and antimicrobial therapy should be initiated, as appropriate.

In post-marketing studies of patients with JIA, serious infections have been reported in approximately 3% of patients. Sepsis has also been reported in the post-market setting (0.8%).

General

Parenteral administration of any biologic product should be attended by appropriate precautions in case an allergic or untoward reaction occurs. Allergic reactions associated with administration of ENBREL during clinical trials have been reported in < 2% of patients. If any serious allergic or anaphylactic reaction occurs, administration of ENBREL should be discontinued immediately and appropriate therapy initiated.

Caution: The following components contain dry natural rubber (a derivative of latex), which may cause allergic reactions in individuals sensitive to latex: the needle cover of the prefilled syringe and the needle cover within the needle cap of the SureClick® autoinjector.

Concurrent ENBREL and anakinra treatment

Serious infections and neutropenia were seen in clinical studies with concurrent use of anakinra and ENBREL with no added clinical benefit compared to ENBREL alone. Because of the nature of the adverse events seen with combination of ENBREL and anakinra therapy, the combination of ENBREL and anakinra is not recommended (see **DRUG INTERACTIONS**).

Concurrent ENBREL and abatacept treatment

In clinical studies, concurrent administration of abatacept and ENBREL resulted in increased incidences of serious adverse events and did not demonstrate increased clinical benefit. Use of ENBREL with abatacept is not recommended (see **DRUG INTERACTIONS**).

Switching between Biological DMARDS

When switching from one biologic to another, patients should continue to be monitored for signs of infection.

Surgery

There is limited safety experience of surgical procedures in patients treated with ENBREL. The half-life of ENBREL should be taken into consideration if a surgical procedure is planned. A patient who requires surgery while on ENBREL should be closely monitored for infections, and appropriate actions should be taken.

Granulomatosis with Polyangiitis

In a randomized placebo controlled study of 180 patients with granulomatosis with polyangiitis, the addition of ENBREL to standard treatment (including cyclophosphamide, methotrexate, and corticosteroids) was no more efficacious than standard therapy alone. Patients receiving ENBREL experienced more non-cutaneous malignancies than patients receiving placebo. The role of ENBREL in this finding is uncertain due to imbalances between the two arms of the study including age, disease duration, and use of cyclophosphamide. The use of ENBREL in patients with granulomatosis with polyangiitis receiving immunosuppressive agents is not recommended. The use of ENBREL in any patients receiving concurrent cyclophosphamide therapy is not recommended.

Carcinogenesis and Mutagenesis

Long-term animal studies have not been conducted to evaluate the carcinogenic potential of ENBREL or its effect on fertility. Mutagenesis studies were conducted *in vitro* and *in vivo*, and no evidence of mutagenic activity was observed.

Cardiovascular

Two large clinical trials (2048 patients) evaluating the use of ENBREL in the treatment of heart failure were terminated early due to lack of efficacy. There was a suggestion of worse heart failure outcomes in patients with moderate to severe congestive heart failure (CHF [NYHA Class III/IV]) receiving ENBREL treatment compared to patients receiving placebo in one of the two trials.

There have been post-marketing reports of worsening of CHF, with and without identifiable precipitating factors, in patients taking ENBREL. Physicians should exercise caution when using ENBREL in patients who also have CHF, particularly NYHA Class III/IV.

Endocrine and Metabolism

There have been reports of hypoglycemia following initiation of ENBREL in patients receiving medication for diabetes, necessitating a reduction in anti-diabetic medication in some of these patients.

Gastrointestinal

There have been reports of Inflammatory Bowel Disease (IBD) in JIA patients receiving ENBREL, which is not effective for the treatment of IBD.

During the controlled portions of ENBREL trials, across all indications in pediatric and adult patients, the estimated incidence proportion of IBD events in participants on etanercept was 0.37%, a 2-fold increase over the incidence proportion of 0.19% in the placebo or control group,

Hematologic

Rare cases (less than 1 case out of 1000 patients treated) of neutropenia, leukopenia, thrombocytopenia, anemia and pancytopenia (including aplastic anemia), some with fatal outcomes, have been reported in patients treated with ENBREL. Cases of pancytopenia occurred as early as two weeks after initiating ENBREL therapy. The causal relationship to ENBREL therapy remains unclear. While the majority of patients who developed pancytopenia had recent or concurrent exposure to other anti-rheumatic medications known to be associated with myelosuppression (eg, methotrexate, leflunomide, azathioprine, and cyclophosphamide), some patients had no recent or concurrent exposure to such therapies. Although no high risk group has been identified, caution should be exercised in patients being treated with ENBREL who have a previous history of significant hematologic abnormalities. All patients should be advised to seek immediate medical attention if they develop signs and symptoms suggestive of blood dyscrasias or infection (eg, persistent fever, bruising, bleeding, pallor) while on ENBREL. Discontinuation of ENBREL therapy should be considered in patients with confirmed significant hematologic abnormalities.

Patients treated with anakinra plus etanercept (3/139, 2%) developed neutropenia (ANC < 1 x 10⁹/L). While neutropenic, one of these patients developed cellulitis that resolved with antibiotic therapy.

Hepatic/Biliary/Pancreatic

Hepatitis B Reactivation

Reactivation of hepatitis B in patients who were previously infected with the hepatitis B virus (HBV) and had received concomitant TNF-blocking agents, including very rare cases with ENBREL, has been reported. In the majority of cases, patients were also being treated with other immunosuppressive drugs, including methotrexate, azathioprine, and/or corticosteroids. Hepatitis B reactivation is not unique to TNF-blockers and has been reported with other immunosuppressive drugs. Therefore, a direct causal relationship to TNF-blockers has not been established. Patients should be evaluated for prior evidence of HBV infection before initiating TNF-blocker therapy. Those previously infected with HBV should be monitored for signs and symptoms of active HBV infection throughout the course of therapy and for several months following discontinuation of therapy.

Use in Patients with Moderate to Severe Alcoholic Hepatitis

Physicians should use caution when using ENBREL in patients with moderate to severe alcoholic hepatitis. In a study of 48 hospitalized patients treated with ENBREL or placebo for moderate to severe alcoholic hepatitis, the mortality rate in patients treated with ENBREL was similar to patients treated with placebo at one month but significantly higher after six months. Therefore, the use of ENBREL for the treatment of patients with alcoholic hepatitis is not recommended.

Immune

Immunosuppression and Immunocompetence

The possibility exists for TNF-blocking agents, including ENBREL, to affect host defenses against infections and malignancies since TNF mediates inflammation and modulates cellular immune responses. In a study of 49 patients with RA treated with ENBREL, there was no evidence of depression of delayed-type hypersensitivity, depression of immunoglobulin levels, or change in enumeration of effector cell populations. The role of ENBREL in the development and course of malignancies as well as active and/or chronic infections is not fully understood. The safety and efficacy of ENBREL in patients with immunosuppression or chronic infections have not been evaluated.

Immunizations

Live vaccines (including yellow fever, Bacille Calmette-Guerin [BCG], rubella, polio, cholera, typhoid and varicella) should not be given concurrently with ENBREL. Patients receiving ENBREL may receive concurrent vaccinations, except for live vaccines. No data are available on the secondary transmission of infection by live vaccines in patients receiving ENBREL.

No data are available on the effects of vaccination in RA patients receiving ENBREL. Most PsA patients receiving ENBREL were able to mount effective B-cell immune response to pneumococcal polysaccharide vaccine, but titers in aggregate were moderately lower and fewer patients had two-fold rises in titers compared to patients not receiving ENBREL. The clinical significance of this is unknown. In a study of 205 adult patients with PsA, antibody response to polysaccharide pneumococcal vaccine was similar in patients receiving placebo or ENBREL for the following antigens: 9V, 14, 18C, 19F and 23F.

It is recommended that pediatric patients, if possible, be brought up to date with all immunizations in agreement with current immunization guidelines prior to initiating ENBREL therapy. Two JIA patients developed varicella infection and signs and symptoms of aseptic meningitis, which resolved without sequelae. Patients with a significant exposure to varicella virus should temporarily discontinue ENBREL therapy and be considered for prophylactic treatment with Varicella Zoster Immune Globulin.

Autoimmunity

Treatment with ENBREL may result in the formation of autoantibodies and, rarely, can result in the development of lupus-like syndrome or autoimmune hepatitis, which may resolve following withdrawal of ENBREL. If a patient develops symptoms and findings suggestive of a lupus-like syndrome or autoimmune hepatitis following treatment with ENBREL, treatment should be discontinued and the patient should be carefully evaluated.

Malignancies

Lymphomas

In the controlled portions of clinical trials of all the TNF-blocking agents, more cases of lymphoma have been observed among patients receiving the TNF-blocker compared to control patients. In the controlled and open-label portions of clinical trials of ENBREL in RA, AS, and PsA patients, the observed rate of lymphoma was 0.10 cases per 100 patient-years. This is 3-fold higher than expected in the general population. Patients with RA or PsO, particularly those with highly active disease and/or chronic exposure to immunosuppressant therapies, may be at a higher risk (up to several fold) for the development of lymphoma.

Post-marketing cases of hepatosplenic T-cell lymphoma (HSTCL), a rare type of T-cell lymphoma that has a very aggressive disease course and is usually fatal, have been reported in patients treated with TNF-blockers. The majority of reported TNF-blocker cases occurred in adolescent and young adult males with Crohn's disease or ulcerative colitis. Almost all of these patients had received treatment with the immunosuppressants azathioprine and/or 6-mercaptopurine concomitantly with a TNF-blocker at or prior to diagnosis.

Leukemia

Cases of acute and chronic leukemia have been reported in association with post-marketing TNF-blocker use in RA and other indications. Even in the absence of TNF-blocker therapy, patients with RA may be at higher risk (approximately 2-fold) than the general population for the development of leukemia.

During the controlled portions of ENBREL trials, 2 cases of leukemia were observed among 5445 (0.06 cases per 100 patient-years) ENBREL-treated patients versus 0 among 2890 (0%) control patients (duration of controlled treatment ranged from 3 to 48 months).

Among 15,401 patients treated with ENBREL in controlled and open portions of clinical trials representing approximately 23,325 patient-years of therapy, the observed rate of leukemia was 0.03 cases per 100 patient-years (see **ADVERSE REACTIONS, Clinical Trial Adverse Reactions, Malignancies**).

Other Malignancies

For malignancies other than lymphoma and non-melanoma skin cancer, there was no difference in exposure-adjusted rates between the ENBREL and control arms in the controlled portions of clinical studies for all indications. Analysis of the malignancy rate in combined controlled and uncontrolled portions of studies has demonstrated that types and rates are similar to what is expected in the general population based on the Surveillance, Epidemiology and End Results (SEER) database and suggest no increase in rates over time.

Whether treatment with ENBREL might influence the development and course of malignancies in adults is unknown (see **ADVERSE REACTIONS, Clinical Trial Adverse Reactions, Malignancies**).

Melanoma and Non-melanoma skin cancer (NMSC)

Melanoma and non-melanoma skin cancer (NMSC) have been reported in patients treated with TNF-blocking agents, including ENBREL. In controlled and open portions of clinical trials among 15,401 patients treated with ENBREL representing approximately 23,325 patient-years of therapy, the observed rate of melanoma was 0.043 cases per 100 patient-years. In controlled clinical trials of rheumatology (RA, AS, PsA) patients, the observed rate of NMSC was 0.41 cases per 100 patient-years in the ENBREL-treated patients compared to 0.37 cases per 100 patient-years among control patients. In controlled clinical trials of adult PsO patients, the observed rate of NMSC was 3.54 cases per 100 patient-years in the ENBREL-treated patients compared to 1.28 cases per 100 patient-years among control patients (see **ADVERSE REACTIONS, Clinical Trial Adverse Drug Reactions, Malignancies**). Post-marketing cases of Merkel cell carcinoma have been reported very infrequently in patients treated with ENBREL.

Risk factors for melanoma or NMSC include cumulative exposure to ultraviolet light, increasing age, male gender, fair complexion, history of acute sunburn or skin cancer, tobacco use, and immunosuppressive agents. Periodic skin examination should be considered for all patients at increased risk for skin cancers.

Pediatric Patients

Malignancies, some fatal, have been reported among children, adolescents and young adults (≤ 22 years of age) who initiated treatment with TNF-blocking agents (initiation of therapy at ≤ 18 years of age), including ENBREL. These cases were reported post-marketing and are derived from a variety of sources including registries and spontaneous post-marketing reports. Approximately half the cases were lymphomas, including Hodgkin's and non-Hodgkin's lymphoma. Of these cases, hepatosplenic T-cell lymphoma was not reported in patients treated with ENBREL. The other cases represented a variety of different malignancies and included rare malignancies usually associated with immunosuppression and malignancies that are not usually observed in children and adolescents. Approximately half of these malignancies occurred in patients being treated for inflammatory bowel disease; approximately one-third of the cases occurred in patients being treated for JIA. The malignancies occurred after a median of 30 months of therapy (range 1 to 84 months). Most of the patients were receiving concomitant immunosuppressants.

In clinical trials of 1154 patients treated with ENBREL (representing 2039 patient-years of therapy) no malignancies, including lymphoma or NMSC, have been reported.

Neurologic

Treatment with TNF-blocking agents, including ENBREL, has been associated with rare cases of new onset or exacerbation of central nervous system disorders, including demyelinating disorders, some presenting with mental status changes and some associated with permanent disability, and with peripheral nervous system demyelinating disorders. Rare cases of transverse myelitis, optic neuritis, and new onset or exacerbation of seizure disorders have been observed in association with ENBREL therapy. Guillain-Barré like syndromes have been reported very rarely in post-marketing experience with ENBREL therapy. While no clinical trials have been performed evaluating ENBREL therapy in patients with multiple sclerosis, other TNF-blocking agents administered to patients with multiple sclerosis have been associated with increases in disease activity. Prescribers should exercise caution in considering the use of ENBREL in patients with pre-existing or recent-onset central or peripheral nervous system demyelinating disorders. Development of new, confirmed central nervous system demyelination in patients on ENBREL warrants consideration of discontinuation of the medication.

7.1 Special Populations

7.1.1 Pregnant Women

ENBREL crosses the placenta and has been detected in the serum of infants born to women treated with ENBREL during pregnancy. The clinical impact of this exposure is unknown; however, infants may be at increased risk of infection. Administration of live vaccines to infants for 16 weeks after the mother's last dose of ENBREL is generally not recommended.

Human Data

Available data from observational studies with use of etanercept during pregnancy do not reliably support an association between etanercept and major birth defects.

A prospective cohort pregnancy registry conducted by the Organization of Teratology Information Specialists (OTIS) in the United States (US) and Canada between 2000 and 2012 compared the risk of major birth defects in liveborn infants of women with rheumatic diseases or psoriasis exposed to etanercept in the first trimester. The proportion of major birth defects among liveborn infants in the etanercept-exposed (N=319) and diseased etanercept-unexposed cohorts (N=144) was 9.4% and 3.5%, respectively. No pattern of major or minor birth defects were seen.

A Scandinavian study compared the risk of major birth defects in liveborn infants of women with chronic inflammatory disease (CID) exposed to TNF-blockers during early pregnancy. Women were identified from the Danish (2004-2012) and Swedish (2006-2012) population-based health registers. The proportion of major birth defects among liveborn infants in the etanercept-exposed (N=344) and CID etanercept-unexposed cohorts (N=21,549) was 7.0% and 4.7%, respectively.

Overall, while both the OTIS Registry and Scandinavian study show a higher proportion of birth defects in etanercept-exposed patients compared to diseased etanercept-unexposed patients, these results should be interpreted with caution given the limitations with both studies and no pattern of birth defects were observed.

Animal Data

In embryofetal development studies with etanercept administered during the period of organogenesis to pregnant rats from gestation day (GD) 6 through 20 or pregnant rabbits from GD 6 through 18, there was no evidence of fetal malformations or embryotoxicity in rats or rabbits at respective doses that achieved systemic exposures 48 to 58 times the exposure in

patients treated with 50 mg ENBREL once weekly (on an AUC basis with maternal subcutaneous doses up to 30 mg/kg/day in rats and 40 mg/kg/day in rabbits). In a peri- and post-natal development study with pregnant rats that received etanercept during organogenesis and the later gestational period from GD 6 through 21, development of pups through postnatal day 4 was unaffected at doses that achieved exposures 48 times the exposure in patients treated with 50 mg ENBREL once weekly (on an AUC basis with maternal subcutaneous doses up to 30 mg/kg/day).

7.1.2 Breast-feeding

Limited data from published literature show that etanercept is present in low levels in human milk and minimally absorbed by a breastfed infant. No data are available on the effects of etanercept on the breastfed child or the effects on milk production. The developmental and health benefits of breastfeeding should be considered along with the mother's clinical need for ENBREL and any potential adverse effects on the breastfed child from the drug or from the underlying maternal condition.

7.1.3 Pediatrics

ENBREL is indicated for treatment of polyarticular JIA in patients aged 4 to 17 who have had an inadequate response to one or more DMARDs, and for treatment of chronic severe PsO in patients ages 4 to 17 who are candidates for systemic therapy or phototherapy. Data on safety and efficacy in PsO patients are limited in the age group 4 to 6 years.

In post-marketing studies with JIA, serious infections have been reported in approximately 3% of patients. Sepsis has also been reported in the post-market setting (0.8%). The long-term effects of ENBREL therapy on skeletal, behavioural, cognitive, sexual and immune maturation and development in children are unknown.

A higher rate of adverse events was noted when JIA patients in an observational registry received ENBREL therapy in combination with methotrexate. As the JIA patients receiving combination therapy had more severe disease, since they had failed prior therapeutic trials with either ENBREL or methotrexate alone, it remains unclear whether the higher event rate is related to therapy or underlying disease severity.

ENBREL has been studied in 69 children with moderately to severely active polyarticular JIA aged 2 to 17 years.

ENBREL has not been studied in children < 2 years of age.

ENBREL has been studied in 211 pediatric patients with moderate to severe PsO aged 4 to 17 in a 48-week placebo controlled study followed by an open-label extension study in 182 of these patients for up to 264 additional weeks. Data on safety and efficacy are limited in the age group 4 to 6 years. Only 12 patients in this age range have been studied.

7.1.4 Geriatrics

Four hundred and eighty clinical study patients in RA were age 65 or older. No overall differences in safety or effectiveness were observed between these patients and younger patients.

One hundred and thirty-eight PsO patients in clinical studies were age 65 or older. No overall differences in effectiveness were observed between younger and older psoriasis patients. In controlled trials of PsO, rates of serious adverse events were seen at a frequency of < 1.5% among ENBREL- and placebo-treated patients in the first 3 months of treatment. However, in patients greater than 65 years of age treated with ENBREL 50 mg twice weekly, serious

adverse events occurred at a higher rate than in younger patients. In long-term open-label trials of PsO serious non-infectious adverse events were infrequent and exposure-adjusted event rates generally remained stable throughout ENBREL treatment. Although data for patients aged 65 or greater in the long-term trials are limited, adverse events, including serious adverse events, occurred at a higher frequency for patients treated with 50 mg twice weekly (see **ADVERSE REACTIONS, Adverse Reaction Overview**).

Greater sensitivity of some older individuals cannot be ruled out. Predisposition of older individuals to infection justifies greater caution when treating the elderly.

8 ADVERSE REACTIONS

8.1 Adverse Reaction Overview

Adverse Reactions in Adult Patients with Rheumatoid Arthritis, Psoriatic Arthritis, Ankylosing Spondylitis or Plaque Psoriasis

ENBREL has been studied in 1442 patients with RA who have been followed for over 6 years, including 225 patients who have been followed for more than 10 years. ENBREL has been studied in 169 adult patients with PsA for up to 24 months, in 222 patients with AS for up to 48 months and in 1864 adult patients with PsO for up to 36 months. ENBREL has over four million patient-years of post-market exposure.

Among patients with RA treated in placebo-controlled studies, serious adverse events occurred at a frequency of 4% in 349 patients treated with ENBREL compared to 5% of 152 placebo-treated patients. In a subsequent study (Study III), serious adverse events occurred at a frequency of 6% in 415 patients treated with ENBREL compared to 8% of 217 methotrexate-treated patients. In long-term open-label studies in adults with RA, there were no new or unexpected serious adverse events reported. Among adult patients with PsA, serious adverse events occurred at a frequency of 4% in 101 patients treated with ENBREL compared to 4% of 104 placebo-treated patients.

In controlled trials of adult PsO, rates of serious adverse events were seen at a frequency of < 1.5% among ENBREL and placebo-treated patients in the first 3 months of treatment. However, in patients greater than 65 years of age treated with ENBREL 50 mg twice weekly, serious adverse events occurred at a higher rate than in younger patients.

In long-term open-label trials of adult PsO, serious non-infectious adverse events were infrequent and exposure-adjusted event rates generally remained stable throughout ENBREL treatment. Although data for patients aged 65 or greater in the long-term trials are limited, adverse events, including serious adverse events, occurred at a higher frequency for patients treated with 50 mg twice weekly.

Among RA patients in placebo-controlled, active-controlled, and open-label trials of ENBREL, infections and malignancies were the most common serious adverse events observed. Other infrequent serious adverse events observed in RA, PsA, AS or PsO clinical trials are listed below by body system:

Cardiovascular: cardiomyopathy, fainting, heart failure, hypertension, hypotension, myocardial infarction, myocardial ischemia, deep vein thrombosis, thrombophlebitis

Digestive: cholecystitis, diarrhea, esophageal ulcer, gastrointestinal hemorrhage, pancreatitis, appendicitis

General:	impaired healing, asthenia
Hematologic/Lymphatic:	lymphadenopathy, myelodysplastic syndrome, necrotizing granulomatous lymphadenitis
Hepatic:	hepatic disorder, hepatic steatosis
Musculoskeletal:	bursitis, fistula, fracture nonunion, polymyositis
Nervous:	anxiety, cerebral ischemia, convulsion, depression, multiple sclerosis
Respiratory:	asthma, dyspnea, pulmonary embolism, sarcoidosis
Skin:	worsening psoriasis
Urogenital:	membranous glomerulonephropathy, kidney calculus

In a randomized controlled trial in which 51 patients with RA received ENBREL 50 mg twice weekly and 25 patients received ENBREL 25 mg twice weekly, the following serious adverse events were observed in the 50 mg twice weekly arm: gastrointestinal bleeding, normal pressure hydrocephalus, seizure, and stroke. No serious adverse events were observed in the 25 mg arm.

In controlled trials, the proportion of patients who discontinued treatment due to adverse events was approximately 4% in both the ENBREL and placebo treatment groups. The vast majority of these patients were treated with the recommended dose of 25 mg SC twice weekly. In adult PsO studies, ENBREL doses studied were 25 mg SC once or twice a week and 50 mg SC once or twice a week. In three randomized, placebo-controlled studies of adult patients with PsO, the safety profile for patients receiving 50 mg twice a week was similar to those receiving 25 mg once or twice weekly, and all were similar to placebo. No cumulative toxicities were observed in long term studies in adult patients with PsO up to 144 weeks and AS up to 192 weeks.

Among patients with RA in placebo-controlled studies, deaths occurred in 10 of 2696 (0.37%) ENBREL-treated patients compared to 3 of 1167 (0.26%) placebo-treated patients. In controlled and uncontrolled RA studies there were 58 deaths in 6973 patient treated with at least one dose of ENBREL over an exposure period of 11,765 patient-years (exposure-adjusted rate of 0.49). In the long-term open-label RA studies, the rate of death did not increase over time with increasing exposure to ENBREL. Among patients with PsO in placebo-controlled studies, deaths occurred in 1 of 1245 (0.08%) ENBREL-treated patients compared to 0 of 720 placebo-treated patients. In controlled and uncontrolled PsO studies there were 10 deaths in 4361 patients treated with at least one dose of ENBREL over an exposure period of 3966 patient-years (exposure-adjusted rate of 0.25). No deaths were reported in PsA, AS, or JIA studies.

8.2 Clinical Trial Adverse Reactions

Because clinical trials are conducted under very specific conditions, the adverse reaction rates observed in the clinical trials may not reflect the rates observed in practice and should not be compared to the rates in the clinical trials of another drug. Adverse reaction information from clinical trials is useful for identifying drug-related adverse events and for approximating rates.

Adverse reactions reported in at least 1% of all patients who received ENBREL in placebo-controlled RA trials (including the combination methotrexate trial) are outlined in Table 1 below. Adverse reactions reported in JIA, adult PsA, AS, and adult PsO trials were similar to those reported in RA clinical trials.

Table 1. Percent of Rheumatoid Arthritis Patients Reporting Adverse Reactions \geq 1% by Body System and Preferred Term in Controlled Clinical Trials^a

BODY SYSTEM Preferred Term	Placebo-Controlled Percent of patients		Active-Controlled Percent of patient	
	Placebo (N = 152)	Etanercept (N = 349)	Methotrexate (N = 217)	Etanercept (N = 415)
Injection Site Reaction	10	37	7	33
Infection^b	32	35	72	64
Non-upper respiratory infection ^c	31	39	60	51
Upper respiratory infection ^c	16	29	39	31
Other Adverse Events				
Body as a Whole				
Headache	3	3	13	12
Asthenia	0	1	7	5
Abdominal pain	1	1	5	4
Injection site hemorrhage	0	0	2	4
Pain	1	0	1	1
Mucous membrane disorder	0	1	2	0
Chills	0	0	2	0
Face edema	0	0	1	0
Fever	0	0	1	0
Cardiovascular System				
Vasodilation	1	1	1	1
Hypertension	0	0	0	1
Digestive System				
Nausea	3	2	18	9
Diarrhea	1	1	5	7
Dyspepsia	0	0	3	6
Mouth ulcer	0	1	11	4
Constipation	1	0	3	2
Vomiting	0	0	4	1
Anorexia	0	0	2	1
Flatulence	0	0	2	1
Stomatitis aphthous	0	0	2	1
Dry mouth	0	1	0	1
Stomatitis	0	0	3	0
Hemic & Lymphatic System				
Ecchymosis	1	0	2	2

BODY SYSTEM Preferred Term	Placebo-Controlled Percent of patients		Active-Controlled Percent of patient	
	Placebo (N = 152)	Etanercept (N = 349)	Methotrexate (N = 217)	Etanercept (N = 415)
Metabolic & Nutritional Disorders				
Peripheral edema	0	0	1	2
Weight increased	0	0	1	1
Abnormal healing	0	0	1	0
Musculoskeletal System				
Leg cramps	0	1	1	0
Nervous System				
Dizziness	1	3	5	5
Vertigo	0	0	0	1
Respiratory System				
Rhinitis	2	2	5	4
Dyspnea	0	0	1	3
Pharyngitis	0	1	2	2
Cough increased	1	1	2	1
Epistaxis	0	0	3	0
Voice alteration	0	0	1	0
Skin & Appendages				
Rash	2	3	10	6
Alopecia	0	1	11	5
Pruritus	1	2	1	2
Urticaria	1	0	2	1
Sweat	0	0	1	1
Nail disorder	0	0	2	0
Special Senses				
Dry eye	0	0	0	1
Tinnitus	0	0	0	1
Amblyopia	0	0	1	0

^a Includes data from the double-blinded studies in which patients received concurrent methotrexate therapy.

^b Infection (total) includes data from all three placebo-controlled trials. Body system and relationship to study drug was not collected for infections.

^c Non-URI and URI include data only from two placebo-controlled trials where infections were collected separately from adverse events (Placebo N = 110, Etanercept N = 213).

N = Number of patients having received at least 1 dose of study drug

% = n/N*100

Injection Site Reactions

In controlled trials in rheumatologic indications, approximately 37% of patients treated with ENBREL developed injection site reactions. In controlled trials in adult patients with PsO, approximately 14% of patients treated with ENBREL developed injection site reactions during the first 3 months of treatment. In a long-term PsO study the exposure-adjusted rate of

injections site reactions was 12.2 per 100 patient-years for patients treated with ENBREL 50 mg twice weekly over 96 weeks compared to 6.1 per 100-patient-years for placebo-treated patients (treated for 12 weeks). All injection site reactions were described as mild to moderate (erythema and/or itching, pain, or swelling). Injection site reactions generally occurred in the first month, if they occurred at all, did not necessitate study drug discontinuation, and subsequently decreased in frequency after the first month. The mean duration was 3 to 5 days. No treatment was given for approximately 90% of injection site reactions, and most of the patients who were given treatment received topical preparations, such as corticosteroids, or oral antihistamines. There have been common occurrences (7%) of redness at a previous injection site when subsequent injections were given; however, no intervention was necessary. In post-marketing experience, there have been reported cases (1.8% of all patients treated) of injection site bleeding and bruising observed in conjunction with ENBREL therapy.

Infections

The percent of adult patients reporting infections in controlled studies of ENBREL in PsO, RA, PsA and AS is provided in Table 2. The most common type of infection was upper respiratory infection.

Table 2. Percent of Patients Reporting Infections Across Controlled Studies in Psoriasis, Rheumatoid Arthritis, Psoriatic Arthritis and Ankylosing Spondylitis

	Event		
	Total Infections	Non-URI	URI
Psoriasis			
Placebo (N = 721)	26%	17%	9%
ENBREL (N = 1244)	30%	21%	10%
Rheumatoid Arthritis (Placebo-Controlled)			
Placebo (N = 152)	32%	31%	16%
ENBREL (N = 349)	35%	39%	29%*
Rheumatoid Arthritis (Active-Controlled)			
MTX (N = 217)	72%	60%	39%
ENBREL (N = 415)	64%*	51%	31%
Psoriatic Arthritis			
Placebo (N = 104)	43%	20%	23%
ENBREL (N = 101)	40%	19%	21%
Ankylosing Spondylitis			
Placebo (N = 139)	30%	20%	12%
ENBREL (N = 138)	41%	24%	20%*

URI = Upper Respiratory Infection

*Fisher's exact p-value < 0.05

For dose and regimen of ENBREL in each indication, please refer to Part II Clinical Trials section.

In placebo-controlled trials in RA, PsA, AS, and PsO no increase in the incidence of serious infections was observed (approximately 1% in both placebo- and ENBREL-treated groups). In all clinical trials in RA, serious infections experienced by patients have included pyelonephritis, bronchitis, septic arthritis, abdominal abscess, cellulitis, osteomyelitis, wound infection, pneumonia, foot abscess, leg ulcer, diarrhea, sinusitis and sepsis. The rate of serious infections

has not increased in open-label extension trials and is similar to that observed in controlled trials (Table 3). Serious infections, including sepsis and death, have also been reported during post-marketing use of ENBREL. Some have occurred within a few weeks after initiating treatment with ENBREL. Many of the patients had underlying conditions (eg, diabetes, congestive heart failure, history of active or chronic infections) in addition to their RA. Data from a sepsis clinical trial not specifically in patients with RA suggest that ENBREL treatment may increase mortality in patients with established sepsis.

Table 3. Serious Infections Over Time

Year	Number of patients	All ENBREL* (N = 1341)	
		Number of patients with events	Incidence rate
1	1341	35	0.026
2	1113	26	0.023
3	1006	26	0.026
4	915	25	0.027
5	849	27	0.032
6	769	22	0.029
7	696	21	0.030
8	647	24	0.037
9	608	16	0.026
10	529	15	0.028

*Controlled trials and open-label extension studies in RA.

In controlled trials in adult patients with PsA, there were no differences in rates of infection among patients treated for up to 1 year with ENBREL and those treated with placebo, and no serious infections occurred in patients treated with ENBREL.

In a controlled trial in patients with AS, rates of infection were also similar to those observed in the controlled studies of patients with RA or PsA. No increase in the incidence of serious infections was observed in patients treated with ENBREL.

In clinical trials in PsO, serious infections experienced by ENBREL-treated adult patients have included cellulitis, gastroenteritis, pneumonia, abscess, osteomyelitis, viral meningitis, myositis, fascial infection and septic shock.

In 2 studies in which patients were receiving both etanercept and anakinra for up to 24 weeks, the incidence of serious infections was 7%. The most common infections consisted of bacterial pneumonia (4 cases) and cellulitis (4 cases). One patient with pulmonary fibrosis and pneumonia died due to respiratory failure.

In global ENBREL clinical studies of 20,070 patients (28,308 patient-years of therapy), tuberculosis was observed in approximately 0.01% of patients. In 15,438 patients (23,524 patient-years of therapy) from clinical studies in the US and Canada, tuberculosis was observed in approximately 0.007% of patients. These studies include reports of pulmonary and extra-pulmonary tuberculosis (see **WARNINGS AND PRECAUTIONS, Serious and Opportunistic Infections**).

In 38 ENBREL clinical trials and 4 cohort studies in all approved indications representing 27,169 patient-years of exposure (17,696 patients) from the United States and Canada, no histoplasmosis infections were reported among patients treated with ENBREL. Data from clinical studies and post-marketing reports suggest that differences may exist in the risk of

invasive histoplasmosis infection among TNF-blockers. Nonetheless, post-marketing cases of serious and sometimes fatal fungal infections, including histoplasmosis, have been reported with TNF-blockers, including ENBREL (see **WARNINGS AND PRECAUTIONS, Serious and Opportunistic Infections**).

In post-marketing experience infections have been observed with various pathogens including viral, bacterial, mycobacterial, invasive fungal, and parasitic (including protozoal) organisms. Infections, including opportunistic infections (including atypical mycobacterial infection, herpes zoster, aspergillosis, *Pneumocystis jiroveci* pneumonia, histoplasmosis, candidiasis, coccidioidomycosis, listeriosis and legionellosis), have been reported in patients receiving ENBREL alone or in combination with immunosuppressive agents.

Malignancies

Information is available from 10,953 adult patients with 17,123 patient-years and 1154 pediatric patients with 2039 patient-years of experience across 45 ENBREL clinical studies.

In an open-label extension study that followed 581 DMARD-refractory RA patients for more than 10 years, the standardized incidence ratio (SIR) for all malignancies with respect to corresponding SEER rate was 1.30 with the 95% confidence interval (CI) of 0.97 to 1.71. In an open-label extension study that followed 468 early active RA patients for up to 9.6 years, the SIR for all malignancies with respect to corresponding SEER rate was 1.39 with the 95% CI of 0.98 to 1.93.

Lymphomas

An increased rate of lymphoma up to several-fold has been reported in the RA patient population, and may be further increased in patients with more severe disease activity.

In the controlled portions of clinical trials of TNF-blocking agents, more cases of lymphoma have been observed among patients receiving a TNF-blocker compared to control patients. During the controlled portions of ENBREL trials in adult patients with RA, AS, and PsA, 2 lymphomas were observed among 3306 ENBREL-treated patients versus 0 among 1521 control patients (duration of controlled treatment ranged from 3 to 36 months).

Among 6543 adult rheumatology (RA, PsA, AS) patients treated with ENBREL in controlled and uncontrolled portions of clinical trials, representing approximately 12,845 patient-years of therapy, the observed rate of lymphoma was 0.10 cases per 100 patient-years. This was 3-fold higher than the rate of lymphoma expected in the general population based on the SEER database.

In an open-label extension study that followed 581 DMARD-refractory RA patients for more than 10 years, the SIR for lymphomas with respect to corresponding SEER rate was 4.49 with a 95% CI of 1.81 to 9.26. In an open-label extension study that followed 468 early active RA patients for up to 9.6 years, the SIR for lymphomas with respect to corresponding SEER rate was 7.76 with a 95% CI of 3.35 to 15.30.

Among 4410 adult PsO patients treated with ENBREL in clinical trials up to 36 months, representing approximately 4278 patient-years of therapy, the observed rate of lymphoma was 0.05 cases per 100 patient-years, which is comparable to the rate in the general population. No cases were observed in ENBREL or placebo-treated patients during the controlled portions of these trials.

Leukemia

Cases of acute and chronic leukemia have been reported in association with post-marketing TNF-blocker use in RA and other indications. Even in the absence of TNF-blocker therapy, patients with RA may be at higher risk (approximately 2-fold) than the general population for the development of leukemia.

During the controlled portions of ENBREL trials, 2 cases of leukemia were observed among 5445 (0.06 cases per 100 patient-years) ENBREL-treated patients versus 0 among 2890 (0%) control patients (duration of controlled treatment ranged from 3 to 48 months).

Among 15,401 patients treated with ENBREL in controlled and open portions of clinical trials representing approximately 23,325 patient-years of therapy, the observed rate of leukemia was 0.03 cases per 100 patient-years.

Other Malignancies

For malignancies other than lymphoma and non-melanoma skin cancer, there was no difference in exposure-adjusted rates between the ENBREL and control arms in the controlled portions of clinical studies for all indications. Analysis of the malignancy rate in combined controlled and uncontrolled portions of studies has demonstrated that types and rates are similar to what is expected in the general population based on the SEER database and suggest no increase in rates over time.

Whether treatment with ENBREL might influence the development and course of malignancies in adults is unknown.

Melanoma and Non-melanoma skin cancer (NMSC)

Melanoma and non-melanoma skin cancer (NMSC) have been reported in patients treated with TNF-blockers, including ENBREL. Among 15,401 patients treated with ENBREL in controlled and open portions of clinical trials representing approximately 23,325 patient-years of therapy, the observed rate of melanoma was 0.043 cases per 100 patient-years. Among 3306 adult rheumatology (RA, PsA, AS) patients treated with ENBREL in controlled clinical trials, representing approximately 2669 patient-years of therapy, the observed rate of NMSC was 0.41 cases per 100 patient-years vs. 0.37 cases per 100 patient-years among 1521 control patients representing 1077 patient-years. Among 1245 adult PsO patients treated with ENBREL in controlled clinical trials, representing approximately 283 patient-years of therapy, the observed rate of NMSC was 3.54 cases per 100 patient-years vs. 1.28 cases per 100 patient-years among 720 control patients representing 156 patient-years.

Among 89 patients with granulomatosis with polyangiitis receiving ENBREL in a randomized, placebo-controlled trial, 5 experienced a variety of non-cutaneous solid malignancies compared with none receiving placebo (see **WARNINGS AND PRECAUTIONS, Granulomatosis with Polyangiitis**).

Autoantibodies

Patients had serum samples tested for autoantibodies at multiple time points. In RA Studies I and II, the percentage of patients evaluated for antinuclear antibodies (ANA) who developed new positive ANA (1:40) was higher in patients treated with ENBREL (11%) than in placebo-treated patients (5%). The percentage of patients who developed new positive anti-double-stranded DNA antibodies was also higher by radioimmunoassay (15% of patients treated with ENBREL compared to 4% of placebo-treated patients) and by *Crithidia luciliae* assay (3% of patients treated with ENBREL compared to none of placebo-treated patients). The proportion of

patients treated with ENBREL who developed anticardiolipin antibodies was similarly increased compared to placebo-treated patients. In Study III, no pattern of increased autoantibody development was seen in ENBREL patients compared to methotrexate patients.

The impact of long-term treatment with ENBREL on the development of autoimmune diseases is unknown. Rare adverse event reports have described patients with rheumatoid factor positive and/or erosive RA who have developed additional autoantibodies in conjunction with rash and other features suggesting a lupus-like syndrome.

Immunogenicity

Adult patients with RA, PsA, AS or PsO were tested at multiple time points for antibodies to ENBREL. Non-neutralizing antibodies to the TNF receptor portion or other protein components of the ENBREL drug product were detected at least once in sera of approximately 6% of adult patients with RA, PsA, AS or PsO. All antibodies were non-neutralizing. Results from pediatric JIA patients were similar to those seen in adult RA patients treated with ENBREL.

In adult long-term PsO studies up to 144 weeks, the percentage of patients testing positive at any time point assessed was 3%-10%. In pediatric PsO studies, approximately 10% of subjects developed antibodies to etanercept by Week 48 and approximately 16% of subjects developed antibodies to etanercept by Week 264. All of these antibodies were non-neutralizing. In all clinical studies with ENBREL to date, there has been no apparent correlation of antibody development to clinical response or adverse events. Neutralizing antibodies have not been observed with ENBREL.

The data reflect the percentage of patients whose test results were considered positive for antibodies to ENBREL in an ELISA assay and are highly dependent on the sensitivity and specificity of the assay. Additionally, the observed incidence of any antibody positivity in an assay is highly dependent on several factors including assay sensitivity and specificity, assay methodology, sample handling, timing of sample collection, concomitant medications, and underlying disease. For these reasons, comparison of the incidence of antibodies to ENBREL with incidence of antibodies to other products may be misleading.

Patients with Heart Failure

Two randomized placebo-controlled studies have been performed in patients with CHF. In one study, patients received either ENBREL 25 mg twice weekly, 25 mg three times weekly, or placebo. In a second study, patients received either ENBREL 25 mg once weekly, 25 mg twice weekly, or placebo. Results of the first study suggested higher mortality in patients treated with ENBREL at either schedule compared to placebo. Results of the second study did not corroborate these observations. Analyses did not identify specific factors associated with increased risk of adverse outcomes in heart failure patients treated with ENBREL (see **WARNINGS AND PRECAUTIONS, Cardiovascular**).

Other

In a study with etanercept manufactured by a modified process (see **CLINICAL TRIALS, Other Studies**) major adverse events included the following. Twelve patients (5.4%) experienced 13 serious adverse events. One patient experienced a benign lung neoplasm. One patient (0.4%) experienced a life-threatening non-infectious event (pulmonary embolism) and 14 patients (6.3%) experienced severe non-infectious adverse events. One serious event (urinary tract infection) was considered infectious. One adverse event of hepatic neoplasm malignant (serious) and one squamous cell carcinoma (non-serious) were reported. Overall, the safety profile was comparable to the etanercept manufactured using the previous process.

8.2.1 Clinical Trial Adverse Reactions - Pediatrics

In general, the adverse events in pediatric patients were similar in frequency and type as those seen in adult patients. Differences from adult and other special considerations are discussed in the following paragraphs.

Severe adverse reactions reported in 69 JIA patients aged 4 to 17 years included varicella, gastroenteritis, depression/personality disorder, cutaneous ulcer, esophagitis/gastritis, group A streptococcal septic shock, type I diabetes mellitus, and soft tissue and post-operative wound infection.

Forty-three of 69 (62%) children with JIA experienced an infection while receiving ENBREL during the 3 months of the study (part 1 open-label), and the frequency and severity of infections was similar in 58 patients completing 12 months of open-label extension therapy. The types of infections reported in pediatric patients with JIA and PsO were generally mild and consistent with those commonly seen in outpatient pediatric populations.

The following adverse events were reported more commonly in 69 JIA patients receiving 3 months of ENBREL compared to the 349 adult RA patients in placebo-controlled trials. These included headache (19% of patients, 1.7 events per patient-year), nausea (9%, 1.0 events per patient-year), abdominal pain (19%, 0.74 events per patient-year), and vomiting (13%, 0.74 events per patient-year).

In open-label clinical studies of children with JIA, adverse events reported in those aged 2 to 4 years were similar to adverse events reported in older children.

In a 48-week clinical study in 211 children aged 4 to 17 years with pediatric PsO, the adverse reactions reported were similar to those seen in previous studies in adults with PsO. Long-term safety profile for up to 264 additional weeks was assessed in an open-label extension study. No new safety signals were identified.

In controlled clinical trials in pediatric PsO, 7% of patients treated with ENBREL developed injection site reactions during the first 3 months of treatment. All injection site reactions were described as mild to moderate (erythema, itching, pain, swelling, bleeding, bruising) and generally did not necessitate drug discontinuation.

In post-marketing experience, the following additional serious adverse events have been reported in pediatric JIA patients: abscess with bacteremia, optic neuritis, pancytopenia, neutropenia, leukopenia, thrombocytopenia, anemia, seizures, tuberculous arthritis, urinary tract infection including urosepsis, coagulopathy, cutaneous vasculitis, bronchitis, gastroenteritis, and transaminase elevation. Other significant adverse events have included depression. The frequency of these events and their causal relationship to ENBREL therapy is unknown.

The long-term effects of ENBREL therapy on skeletal, behavioural, cognitive, sexual and immune maturation and development in children are unknown.

A higher rate of adverse events was noted when JIA patients in an observational registry received ENBREL therapy in combination with methotrexate. As the JIA patients receiving combination therapy had more severe disease, since they had failed prior therapeutic trials with either ENBREL or methotrexate alone, it remains unclear whether the higher event rate is related to therapy or underlying disease severity.

8.3 Less Common Clinical Trial Adverse Reactions

The following adverse reactions were reported at an incidence of < 1% (occurring in more than 1 patient, with higher frequency than placebo):

Body as a Whole: enlarged abdomen, general edema, hernia, infection, injection site reaction, malaise, overdose, Sjogrens syndrome;

Cardiovascular: cerebrovascular accident, hypotension, myocardial infarction, phlebitis, deep thrombophlebitis;

Gastrointestinal: increased appetite, colitis, dysphagia, glossitis, gum hemorrhage, rectal hemorrhage;

Hemic and Lymphatic System: petechia;

Metabolic and Nutritional Disorders: edema, hypercholesteremia, hyperglycemia;

Musculoskeletal System: arthrosis, bone disorder, fibrosis tendon, bone necrosis;

Nervous System: nervousness, neuropathy;

Respiratory System: bronchitis, lung carcinoma, hemoptysis, laryngitis;

Skin and Appendages: skin carcinoma, dermatitis exfoliative, skin hypertrophy, skin discolouration, skin ulcer;

Special Senses: corneal lesion, ear disorder, eye hemorrhage, otitis media;

Urogenital System: cervix disorder, cystitis, dysuria, gynecomastia, uterine hemorrhage, kidney polycystic, cervix neoplasm, polyuria, urine urgency.

8.5 Post-Market Adverse Reactions

Additional adverse events have been identified during post-marketing use of ENBREL. Because these events are reported voluntarily from a population of uncertain size, it is not always possible to reliably estimate their frequency or establish a causal relationship to ENBREL exposure. These adverse events include, but are not limited to, the following (listed by body system):

Body as a Whole:	angioedema, fatigue, fever, flu syndrome, generalized pain, weight gain
Cardiovascular:	chest pain, vasodilation (flushing), new-onset congestive heart failure
Digestive:	altered sense of taste, anorexia, diarrhea, dry mouth, intestinal perforation
Gastrointestinal:	Inflammatory bowel disease (IBD)
Hematologic/Lymphatic:	adenopathy, anemia, aplastic anemia, leukopenia, neutropenia, pancytopenia, thrombocytopenia
Hepatobiliary:	autoimmune hepatitis, elevated transaminase, hepatitis B reactivation
Immune:	macrophage activation syndrome, systemic vasculitis
Musculoskeletal:	joint pain, lupus-like syndrome

Neoplasms benign, malignant and unspecified:	Merkel cell carcinoma
Nervous:	paresthesias, stroke, seizures and central nervous system events suggestive of multiple sclerosis or isolated demyelinating conditions such as transverse myelitis or optic neuritis
Ocular:	dry eyes, ocular inflammation, scleritis, uveitis
Respiratory:	dyspnea, interstitial lung disease, pulmonary disease, worsening of prior lung disorder
Skin:	cutaneous lupus erythematosus, cutaneous vasculitis, including leukocytoclastic vasculitis (with several symptom manifestations), erythema multiforme, Stevens-Johnson syndrome, toxic epidermal necrolysis, pruritus, subcutaneous nodules, urticaria, new or worsening psoriasis (all sub-types including pustular and palmoplantar)

9 DRUG INTERACTIONS

9.2 Drug Interactions Overview

Specific drug interaction studies have not been conducted with ENBREL. ENBREL has not been formally evaluated in combination with other DMARDs such as gold, antimalarials, sulfasalazine, penicillamine, azathioprine, cyclophosphamide, or leflunomide and the benefits and risks of such combinations are unknown.

9.4 Drug-Drug Interactions

ENBREL can be used in combination with methotrexate in adult patients with RA or PsA.

No clinically significant pharmacokinetic drug-drug interactions were observed in studies with digoxin and warfarin.

A higher rate of adverse events was noted when JIA patients in an observational registry received ENBREL therapy in combination with methotrexate. As the JIA patients receiving combination therapy had more severe disease, since they had failed prior therapeutic trials with either ENBREL or methotrexate alone, it remains unclear whether the higher event rate is related to therapy or underlying disease severity.

Patients in a clinical study who were on established therapy with sulfasalazine, to which ENBREL was added, experienced a statistically significant decrease in mean white blood cell counts in comparison to groups treated with either ENBREL or sulfasalazine alone. The significance of this observation is unknown.

Concurrent introduction of etanercept and anakinra therapies has not been associated with increased clinical benefit to patients. In a study in which patients with active RA were treated for up to 24 weeks with concurrent ENBREL and anakinra therapy, a 7% rate of serious infections was observed, which was higher than that observed with ENBREL alone (0%). Two percent of patients treated concurrently with ENBREL and anakinra developed neutropenia (ANC < 1 x 10⁹/L).

In a study of patients with granulomatosis with polyangiitis, the addition of ENBREL to standard therapy (including cyclophosphamide) was associated with a higher incidence of non-cutaneous malignancies. Although the role of ENBREL in this finding is uncertain, the use of ENBREL in any patients receiving concurrent cyclophosphamide therapy is not recommended.

In clinical studies, concurrent administration of abatacept and ENBREL resulted in increased incidences of serious adverse events and did not demonstrate increased clinical benefit. Use of ENBREL with abatacept is not recommended.

10 CLINICAL PHARMACOLOGY

10.1 Mechanism of Action

ENBREL (etanercept) is a dimeric fusion protein consisting of the extracellular ligand-binding portion of the human 75 kilodalton (p75) tumour necrosis factor receptor (TNFR) linked to the Fc portion of human IgG1. It consists of 934 amino acids and has an apparent molecular weight of approximately 150 kilodaltons.

Etanercept binds specifically to soluble and cell surface tumour necrosis factor (TNF) and blocks its interaction with cell surface TNF receptors. Etanercept inactivates TNF without causing *in vitro* lysis of cells involved in the immune response. TNF is a naturally occurring cytokine, or immune system protein, that is implicated in the development and progression of inflammatory, infectious, and autoimmune diseases. TNF plays an important role in the inflammatory processes of RA, polyarticular JIA, AS and the resulting joint pathology. In addition, TNF plays an important role in the inflammatory process of PsO and resulting skin pathology. Elevated levels of TNF are found in the synovial fluid of RA patients, in both the synovium and psoriatic plaques of patients with PsA and PsO and in serum and synovial tissue of patients with AS. In PsO, infiltration by inflammatory cells including T-cells leads to increased TNF levels in psoriatic lesions, compared with levels in uninvolved skin.

Two distinct receptors for TNF (TNFRs), a 55 kilodalton protein (p55) and a 75 kilodalton protein (p75), exist naturally as monomeric molecules on cell surfaces and in soluble forms. Biological activity of TNF is dependent upon binding to either cell surface TNFR.

Etanercept is a dimeric soluble form of the p75 TNF receptor that can bind to two TNF molecules. This dimeric binding provides substantially greater competitive inhibition of TNF than monomeric soluble receptors.

Much of the joint pathology in RA is mediated by proinflammatory molecules that are linked in a network controlled by TNF.

Etanercept competitively inhibits binding of both TNF α and TNF β (lymphotoxin α [LT α]) to cell surface TNF receptors, rendering TNF biologically inactive. Etanercept does not cause lysis of TNF-producing cells *in vitro*, in the presence or absence of complement.

10.2 Pharmacodynamics

Etanercept also modulates biological responses that are induced or regulated by TNF, including expression of adhesion molecules responsible for leukocyte migration (ie, E-selectin and to a lesser extent intercellular adhesion molecule-1 [ICAM-1]), serum levels of cytokines (eg, IL-6, IL-1), and serum levels of matrix metalloproteinase-3 (MMP-3 or stromelysin). Etanercept has been shown to affect several animal models of inflammation, including murine collagen-induced arthritis.

10.3 Pharmacokinetics

After administration of 25 mg ENBREL by a single subcutaneous (SC) injection to 25 patients with RA, a mean \pm standard deviation half-life of 102 ± 30 hours was observed with a clearance of 160 ± 80 mL/hr. A maximum serum concentration (C_{\max}) of 1.1 ± 0.6 mcg/mL and time to C_{\max} of 69 ± 34 hours was observed in these patients following a single 25 mg dose. After 6 months of twice weekly 25 mg doses in these same RA patients, the mean C_{\max} was 2.4 ± 1.0 mcg/mL (N = 23). Patients exhibited a two- to seven-fold increase in peak serum concentrations and approximately four-fold increase in $AUC_{0-72 \text{ hr}}$ (range 1 to 17 fold) with repeated dosing. Serum concentrations in patients with RA have not been measured for periods of dosing that exceed 6 months.

In another study, serum concentration profiles at steady state were comparable among patients with RA treated with 50 mg ENBREL once weekly and those treated with 25 mg ENBREL twice weekly. The mean (\pm standard deviation) C_{\max} , C_{\min} , and partial AUC were 2.4 ± 1.5 mg/L, 1.2 ± 0.7 mg/L, and 297 ± 166 mg•h/L, respectively, for patients treated with 50 mg ENBREL once weekly (N = 21); and 2.6 ± 1.2 mg/L, 1.4 ± 0.7 mg/L, and 316 ± 135 mg•h/L for patients treated with 25 mg ENBREL twice weekly (N = 16). Serum concentrations in patients with PsO treated with 50 mg ENBREL twice weekly were approximately twice that of 25 mg ENBREL twice weekly treatment; mean (\pm SD) of 3.8 ± 1.9 mg/L and 1.9 ± 1.1 mg/L, at 12 weeks respectively.

Special Populations and Conditions

Pediatrics:

Pediatric patients with JIA (ages 4 to 17 years) were administered 0.4 mg/kg of ENBREL twice weekly (up to a maximum dose of 50 mg per week) for up to 18 weeks. The average serum concentration after repeated dosing was 2.1 mcg/mL, with a range of 0.7 to 4.3 mcg/mL compared to a serum concentration of 3.1 mcg/mL, with a range of 0.9 to 5.6 mcg/mL in adults. Preliminary data suggests that the clearance of ENBREL is reduced slightly in children ages 4 to 8 years. Population pharmacokinetic analyses predict that administration of 0.8 mg/kg of ENBREL once weekly in children will result in C_{\max} 11% higher, and C_{\min} 20% lower at steady state as compared to administration of 0.4 mg/kg of ENBREL twice weekly. The predicted pharmacokinetic differences between the regimens in JIA patients are of the same magnitude as the differences observed between twice weekly and weekly regimens in adult RA patients. Serum concentrations of ENBREL in children with JIA aged 2 to 4 were similar to serum concentrations of ENBREL in older children with JIA.

Pediatric patients with PsO (ages 4 to 17 years) were administered 0.8 mg/kg of ENBREL once weekly (up to a maximum dose of 50 mg per week) for up to 48 weeks. The mean serum steady-state trough concentrations ranged from 1.6 to 2.1 mcg/mL at weeks 12, 24, and 48. These mean concentrations in pediatric patients with PsO were similar to the concentrations observed in patients with JIA and adult patients with PsO.

Concomitant methotrexate does not alter the pharmacokinetics of ENBREL in adults. The pharmacokinetics of concomitant methotrexate in children with JIA ages 4 to 17 has not been evaluated.

Sex:

Pharmacokinetic parameters were not different between men and women and did not vary with age in adult patients.

Hepatic Insufficiency:

No formal pharmacokinetic studies have been conducted to examine the effect of hepatic impairment on ENBREL disposition or potential interactions with methotrexate.

Renal Insufficiency:

No formal pharmacokinetic studies have been conducted to examine the effect of renal impairment on ENBREL disposition or potential interactions with methotrexate.

11 STORAGE, STABILITY AND DISPOSAL

ENBREL Single-use Prefilled Syringe and ENBREL Single-use Prefilled SureClick®

Autoinjector: ENBREL should be stored refrigerated at 2°C to 8°C. **DO NOT FREEZE.** Keep the product in the original carton to protect from light until the time of use. Do not shake. Keep in a safe place out of the reach of children.

Do not use ENBREL beyond the expiration date stamped on the carton or syringe label. ENBREL may be transferred to room temperature storage ($\leq 27^{\circ}\text{C}$) for a period not to exceed 60 days. Once transferred to room temperature storage, ENBREL must be used within 60 days. Protect from direct sunlight, sources of heat, and humidity.

ENBREL Multiple-use Vial: The dose tray containing ENBREL should be stored refrigerated at 2°C to 8°C. **DO NOT FREEZE.** Do not use dose tray beyond the date stamped on the carton, dose tray label, vial label, or diluent syringe label. ENBREL Multiple-use Vial may be transferred to room temperature storage ($\leq 27^{\circ}\text{C}$) for a period not to exceed 60 days. Once transferred to room temperature storage, ENBREL must be used within 60 days. Protect from direct sunlight, sources of heat, and humidity.

ENBREL Multiple-use Vial (Reconstituted Solution): Reconstituted solutions of ENBREL prepared with the supplied Sterile Bacteriostatic Water for Injection, USP (0.9% benzyl alcohol) must be refrigerated in the original vial for not more than 14 days at 2°C to 8°C, with overall room temperature exposure of less than 12 hours during storage and handling/usage. **DO NOT FREEZE.** Discard reconstituted solution after 14 days.

Reconstituted product stability and sterility cannot be assured after 14 days.

12 SPECIAL HANDLING INSTRUCTIONS

Information to Patients

ENBREL is provided as a single-use prefilled syringe, a single-use prefilled SureClick[®] autoinjector, or a multiple-use vial. The following components contain dry natural rubber (a derivative of latex) that may cause allergic reactions in individuals sensitive to latex: the needle cover of the prefilled syringe and the needle cover within the needle cap of the SureClick[®] autoinjector.

If a patient or caregiver is to administer ENBREL, they should be instructed in injection techniques and how to measure the correct dose to ensure the safe administration of ENBREL. The first injection should be performed under the supervision of a qualified health care professional. The patient's or caregiver's ability to inject subcutaneously should be assessed. Alcohol swabs and cotton balls or gauze are required for the injections and will need to be obtained separately. A puncture-resistant container for disposal of needles, syringes, and autoinjectors should be used. Patients and caregivers should be instructed in the technique of proper syringe and needle disposal, and be cautioned against reuse of these items. If product is intended for multiple-use, additional syringes and needles will be required.

PART II: SCIENTIFIC INFORMATION

13 PHARMACEUTICAL INFORMATION

Drug Substance

Proper name: Etanercept

Chemical name: Not applicable. Etanercept is not a chemical. Etanercept is a Recombinant human Tumour Necrosis Factor Receptor: Fusion Protein (TNFR:Fc)

Molecular formula and molecular mass: Etanercept consists of 934 amino acids and has an apparent molecular weight of approximately 150 kilodaltons. The specific activity of etanercept is 1.7×10^6 U/mg.

Structural formula:

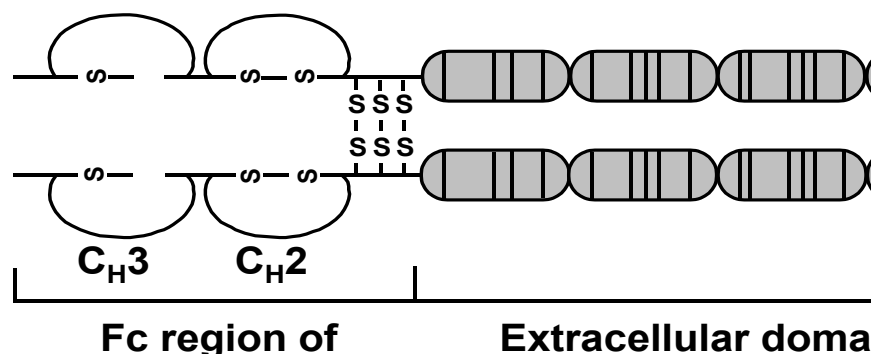

Physicochemical properties:

ENBREL is a clear and colourless, sterile, preservative free solution, and is formulated at pH 6.3 ± 0.2 .

ENBREL is a sterile, white, preservative-free, lyophilized powder in a multiple-use vial. Each vial is reconstituted with 1 mL of the supplied Sterile Bacteriostatic Water for Injection (BWFI), USP (containing 0.9% benzyl alcohol) to yield a multiple-use, clear and colourless solution, with a pH of 7.4 ± 0.3 .

Product Characteristics

ENBREL (etanercept) is a dimeric fusion protein consisting of the extracellular ligand-binding portion of the human p75 tumour necrosis factor receptor (TNFR) linked to the Fc portion of human IgG1 (see illustration above). Etanercept is produced by recombinant DNA technology in a Chinese hamster ovary (CHO) mammalian cell expression system for use as a therapeutic inhibitor of tumour necrosis factor (TNF), a proinflammatory cytokine. Etanercept is composed entirely of human amino acid sequences. The Fc component of etanercept contains the C_H2 and C_H3 domains but not the C_H1 domain of IgG1.

14 CLINICAL TRIALS

14.1 Adult Rheumatoid Arthritis (RA)

Study demographics and trial design

The safety and efficacy of ENBREL were assessed in four randomized, double blind, controlled studies and two long-term open-label studies. The results of all trials were expressed in percentage of patients with improvement in RA using American College of Rheumatology (ACR) response criteria.

Table 4. Summary of Patient Demographics for Clinical Trials in Patients with Rheumatoid Arthritis

Study #	Trial design	Dosage, route of administration and duration	Study patients (n)	Mean age (years)	Gender (% female)
Study I (Moreland et al, 1999)	Multicenter, double-blind, randomized placebo-controlled study	ENBREL 10 mg or 25 mg, or placebo; SC twice weekly for 6 months			
		ENBREL 10 mg:	76	53	84
		ENBREL 25 mg:	78	53	74
		Placebo:	80	51	76
Study II (Weinblatt et al, 1999)	Multicenter, double-blind, randomized placebo-controlled study	ENBREL 25 mg, or placebo; SC twice weekly for 6 months			
		ENBREL + MTX:	59	48	90
		Placebo + MTX:	30	53	73
Study III (Bathon et al, 2000)	Multicenter, double-blind, randomized active-controlled study	ENBREL 10 mg or 25 mg, or MTX, SC twice weekly for 12 months			
		ENBREL 10 mg:	208	50	75
		ENBREL 25 mg:	207	51	74
		MTX:	217	49	75
Study IV (Klareskog et al, 2004)	Multicenter, double-blind, randomized active-controlled study	ENBREL 25 mg alone, MTX alone, or ENBREL/MTX for 12 months			
		ENBREL 25 mg alone:	223	53	77
		MTX alone:	228	53	79
		ENBREL/MTX:	231	53	74

MTX = methotrexate; SC = subcutaneous

Study I evaluated 234 patients with active RA who were ≥ 18 years old, had failed therapy with at least one but no more than four disease-modifying antirheumatic drugs (DMARDs: eg, hydroxychloroquine, oral or injectable gold, methotrexate (MTX), azathioprine, penicillamine, sulfasalazine), and had ≥ 12 tender joints, ≥ 10 swollen joints, and either erythrocyte sedimentation rate (ESR) ≥ 28 mm/hr, C-reactive protein (CRP) > 2.0 mg/dL, or morning stiffness for ≥ 45 minutes. Doses of 10 mg or 25 mg ENBREL or placebo were administered subcutaneously (SC) twice a week for 6 consecutive months. Results from patients receiving 25 mg are presented in Table 5.

Study II evaluated 89 patients with similar inclusion criteria to Study I except that patients in Study II had additionally received MTX for at least 6 months, with a stable dose (12.5 to 25 mg/week) for at least 4 weeks, and they had at least 6 tender or painful joints. Patients in Study II received a dose of 25 mg ENBREL or placebo SC twice a week for 6 months in addition to their stable MTX dose.

Study III compared the efficacy of ENBREL to MTX in patients with active RA. This study evaluated 632 patients who were ≥ 18 years old with early (< 3 years disease duration) active RA; had never received treatment with MTX; and had ≥ 12 tender joints, ≥ 10 swollen joints, and either ESR ≥ 28 mm/hr, CRP > 2.0 mg/dL, or morning stiffness for ≥ 45 minutes. Doses of 10 mg or 25 mg ENBREL were administered SC twice a week for 12 consecutive months. The study was unblinded after all patients had completed at least 12 months (and a median of 17.3 months) of therapy. Results from patients receiving 25 mg are presented in Table 5. MTX tablets (escalated from 7.5 mg/week to a maximum of 20 mg/week over the first 8 weeks of the trial) or placebo tablets were given one a week on the same day as the injection of placebo or ENBREL doses, respectively.

After the conclusion of Study III, patients could continue in a long-term extension study. This multicenter, open-label extension study followed 468 patients (mean age 50 years, 75% female at baseline) from Study III for up to 9.6 years. All patients received open-label 25 mg ENBREL SC twice weekly, and were monitored to evaluate the effects of long-term ENBREL administration on safety, health-related quality of life, and prevention of disability. Structural damage as measured by radiographic progression and clinical activity were evaluated at the 5 year time point.

Study IV evaluated 682 adult patients with active RA of 6 months to 20 years duration (mean 7 years) who had an inadequate response to at least one DMARD other than MTX. A minority of patients (43%) had previously received MTX for a mean of two years prior to the trial at a mean dose of 12.9 mg. Patients were excluded from this study if MTX had been discontinued for lack of efficacy or for safety considerations.

Patients were randomized to MTX alone (7.5 to 20 mg weekly, median dose 20 mg), ENBREL alone (25 mg twice weekly), or the combination of ENBREL and MTX initiated concurrently (at the same doses as above). The study evaluated ACR response, Disease Activity Score (DAS), Sharp radiographic score and safety.

Another long-term extension study followed patients with DMARD-refractory RA (defined as less-than-optimal response to ≥ 1 previous DMARD) who had been enrolled from 8 previous ENBREL studies. This multicenter, long-term extension study evaluated the effectiveness and safety of more than 10 years of etanercept treatment in 581 patients (mean age 50 years, 80% female at baseline). Drug was administered as 50 mg weekly SC dose of etanercept as two 25 mg injections on the same day or 3 to 4 days apart. These patients were followed for up to 11.3 years to evaluate the long-term safety of etanercept and improvement in physical function (5-year evaluation)/disability and quality of life.

Study results

The percent of ENBREL-treated patients achieving ACR 20, 50, 70 responses was consistent across all 4 trials. The results of Studies I, II and III are summarized in Table 5. The results of Study IV are summarized in Table 7.

**Table 5. ACR Responses in Placebo- and Active-Controlled Trials
(Percent of Patients)**

Response	Placebo-Controlled				Active-Controlled	
	Study I		Study II		Study III*	
	Placebo N = 80	ENBREL ^a N = 78	MTX/ Placebo N = 30	MTX/ ENBREL ^a N = 59	MTX N = 217	ENBREL ^a N = 207
ACR 20						
Week 2	1%	32%	10%	47%	NA	NA
Month 3	23%	62% ^b	33%	66% ^b	56%	62%
Month 6	11%	59% ^b	27%	71% ^b	58%	65%
Month 12	NA	NA	NA	NA	65%	72%
ACR 50						
Week 2	0%	6%	0%	7%	NA	NA
Month 3	8%	41% ^b	0%	42% ^b	24%	29%
Month 6	5%	40% ^b	3%	39% ^b	32%	40%
Month 12	NA	NA	NA	NA	43%	49%
ACR 70						
Week 2	0%	1%	0%	3%	NA	NA
Month 3	4%	15% ^b	0%	15% ^b	7%	13% ^c
Month 6	1%	15% ^b	0%	15% ^b	14%	21% ^c
Month 12	NA	NA	NA	NA	22%	25%

ACR = American College of Rheumatology response criteria.; MTX = methotrexate; SC = Subcutaneous

^a 25 mg ENBREL SC twice weekly

^b p < 0.01, ENBREL vs. placebo

^c p < 0.05, ENBREL vs. MTX

* Study III was conducted in patients who were MTX naive.

The time course of ACR 20 response rates for patients receiving placebo or 25 mg ENBREL in Studies I and II is summarized in Figure 1. The time course of responses to ENBREL in Study III was similar.

Figure 1. Time Course of ACR 20 Responses

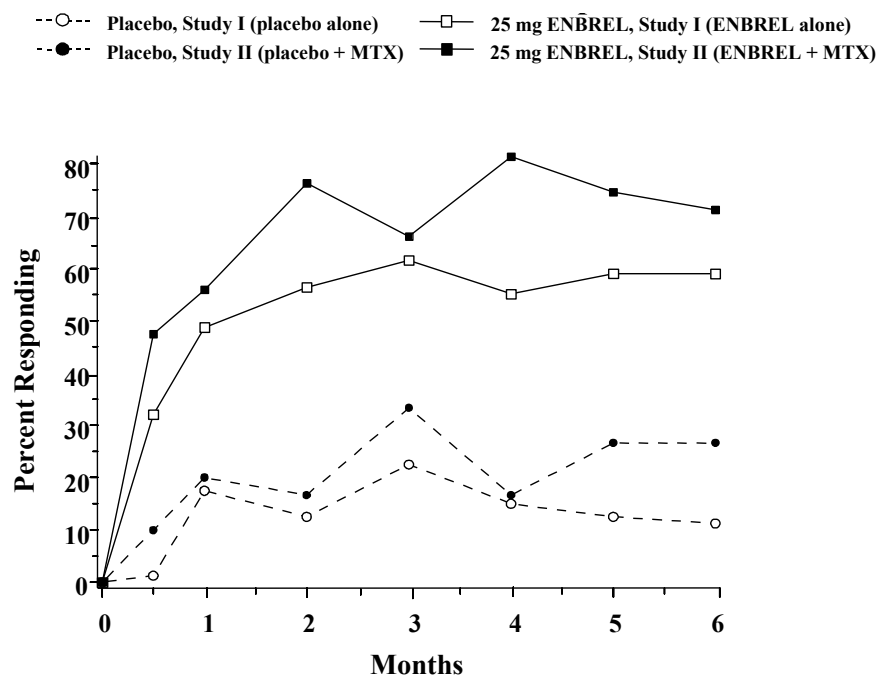

Among patients receiving ENBREL, the clinical responses generally appeared within 1 to 2 weeks after initiation of therapy and nearly always occurred by 3 months. A dose response was seen in Studies I and III: 25 mg ENBREL was more effective than 10 mg (10 mg was not evaluated in Study II). ENBREL was significantly better than placebo in all components of the ACR criteria as well as other measures of RA disease activity not included in the ACR response criteria, such as morning stiffness. Only a small number of patients were treated in the controlled clinical trial (Study II) with the combination of ENBREL and MTX (N = 59 for ENBREL/MTX combination; N = 30 for MTX alone) and for a relatively short period of time (6 months).

In Study III, ACR response rates and improvement in all the individual ACR response criteria were maintained through 24 months of ENBREL therapy. Over the 2-year study, 23% of ENBREL patients achieved a major clinical response, defined as maintenance of an ACR 70 response over a 6-month period.

In the open label extension for Study III, ACR 20, 50 and 70 responses were observed through 5 and 10 years. Of 468 patients, 297 patients continued on ENBREL treatment through 5 years. Of those, 61%, 49% and 30% had ACR 20, ACR 50, and ACR 70 responses, respectively, at 5 years. Of these 297 patients, 168 patients continued on ENBREL treatment through 9.6 years, of those, 66%, 46%, and 30% had ACR 20, ACR 50 and ACR 70 responses, respectively, at 9 years.

The results of the components of the ACR response criteria for Study I are shown in Table 6. Similar results were observed for ENBREL-treated patients in Studies II and III.

Table 6. Components of ACR Response in Study I

Parameter (median)	Placebo N = 80		ENBREL ^a N = 78	
	Baseline	3 months	Baseline	3 months*
No. of tender joints ^b	34	29.5	31.2	10.0 ^f
No. of swollen joints ^c	24	22	23.5	12.6 ^f
Physical global assessment ^d	7	6.5	7	3.0 ^f
Patient global assessment ^d	7	7	7	3.0 ^f
Pain ^d	6.9	6.6	6.9	2.4 ^f
Disability index ^e	1.7	1.8	1.6	1.0 ^f
ESR (mm/hr)	31	32	28	15.5 ^f
CRP (mg/dL)	2.8	3.9	3.5	0.9 ^f

ACR = American College of Rheumatology; CRP = C-reactive protein; ESR = erythrocyte sedimentation rate

* Results at 6 months showed similar improvement.

^a 25 mg ENBREL subcutaneous (SC) twice weekly.

^b Scale 0-71.

^c Scale 0-68.

^d Visual analog scale; 0 = best, 10 = worst.

^e Health assessment questionnaire; 0 = best, 3 = worst; includes eight categories: dressing and grooming, arising, eating, walking, hygiene, reach, grip, and activities.

^f $p < 0.01$, ENBREL vs. placebo, based on mean percent change from baseline.

An additional randomized, controlled, double-blind trial evaluated 180 patients with similar criteria to Study I. Doses of 0.25 mg/m², 2 mg/m², and 16 mg/m² ENBREL were administered SC twice a week for 3 consecutive months. A dose-dependent increase in the proportion of patients achieving an ACR 20 response was seen, with 75% of patients responding in the highest dose group (16 mg/m² ENBREL).

After discontinuation of ENBREL, symptoms of arthritis generally returned within a month. Reintroduction of treatment with ENBREL after discontinuations of up to 18 months resulted in the same magnitudes of response as patients who received ENBREL without interruption of therapy based on results of open-label studies.

Continued durable responses were also seen for approximately 10 years in a second open-label extension trial with ENBREL treatment. Of 581 patients, 365 patients continued on ENBREL treatment through 5 years. Of those, 73%, 49%, and 24% had ACR 20, ACR 50 and ACR 70 responses, respectively, at 5 years. Of the 365 patients, 225 patients continued on ENBREL treatment through 10 years. Of those, 71%, 52%, and 27% had ACR 20, ACR 50 and ACR 70 responses, respectively, at 10 years. Fifty seven to 83% of patients who initially received concomitant MTX or corticosteroids were able to reduce their doses or discontinue these concomitant therapies while maintaining their clinical response.

In Study IV, patients initiating the combination of ENBREL and MTX had significantly higher ACR 20, ACR 50, and ACR 70 responses and improvement for DAS scores at both 6 and 12 months than patients in either of the single therapy groups (Table 7). Twenty-four percent of patients treated with ENBREL and MTX concurrently achieved a major clinical response within 12 months.

The percentage of patients who achieved low disease activity (defined as DAS < 2.4) at 12 months was 35%, 39%, and 61% for patients in the MTX alone group, ENBREL alone group, and the ENBREL/MTX combination group, respectively. Remission (defined as DAS < 1.6) was experienced by 14%, 18%, and 37% of patients administered MTX alone, ENBREL alone, and ENBREL/MTX combination therapy, respectively.

Table 7. Study IV Clinical Efficacy Results: Comparison of MTX vs. ENBREL vs. ENBREL in Combination with MTX in Patients with Rheumatoid Arthritis of 6 Months to 20 Years Duration (Percent of Patients)

Endpoint	MTX (N = 228)	ENBREL (N = 223)	ENBREL/MTX (N = 231)
ACR N^a			
Month 6	12.2	14.7 ^b	18.3 ^{d,e}
Month 12	34.4	38.0	48.1 ^{d,e}
ACR 20			
Month 12	75%	76%	85% ^{c,d}
ACR 50			
Month 12	43%	48%	69% ^{d,e}
ACR 70			
Month 12	19%	24%	43% ^{d,e}
Major Clinical Response^g	6%	10%	24% ^f
DAS^a			
Baseline	5.5	5.7	5.5
Month 12	3.0	3.0	2.3 ^{d,e}

ACR = American College of Rheumatology response criteria; DAS = Disease Activity Score; MTX = methotrexate

^a Values are means.

^b $p < 0.01$ for comparisons of ENBREL vs MTX.

^c $p < 0.05$ for comparisons of ENBREL/MTX vs ENBREL.

^d $p < 0.01$ for comparisons of ENBREL/MTX vs MTX.

^e $p < 0.01$ for comparisons of ENBREL/MTX vs ENBREL.

^f $p < 0.001$ for comparisons of the ENBREL/MTX vs ENBREL alone or MTX alone.

^g Major clinical response is achieving an ACR 70 response for a continuous 6 month period.

Physical Function Response

In Studies I, II, and III, physical function and disability were assessed using the Health Assessment Questionnaire (HAQ). Additionally, in Study III, patients were administered the SF-36 Health Survey. In Studies I and II, patients treated with 25 mg ENBREL twice weekly showed greater improvement from baseline in the HAQ score beginning in month 1 through month 6 in comparison to placebo ($p < 0.001$) for the HAQ disability index (HAQ-DI) (where 0 = none and 3 = severe). In Study I, the mean improvement in the HAQ score from baseline to month 6 was 0.6 (from 1.6 to 1.0) for the 25 mg ENBREL group and 0 (from 1.7 to 1.7) for the placebo group. In Study II, the mean improvement from baseline to month 6 was 0.7 (from 1.5 to 0.7) for 25 mg ENBREL twice weekly. All subdomains of the HAQ in Studies I and III were improved in patients treated with ENBREL.

In Study III, patients treated with 25 mg ENBREL twice weekly showed greater improvement from baseline in SF-36 physical component summary score compared to ENBREL 10 mg twice weekly and no worsening in the SF-36 mental component summary score.

In open-label ENBREL studies, improvements in physical function and disability measures (HAQ-DI) have been maintained for over 10 years. In the first study in patients with DMARD-refractory RA for a mean of 13 years, the mean baseline HAQ-DI was 1.5 (measured prior to/on the day of the first dose of etanercept treatment in the etanercept-initiating study). At Year 10, the mean HAQ-DI was 1.0, a mean percent improvement of 21. In a second study in patients who had been diagnosed with RA for a mean of 3 years, the mean baseline HAQ-DI was 1.3. At Year 9, the mean HAQ-DI was 0.7, a mean percent improvement of 31.

In Study IV, mean HAQ scores improved from baseline levels of 1.7, 1.7, and 1.8 to 1.1, 1.0, and 0.8 at 12 months in the MTX, ENBREL, and ENBREL/MTX combination treatment groups, respectively (Combination versus both MTX and ENBREL, $p < 0.01$). Twenty-nine percent of patients in the MTX alone treatment group had an improvement of HAQ of at least one unit versus 40% and 51% in the ENBREL alone and the ENBREL/MTX combination treatment groups, respectively. Further, 24% of patients in the combination treatment group who registered some disability in HAQ at baseline had improved to a HAQ of 0 (no disability) by month 12.

Radiographic Response

In Study III, structural joint damage was assessed radiographically and expressed as change in total Sharp score (TSS) and its components, the erosion score and joint space narrowing (JSN) score. Radiographs of hands/wrists and forefeet were obtained at baseline, 6 months, 12 months, and 24 months and scored by readers who were unaware of treatment group. The results are shown in Table 8. A significant difference for change in erosion score was observed at 6 months and maintained at 12 months.

Table 8. Mean Radiographic Change Over 6 and 12 Months in Study III

		MTX	25 mg ENBREL	MTX-ENBREL (95% Confidence Interval*)	P-value
12 Months	Total Sharp score	1.59	1	0.59 (-0.12, 1.30)	0.11
	Erosion score	1.03	0.47	0.56 (0.11, 1.00)	0.002
	JSN score	0.56	0.52	0.04 (-0.39, 0.46)	0.529
6 Months	Total Sharp score	1.06	0.57	0.49 (0.06, 0.91)	0.001
	Erosion score	0.68	0.3	0.38 (0.09, 0.66)	0.001
	JSN score	0.38	0.27	0.11 (-0.14, 0.35)	0.585

JSN = Joint Space Narrowing; MTX = methotrexate

*95% confidence intervals for the differences in change scores between MTX and ENBREL

Patients continued on the therapy to which they were randomized for the second year of Study III. Seventy-two percent of patients had x-rays obtained at 24 months. Compared to the MTX group, greater inhibition of progression in TSS and erosion score was seen in the 25 mg ENBREL group, and in addition, less progression was noted in the JSN score. These differences did not reach statistical significance.

In the open-label extension (fifth year of Study III), patients treated with 25 mg ENBREL had continued inhibition of structural damage. Patients originally treated with MTX had further reduction in radiographic progression once they began treatment with ENBREL.

In Study IV, significantly less radiographic progression (TSS) was observed with ENBREL in combination with MTX compared with ENBREL alone or MTX alone at month 12 (Figure 2). In the MTX treatment group 57% of patients experienced no radiographic progression (TSS change ≤ 0.5) at 12 months compared to 68% and 80% in the ENBREL alone and the ENBREL/MTX combination treatment groups, respectively. Significant regression in TSS (-0.54) was observed in the ENBREL/MTX combination treatment group at 12 months [95% CI, (-1.00 to -0.07)], indicating the inhibition of structural damage.

Figure 2. Mean Radiographic Change at 12 Months in Study IV

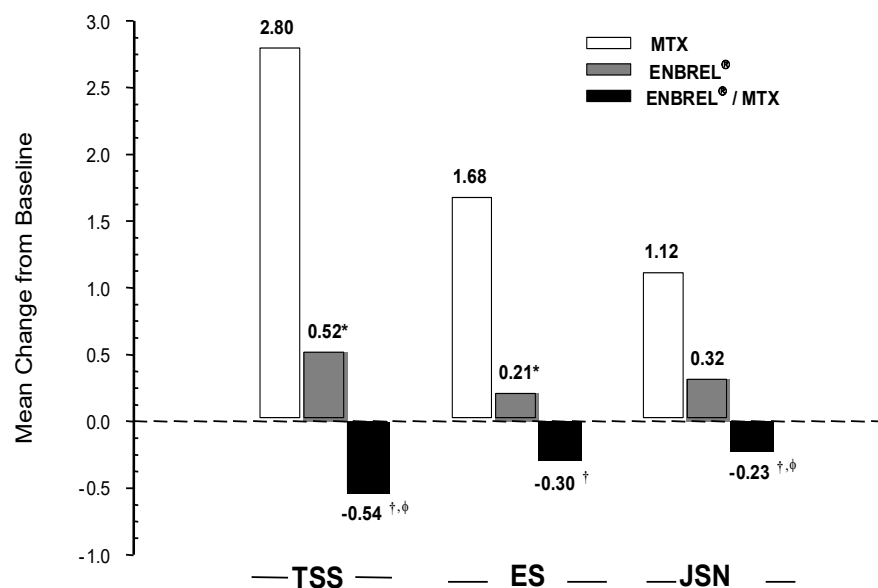

ES = Erosion score; JSN = Joint Space Narrowing; MTX = methotrexate; TSS = Total Sharp score

Pairwise comparison p-values:

* $p < 0.05$ for comparisons of ENBREL vs MTX

† $p < 0.05$ for comparisons of ENBREL/MTX vs MTX

ϕ $p < 0.05$ for comparisons of ENBREL/MTX vs ENBREL

Results in Geriatric Patients

A total of 480 geriatric (age ≥ 65 years) RA patients have been studied in clinical trials. Their clinical responses were comparable to responses seen in RA patients < 65 years of age.

Once Weekly Dosing

The safety and efficacy of 50 mg ENBREL (two 25 mg SC injections) administered once weekly were evaluated in a double-blind, placebo-controlled study of 420 patients with Active RA. In this study, 53 patients received placebo, 214 patients received 50 mg ENBREL once weekly, and 153 patients received 25 mg ENBREL twice weekly (72 to 96 hours apart). The safety and efficacy profiles of the two ENBREL treatment groups were similar.

Other Studies

An open-label, single-arm study was conducted to assess the safety and immunogenicity of etanercept manufactured by a modified process, administered weekly for up to 24 weeks in 220 RA patients who were etanercept-naïve and not receiving MTX therapy. The immunogenicity data are comparable to those observed in other studies with etanercept. Positive binding antibodies were detected in 4.5% of patients at week 12 and 0.5% at week 24. In this study, as in previous studies, no patient tested positive for neutralizing antibodies. Overall, the safety

profile (both adverse events and immunogenicity) was comparable to the etanercept manufactured using the previous process (see **ADVERSE REACTIONS, Clinical Trial Adverse Reactions**).

14.2 Polyarticular Juvenile Idiopathic Arthritis (JIA)

Study demographics and trial design

The safety and efficacy of ENBREL were assessed in a two-part study in 69 children with polyarticular JIA who had a variety of JIA onset types. Patients aged 4 to 17 years with moderately to severely active polyarticular JIA refractory to or intolerant of MTX were enrolled; patients remained on a stable dose of a single non-steroidal anti-inflammatory drug and/or prednisone (≤ 0.2 mg/kg/day or 10 mg maximum). In part 1, all patients received 0.4 mg/kg (maximum 25 mg per dose) ENBREL SC twice weekly. In part 2, patients with a clinical response at day 90 were randomized to remain on ENBREL or receive placebo for four months and assessed for disease flare. Responses were measured using the JIA Definition of Improvement (DOI), defined as a $\geq 30\%$ improvement in at least three of six and $\geq 30\%$ worsening in no more than one of six JIA core set criteria, including active joint count, limitation of motion, physician and patient/parent global assessments, functional assessment, and ESR. Disease flare was defined as a $\geq 30\%$ worsening in three of the six JIA core set criteria and $\geq 30\%$ improvement in not more than one of the six JIA core set criteria and a minimum of two active joints.

Table 9. Summary of Patient Demographics for Clinical Trials in Patients with Juvenile Idiopathic Arthritis

Study #	Trial design	Dosage, route of administration and duration	Study patients (n)	Mean age (years)	Gender (% female)
Study I (Lovell et al, 2000)	Multicenter, 2 part study in children with polyarticular JIA	Part 1: ENBREL 0.4 mg/kg (maximum 25 mg per dose) SC twice weekly for 90 days			
		Part 2: 0.4 mg/kg (maximum 25 mg per dose) or placebo SC twice weekly until disease flare or 4 months, whichever was earlier			
		ENBREL:	25	9	76
		Placebo:	26	12	58

JIA = juvenile idiopathic arthritis; SC = subcutaneous

Study Results

In part 1 of the study, 51 of 69 (74%) patients demonstrated a clinical response and entered part 2. In part 2, 7 of 25 (28%) patients remaining on ENBREL experienced a disease flare compared to 21 of 26 (81%) patients receiving placebo ($p = 0.0030$). From the start of part 2, the median time to flare was ≥ 116 days for patients who received ENBREL and 28 days for patients who received placebo. Each component of the JIA core set criteria worsened in the arm that received placebo and remained stable or improved in the arm that continued on ENBREL. The data suggested the possibility of a higher flare rate among those patients with a higher baseline ESR. Of patients who demonstrated a clinical response at 90 days and entered

part 2 of the study, some of the patients remaining on ENBREL continued to improve from month 3 through month 7, while those who received placebo did not improve.

The majority of JIA patients who developed a disease flare in part 2 and were reintroduced to ENBREL treatment up to 4 months after discontinuation re-responded to ENBREL therapy, in open-label studies. Durable response has been observed for over 4 years in JIA patients.

Studies have not been done in patients with polyarticular JIA to assess the effects of continued ENBREL therapy in patients who do not respond within 3 months of initiating ENBREL therapy, or to assess the combination of ENBREL with MTX.

14.3 Adult Psoriatic Arthritis (PsA)

Study demographics and trial design

The safety and efficacy of ENBREL were assessed in a randomized, double-blind, placebo-controlled study in 205 adult patients with PsA. Patients were between 18 and 70 years of age and had active PsA (≥ 3 swollen joints and ≥ 3 tender joints) in at least one of the following forms: (1) Distal interphalangeal (DIP) involvement; (2) polyarticular arthritis (absence of rheumatoid nodules and presence of psoriasis); (3) arthritis mutilans; (4) asymmetric PsA; or (5) spondylitis-like ankylosis. Patients also had PsO with a qualifying target lesion ≥ 2 cm in diameter. Patients currently on MTX therapy (stable for ≥ 2 months) could continue at a stable dose of ≤ 25 mg/week MTX. Doses of 25 mg ENBREL or placebo were administered SC twice a week during the initial 6-month double-blind period of the study. Patients continued to receive blinded therapy in a 6-month maintenance period until all had completed the initial 6-month controlled period. Following this, patients received open-label 25 mg ENBREL twice a week in a 48-week extension period.

Table 10. Summary of Patient Demographics for Clinical Trials in Patients with Psoriatic Arthritis

Study #	Trial design	Dosage, route of administration and duration	Study patients (n)	Mean age (years)	Gender (% female)
Study I (Mease et al, 2004)	Multicenter, randomized, double-blind, placebo-controlled study in adults with PsA	ENBREL 25 mg or placebo SC twice weekly for up to 12 months			
		ENBREL:	101	47	55
		Placebo:	104	48	43
Study I Open-Label Extension (Mease et al, 2006)	Multicenter, open label extension study in adults with PsA	ENBREL 25 mg SC twice weekly in 48-week extension period	169	47.0	49

PsA = Psoriatic Arthritis; SC = subcutaneous

In the double-blind period of the study, the proportion of patients who discontinued from study was approximately 20% (31% of placebo-treated patients and 8% of ENBREL-treated patients). The proportion of patients who discontinued due to adverse events was approximately 1% in both ENBREL and placebo groups and the proportion of patients who discontinued due to lack of efficacy was 5% in the ENBREL group and 22% in the placebo group.

In the open-label period of the study, the proportion of patients who discontinued from the study was approximately 12%. The proportion of patients who discontinued due to adverse events was approximately 2% and the proportion of patients who discontinued due to lack of efficacy was approximately 2%.

Study Results

The results were expressed as percentages of patients achieving the ACR 20, 50, and 70 response and percentages with improvement in Psoriatic Arthritis Response Criteria (PsARC). Results are summarized in Table 11.

Table 11. Responses of Patients with Psoriatic Arthritis in Placebo-Controlled Trial

<u>Psoriatic Arthritis Response</u>	Percent of Patients	
	Placebo N = 104	ENBREL ^a N = 101
<u>ACR 20</u>		
Month 1	11	38 ^b
Month 3	15	59 ^b
Month 6	13	50 ^b
<u>ACR 50</u>		
Month 1	2	11 ^c
Month 3	4	38 ^b
Month 6	4	37 ^b
<u>ACR 70</u>		
Month 1	0	1
Month 3	0	11 ^b
Month 6	1	9 ^c
<u>PsARC</u>		
Month 1	24	56 ^b
Month 3	31	72 ^b
Month 6	23	70 ^b
<u>Psoriasis Response</u>		
PASI (subset of patients ^d)	(N = 62)	(N = 66)
50% improvement		
Month 1	13	18
Month 3	15	36 ^c
Month 6	18	47 ^b
75% improvement		
Month 1	2	8
Month 3	8	12
Month 6	3	23 ^c

ACR = American College of Rheumatology response criteria PASI = psoriasis area and severity index;
PsARC = psoriatic arthritis response criteria

- a. 25 mg ENBREL subcutaneous (SC) twice weekly
- b. $p < 0.001$, ENBREL vs. placebo
- c. $p < 0.01$, ENBREL vs. placebo
- d. Patients with psoriasis involvement $\geq 3\%$ body surface area

Among adult patients with PsA who received ENBREL, clinical responses were noted at the time of the first visit at 4 weeks (25% of patients). The median time to first response was 12 weeks, and 75% of patients achieved a response by 36 weeks. Responses were maintained through the initial 6 months of therapy and the maintenance period. ENBREL was significantly better than placebo in all measures of disease activity ($p < 0.001$), and responses were similar with and without concomitant MTX therapy.

In the open-label extension period, ACR20/50/70 responses, PsARC responses, and all measures of disease activity were maintained or improved in patients who continued to receive etanercept for up to an additional 48 weeks. Similar improvements were seen for the patients who received placebo in the double-blind period of the study once they began receiving ENBREL in the open-label period. By week 48 of the open-label period, 63%, 46%, and 18% of patients achieved or maintained the ACR20, ACR50, and ACR70 response, respectively, and 82% of patients achieved the PsARC response.

In adult PsA patients, the skin lesions of psoriasis were also improved with ENBREL, relative to placebo, as measured by percentages of patients achieving improvements in the psoriasis area and severity index (PASI). In the open-label extension period of the study, target lesion clear or almost clear and PASI 50/75/90 were maintained or improved in patients who continued to receive etanercept for up to an additional 48 weeks. Similar improvements were seen for the patients who received placebo in the double-blind period of the study once they began receiving ENBREL. At week 48 of the open-label period, 55% of patients achieved or maintained a target lesion assessment of clear or almost clear. In a subset of patients with psoriasis $\geq 3\%$ BSA, 67% had achieved a PASI 50 and 38% achieved a PASI 75 by week 48 of the open-label period. Responses according to the Dermatologists Static Global Assessment of Psoriasis were also maintained through the 48-week open label period.

Radiographic Response

Radiographic progression was also assessed in adult patients with PsA. Radiographs of hands and wrists, including distal interphalangeal joints, were obtained at baseline, 6 months, 12 months, and 24 months. The results are shown in Table 12.

Table 12. Mean Radiographic Change Over 6 and 12 Months in Psoriatic Arthritis

		Placebo	25 mg ENBREL	p-value
12 months	Total Sharp score	1.00	-0.03	0.0001
	Erosion score	0.66	-0.09	<0.0001
	JSN score	0.34	0.05	0.0438
6 months	Total Sharp score	0.53	-0.03	0.0006
	Erosion score	0.33	-0.09	0.0002
	JSN score	0.20	0.06	0.2033

JSN = Joint Space Narrowing

ENBREL inhibited progression of structural damage in adult patients with PsA over a 12-month period, while measurable structural progression was observed in the placebo group. The differences between groups were observed as early as 6 months. Inhibition of radiographic progression was maintained in patients who continued on ENBREL during the second year. The mean annualized changes from baseline in the Total Sharp Score (TSS) in the continuous ENBREL group was -0.28 units at 1 year and -0.38 units at 2 years. Similar inhibition of structural progression was seen for patients who received placebo in the double-blind period once they began receiving ENBREL.

Physical Function Response

Quality of life in PsA patients was assessed at every timepoint using the physical function and disability index of the HAQ. Additionally, patients were administered the SF-36 Health Survey. Patients treated with 25 mg ENBREL twice weekly showed significantly greater improvement from baseline in the HAQ score at month 3 (mean decrease of 53.5%) and month 6 (mean decrease of 53.6%) in comparison to placebo (mean decrease of 6.3% and 6.4% at month 3 and 6, respectively) ($p < 0.001$) for the HAQ disability domain (where 0 = none and 3 = severe). At months 3 and 6, patients treated with ENBREL showed significantly greater improvement from baseline in SF-36 physical component summary score compared to patients treated with placebo, and no worsening in the SF-36 mental component summary score. Improvements in physical function and disability measures have been maintained for up to 2 years through the open-label portion of the study.

14.4 Ankylosing Spondylitis (AS)

Study demographics and trial design

The safety and efficacy of ENBREL were assessed in a randomized, double-blind, placebo-controlled study in 277 patients with AS. Patients were between 18 and 70 years of age and had active AS as defined by the modified New York Criteria for Ankylosing Spondylitis. Patients taking hydroxychloroquine, sulfasalazine, or methotrexate (stable for 4 weeks prior to study start) could continue these drugs at stable doses for the duration of the study. Doses of 25 mg ENBREL or placebo were administered SC twice a week for 6 months. Patients who participated in this double-blind study were eligible to enter into an open-label follow-up study where all patients received 25 mg SC twice weekly or 50 mg once weekly for up to 42 months.

Table 13. Summary of Patient Demographics for Clinical Trials in Patients with Ankylosing Spondylitis

Study #	Trial design	Dosage, route of administration and duration	Study patients (n)	Mean age (years)	Gender (% male)
Study I (Davis et al, 2003)	Multicenter, randomized, double-blind, placebo-controlled study in patients with AS	ENBREL 25 mg or placebo SC twice weekly for 6 months			
		ENBREL:	138	42	76
		Placebo:	139	42	76

AS = ankylosing spondylitis; SC = subcutaneous

Study Results

The primary measure of efficacy was a 20% improvement in the Assessment in Ankylosing Spondylitis (ASAS) response criteria. Compared to placebo, treatment with ENBREL resulted in significant improvements in the ASAS and other measures of disease activity in patients with AS (Figure 3 and Table 14).

At 12 weeks, the ASAS 20/50/70 responses were achieved by 60%, 45%, and 29%, respectively, of patients receiving ENBREL, compared to 27%, 13%, and 7%, respectively, of patients receiving placebo ($p \leq 0.0001$, ENBREL vs. placebo). Similar responses were seen at week 24.

Figure 3. ASAS Responses in Ankylosing Spondylitis

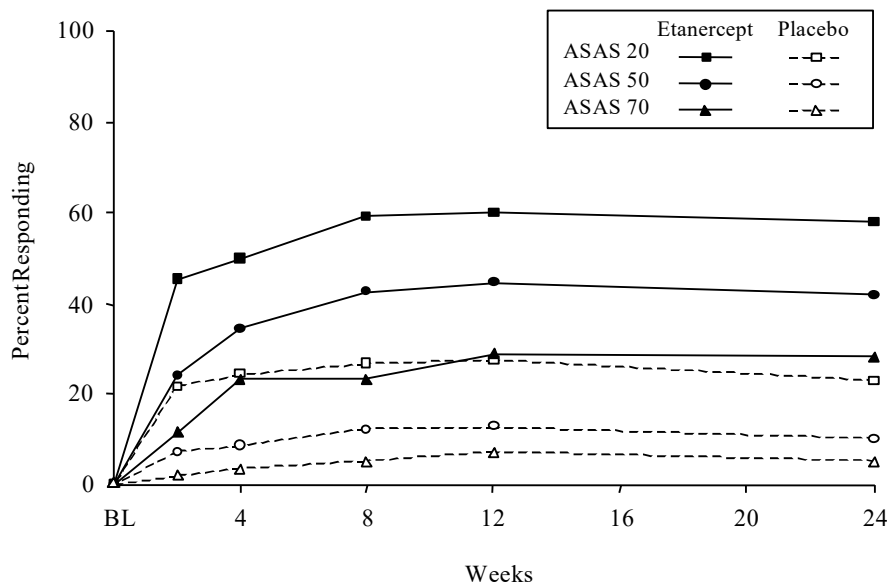

Table 14. Measures of Disease Activity in Ankylosing Spondylitis

Mean values at time points	Placebo N = 139		Placebo/ ENBREL Open-label Extension N = 129	ENBREL ^a N = 138		ENBREL Open-label Extension N = 128
	Baseline	6 Months	4 Years	Baseline	6 Months	4 Years
ASAS response criteria						
Patient global assessment ^b	62.9	56.3	25.9	62.9	36.0	19.7
Nocturnal and back pain ^c	62.1	56.2	24.1	59.8	34.0	18.8
BASFI ^d	56.3	54.7	31.1	51.7	36.0	22.7
Inflammation ^e	64.3	56.6	26.0	61.4	33.4	19.0
Acute phase reactants						
CRP (mg/dL) ^f	2.0	1.9	0.5	1.9	0.6	0.3
ESR (mm/hr) ^g	25.4	25.9	-	25.9	11.2	-
Spinal mobility (cm):						
Modified Schober's test	2.97	2.88	3.0	3.06	3.34	3.5
Chest expansion	3.21	3.01	3.7	3.26	3.85	4.1
Occiput-to-wall measurement	5.33	6.01	5.4	5.59	4.53	3.6

^a p < 0.0015 for all comparisons between ENBREL and placebo at 6 months. P-values for continuous endpoints were based on percent change from baseline.

^b Measured on a VAS scale with 0 = "none" and 100 = "severe."

^c Average of total nocturnal and back pain scores, measured on a VAS scale with 0 = "no pain" and 100 = "most severe pain."

^d Bath Ankylosing Spondylitis Functional Index (BASFI), average of 10 questions.

^e Inflammation represented by the average of the last 2 questions on the 6-question Bath Ankylosing Spondylitis Disease Activity Index (BASDAI).

^f C-reactive protein (CRP) normal range: 0 – 1.0 mg/dL.

^g Erythrocyte sedimentation rate (ESR) normal range: 1–17 mm/hr for men; 1–25 mm/hr for women.

Among patients with AS who received ENBREL, the clinical responses were apparent as early as 2 weeks, reach maximum within the first 2 months on study, and were maintained through 6 months of therapy. Responses were similar in patients who were not receiving concomitant therapies at baseline. The results of this study were similar to those seen in an earlier single-center, randomized, placebo-controlled study of 40 patients with AS and a multi-center, randomized, placebo-controlled study of 84 patients with AS.

Regardless of treatment group in the initial double-blind study, ASAS 20/50/70, BASDAI, and BASFI responses were maintained or improved in patients treated with ENBREL during a 42-month open-label extension study. Although patient-reported outcomes were not collected

during the controlled period of the study, patients who had received placebo in controlled period showed rapid improvement in patient-reported outcomes (SF-36 and EQ-5D) with ENBREL treatment by week 12 of the open-label study. Improvement in patient-reported outcomes was sustained over 4 years in both the previous placebo and ENBREL groups.

14.5 Adult Plaque Psoriasis (PsO)

Study demographics and trial design

The safety and efficacy of ENBREL were assessed in three randomized, double-blind, placebo-controlled studies in adults with chronic stable PsO involving $\geq 10\%$ of the body surface area, a minimum PASI of 10. Patients with guttate, erythrodermic, or pustular psoriasis and patients with severe infections within 4 weeks of screening were excluded from study. No concomitant major anti-psoriatic therapies were allowed during the study. Long-term, open label phases of these three studies were also conducted.

Table 15. Summary of Patient Demographics for Clinical Trials in Patients with Plaque Psoriasis

Study #	Trial design	Dosage, route of administration and duration	Study patients (n)	Mean age (years)	Gender (% female)
Study I (Leonardi et al, 2003)	Multicenter, double-blind, randomized placebo-controlled study	ENBREL 25 mg, SC once a week or twice a week; 50 mg, SC twice weekly for 6 months; placebo			
		ENBREL 25 mg QW:	160	46	26
		ENBREL 25 mg BIW:	162	44	33
		ENBREL 50 mg BIW:	164	45	35
		Placebo:	166	45	37
Study II (Papp et al, 2005)	Multicenter, double-blind, randomized placebo-controlled study	ENBREL 25 mg, 50 mg, or placebo; SC twice weekly for 3 months			
		ENBREL 25 mg BIW:	196	45	35
		ENBREL 50 mg BIW:	194	45	33
		Placebo:	193	45	36
Study III (Tyring et al, 2007)	Multicenter, double-blind, randomized placebo-controlled study	ENBREL 50 mg, or placebo; SC twice weekly for 12 weeks.			
		ENBREL 50 mg BIW:	311	46	35
		Placebo:	307	46	30

BIW = twice weekly; QW = once weekly; SC = subcutaneous

Study I evaluated 652 patients who received ENBREL SC at doses of 25 mg SC once a week, 25 mg SC twice a week or 50 mg twice a week for 6 consecutive months. During the first 12 weeks of the double-blind treatment period, patients received placebo or one of the above three ENBREL doses. After 12 weeks of treatment, patients in the placebo group began treatment with blinded ENBREL (25 mg twice a week); patients in the active treatment groups continued to week 24 on the dose to which they were originally randomized. Patients who achieved PASI

improvement of at least 50% at week 24 were discontinued from treatment and observed until relapse during the study drug withdrawal period. Relapse was defined as a loss of at least half of the improvement achieved between baseline and week 24. Upon relapse, patients were retreated with ENBREL in a blinded fashion at the dose they had been receiving at week 24.

Study II evaluated 583 patients who received placebo or ENBREL SC at doses of 25 mg or 50 mg twice a week for 3 months. After 3 months of randomized blinded treatment, patients in all three arms began receiving open-label ENBREL at 25 mg twice weekly for up to 9 additional months.

Study III evaluated 618 patients who received placebo or ENBREL SC at a dose of 50 mg twice weekly in a blinded fashion for 12 weeks. After 12 weeks patients in both arms of the study received 50 mg twice weekly in an open-label extension phase for a further 84 weeks (through week 96 open-label period part 1). Beginning at week 97, eligible patients entered open-label period part 2, during which time their dosage was decreased to ENBREL 50 mg once weekly. At week 120 or 132, eligible patients who did not maintain protocol-defined clinical efficacy at 50 mg once weekly had the option to dose escalate to ENBREL 50 mg twice weekly for the remainder of the study (through week 144).

Clinical Response

The percent of ENBREL-treated patients achieving at least a 50%, 75%, or 90% improvement in PASI (PASI 50, 75, and 90 responses, respectively) showed a dose response relationship between doses of 25 mg once a week, 25 mg twice a week and 50 mg twice a week. This dose response was also observed as measured by the Physician Static Global Assessment for clear or almost clear status, and mean percent improvement in PASI. In Studies I, II, and III the primary endpoint was the PASI 75 response at week 12. In Studies I and II, PASI 75 was seen in 3, 14, 34, and 49 percent of patients for placebo, 25 mg once weekly, 25 mg twice weekly and 50 mg twice weekly groups, respectively. In Study I, continued improvement was seen through week 24 in Study I for all doses (Figure 4).

Figure 4. Percent of Patients Achieving a PASI 75 Response in Double-blind and Retreatment Periods of Study I

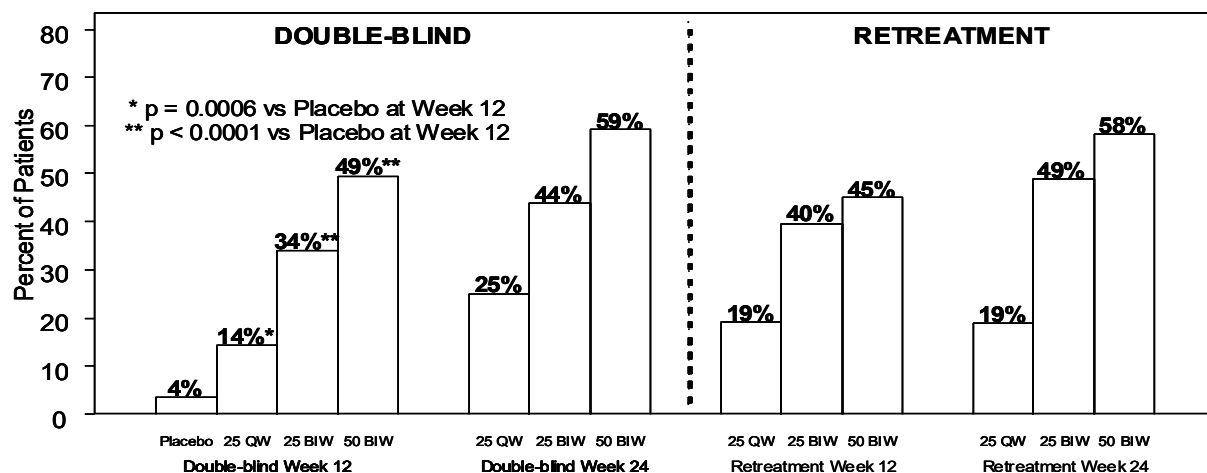

In Study II, maintenance of PASI 75 response was seen between weeks 12 and 24 in patients dosed at 25 mg twice a week who were originally dosed at 50 mg twice a week (Figure 5). PASI 50, 75, 90, mean percent improvement in PASI and Dermatology Life Quality Index (DLQI) responses were maintained in the open-label period for up to 12 months.

Figure 5. Percent of Patients Achieving a PASI 75 Response Over Time in Study II

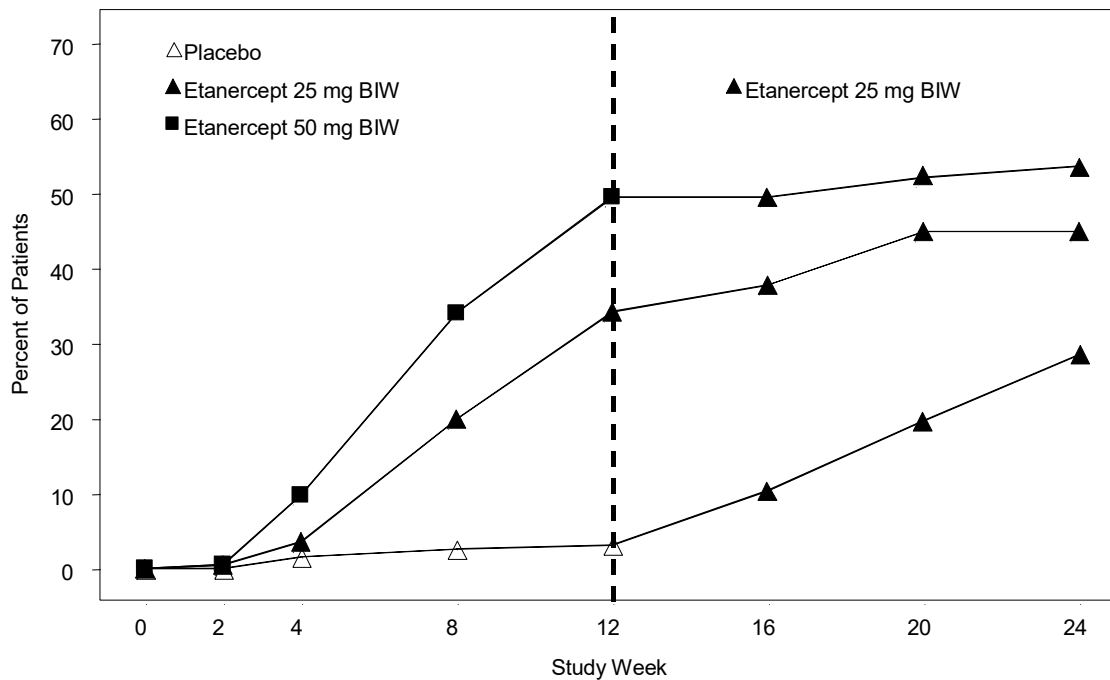

In Study III, PASI 75 was seen in 5 and 47 percent of patients at week 12 for placebo and 50 mg twice weekly groups, respectively.

The mean percent improvement in PASI, and Physician Static Global Assessment were significantly improved compared to placebo by week 2 at doses of 25 mg twice a week and 50 mg twice a week. In Studies I and II combined, 11% and 21% of patients at doses of 25 mg twice a week and 50 mg twice a week, respectively, achieved a high degree of clearing at week 12 as indicated by PASI 90 response. Additionally, continued improvement in PASI 90 was seen through week 24 in Study I, which was achieved by 20% and 30% of patients at doses of 25 mg twice a week and 50 mg twice a week, respectively. In Study III, PASI 90 was achieved at week 96 by 23% of patients at doses of ENBREL 50 mg twice weekly. Results from patients receiving placebo or 25 mg or 50 mg twice weekly ENBREL from the three studies are summarized in Table 16.

Table 16. Outcomes in Studies I, II and III

Response	Study I					Study II			Study III			
	Placebo	ENBREL			Placebo	ENBREL		Placebo	ENBREL			
		25 mg BIW ^a	50 mg BIW	50 mg BIW		25 mg BIW ^a	50 mg BIW		50 mg BIW	Placebo / 50mg BIW	50 mg BIW / 50 mg BIW	
N = 166 week 12	N = 162 week 12	N = 162 week 24	N = 164 week 12	N = 164 week 24	N = 193 week 12	N = 196 week 12	N = 194 week 12	N = 307 week 12	N = 311 week 12	N = 306 week 96	N = 311 week 96	
PASI 50 - %	14	58**	70	74**	77	9	64**	77**	14	74**	79	83
PASI 75 - %	4	34**	44	49**	59	3	34**	49**	5	47**	52	51
PASI 90 - %	1	12**	20	22**	30	1	11**	21**	1	21**	23	23
Physician static global assessment, clear or almost clear - % (0 or 1 on 0-5 scale)	5	34**	39	49**	55	4	39**	57**	6	49**	39	41
Percent improvement from baseline in PASI - mean	14.0	52.6**	62.1	64.2**	71.1	0.2	56.8**	67.5**	6.9	63.2**	67.5	69.8
Percent improvement from baseline in DLQI - mean	10.9	50.8**	59.4	61.0**	73.8	6.2	65.4**	70.2**	22.1	69.1**	68.3	67.3
Patients static global assessment of psoriasis - median (0-5 scale)	4.0	2.0**	2.0	1.5**	1.0	4.0	2.0**	1.0**	4.0	1.0	1.0	1.0

BIW = twice a week; DLQI = dermatology life quality index; PASI = psoriasis area and severity index

** p ≤ 0.0001 compared with placebo at week 12.

^a 25 mg administered twice weekly has been shown to have comparable exposure and efficacy to 50 mg administered once weekly.

In Study III during weeks 13 through 96, of the open-label period ENBREL therapy continued to provide clinically meaningful improvements to both patient groups. After initiation of ENBREL therapy at week 13, patients who had received placebo through week 12 (placebo/ENBREL group) showed improvements similar to those seen in the patients who had received etanercept weeks 1 through 12 in the double-blind portion of the study (ENBREL/ ENBREL group).

Patient reported outcomes also improved in patients receiving ENBREL in Studies I, II and III. Patients receiving each dose of ENBREL demonstrated significant improvements at week 12 in the DLQI and all six subscales including symptoms and feelings, daily activities, leisure, work and school, personal relationships, and treatment. After 12 weeks of treatment, a greater proportion of patients on ENBREL reported a total DLQI score of 0, indicating that these patients were “not at all” affected by their psoriasis for all six subscales of the DLQI. For Studies I and II, respectively, 24% and 25% for 50 mg twice a week, 12% and 20% for 25 mg twice a week versus 2% and 1% for placebo). For Study III at 12 weeks, the portion of patients with a total DLQI score of 0 was 28% and 43%, for ENBREL 50 mg twice weekly and placebo, respectively.

The Patient Static Global Assessment and the mean percent improvement in DLQI was significantly improved compared to placebo by week 2 at doses of 25 mg twice a week and 50 mg twice a week. In addition, the two summary scales of the SF-36 Health Survey obtained in Study II, the physical component summary and the mental component summary, significantly improved at week 12 in patients treated with 25 mg or 50 mg twice a week.

In Study I, 409 patients who achieved PASI improvement of at least 50% at week 24 were entered into a study drug withdrawal and retreatment period as described above. During the study drug withdrawal period, patients had a median time to disease relapse of 3 months. Responses to retreatment with ENBREL at weeks 12 and 24 were similar in magnitude to those seen during the initial double-blind portion of the study (Figure 4).

In Study II, 190 patients initially randomized to 50 mg twice a week had their ENBREL dose decreased at week 12 from 50 mg twice a week to 25 mg twice a week for an additional 3 months. Of the 91 patients who were PASI 75 responders at week 12, 77% maintained their PASI 75 response at week 24. Of the 23% who were PASI 75 nonresponders at week 24, 20% were PASI 50 responders and 3% were PASI 50 nonresponders. Additionally, of the 88 patients who were PASI 75 nonresponders at week 12, 32% became PASI 75 responders at week 24.

14.6 Pediatric Plaque Psoriasis (PsO)

Study demographics and trial design

The safety and efficacy of ENBREL were assessed in a 48-week, randomized, double-blind, placebo-controlled study in 211 pediatric patients with moderate to severe PsO. Patients enrolled in the study were aged 4 to 17 years with moderate to severe PsO (as defined by a Static Physician’s Global Assessment (sPGA) score ≥ 3 , involving $\geq 10\%$ of the body surface area, and a PASI score ≥ 12) and had a history of receiving phototherapy or systemic therapy, or were inadequately controlled on topical therapy. Patients with guttate, erythrodermic, or pustular psoriasis and patients with severe infections within 4 weeks of screening were excluded. The study consisted of three treatment periods: a 12-week, double-blind, placebo-controlled treatment period; a 24-week, open-label treatment period; and a 12-week, randomized double-blind, withdrawal-retreatment period. In the first treatment period, subjects were stratified into two age groups at randomization (4 to 11 years old versus 12 to 17 years old).

Table 17. Summary of Patient Demographics for a Clinical Trial in Pediatric Patients with Plaque Psoriasis

Study #	Trial design	Dosage, route of administration and duration	Study patients (n)	Mean age (Range)	Gender % female (n)
Study 1 (Paller et al.)	Part 1: Multicenter, double-blind, randomized, placebo-controlled	ENBREL 0.8 mg/kg (up to a maximum of 50 mg per dose) or placebo SC once weekly for 12 weeks	ENBREL: 106	12.8 (4-17)	48% (51)
			Placebo: 105	12.6 (4-17)	50% (52)
	Part 2: Multicentre, open-label	ENBREL open-label 0.8 mg/kg (up to a maximum of 50 mg per dose) SC once weekly for 24 weeks	208	12.7 (4-17)	49% (102)
Part 3: Multicenter, double-blind, randomized, withdrawal-retreatment	12-week withdrawal retreatment period; ENBREL 0.8 mg/kg (up to a maximum of 50 mg per dose) or placebo SC once weekly	138	12.7 (4-17)	51% (70)	

SC = subcutaneous

Patients received ENBREL 0.8 mg/kg (up to a maximum of 50 mg per dose) or placebo once weekly for the first 12 weeks. At or after week 4 of the 12-week, double-blind, placebo-controlled treatment period, subjects whose psoriasis worsened relative to baseline (> 50% increase in PASI score, and an absolute increase of at least 4 points compared to baseline) were allowed to enter an escape arm to receive open-label ENBREL every week through week 12. After 12 weeks, the patients entered a 24-week open-label treatment period in which all patients received ENBREL at the same dose. This was followed by a 12-week withdrawal retreatment period.

Response to treatment was assessed after 12 weeks of therapy and was defined as the proportion of patients who achieved a reduction in PASI score of at least 75% from baseline. The PASI is a composite score that takes to consideration both the fraction of body surface area affected and the nature and severity of psoriasis changes within the affected regions (induration, erythema, and scaling).

Other evaluated outcomes included the proportion of patients who achieved a score of “clear” or “almost clear” by the sPGA and the proportion of patients with a reduction in PASI score of at least 50% and 90% from baseline. The sPGA is a 6-category scale ranging from “5 = severe” to “0 = none” indicating the physician’s overall assessment of the PsO severity focusing on induration, erythema and scaling. Treatment success of “clear” or “almost clear” consisted of none or minimal elevation in plaque, up to faint red colouration in erythema and none or minimal fine scale over <5% of the plaque. Patients who entered the escape arm or who had missing data at week 12 were considered treatment failures. Treatment failures were considered non-

responders for PASI 75, PASI 50 and PASI 90 responses and the clear/almost clear status of sPGA.

Patients in all treatment groups had a median baseline PASI score of 16.4, and the percentage of patients with baseline sPGA classifications was 65% for moderate, 31% for marked and 3% for severe. Across all treatment groups, the percentage of patients who previously received systemic or phototherapy for PsO was 57%.

Efficacy results are summarised in Table 18.

Table 18. Pediatric Psoriasis Outcomes at 12 Weeks

	Placebo (N = 105)	ENBREL 0.8 mg/kg Once Weekly (N = 106)
PASI 75, n (%)	12 (11%)	60 (57%) ^a
PASI 50, n (%)	24 (23%)	79 (75%) ^a
sPGA “clear” or “almost clear”, n (%)	14 (13%)	56 (53%) ^a
PASI 90, n (%)	7 (7%)	29 (27%) ^a

PASI = psoriasis area and severity index; sPGA = static physician’s global assessment

^a p < 0.0001 compared with placebo

p-value is based on two-sided Cochran-Mantel-Haenszel test stratified by age group (4 to 11 years old versus 12 to 17 years old).

Overall significance level for primary and secondary endpoints at week 12 is controlled at 0.05 using a sequential testing scheme.

Maintenance of Response

To evaluate maintenance of response, subjects who achieved PASI 75 response at Week 36 were re-randomized to either ENBREL or placebo during a 12-week randomized withdrawal period. The maintenance of PASI 75 response was evaluated at Week 48. The proportion of patients who maintained PASI 75 response at Week 48 was numerically higher for subjects treated with ENBREL (64%) compared to those treated with placebo (49%).

15 MICROBIOLOGY

No microbiological information is required for this drug product.

16 NON-CLINICAL TOXICOLOGY

The preclinical toxicologic profile of TNFR:Fc was evaluated in monkeys, rats, mice and rabbits. Multidose toxicity studies were conducted in monkeys following repeat administration by intravenous, subcutaneous or oronasal inhalation routes. The incidence and time course of neutralizing antibody formation were characterized in toxicity and reproductive toxicity studies, as well as in special toxicology studies in mice, rats and rabbits.

TNFR:Fc was well tolerated in all species used in preclinical toxicology studies at doses representing large multiples (up to 30x in monkeys, and up to 100x in rats and rabbits) of the maximum human therapeutic dose of 0.5 mg/kg. These doses resulted in systemic exposure levels (based on AUC) that were up to about 30, 45 and 74 times higher than human exposure at the maximum therapeutic dose, in monkeys, rats, and rabbits, respectively.

Multidose Toxicity

No adverse effects were observed in monkeys administered twice-weekly subcutaneous injections of TNFR:Fc at 1, 5 and 15 mg/kg for 28 days. The only potentially treatment-related change was increased adrenal gland weights in female monkeys for the 5 and 15 mg/kg doses (34% and 54% increase in weight, respectively, compared to control). This finding was not considered of toxicologic importance, as adrenal weights for females at 5 and 15 mg/kg were within the facility's historical control range for untreated females. In addition, no macroscopic or microscopic pathologic changes occurred in adrenals, there were no clinical pathologic changes indicative of adrenal function effects, and no changes in adrenal weights were present in males at any dose. Adrenal weights for females receiving a dose of 1 mg/kg were comparable to vehicle control values. C_{max} and AUC increased with increasing dose on Days 1 and 22. These increases were dose proportional on Day 1. AUC_{0-24} at 15 mg/kg on Day 22 was approximately 30 times the anticipated human exposure. Systemic exposure in Cynomolgus monkeys at 1 and 5 mg/kg was reduced at Day 22 compared to Day 1 values. The decrease in C_{max} and AUC at 1 and 5 mg/kg is attributed to the formation of polyclonal anti-TNFR:Fc antibodies, which interfere with the quantitative ELISA method used for measurement of TNFR:Fc concentrations and increased antibody-mediated clearance. It is possible that at the higher dose of 15 mg/kg, the antibody response may be saturated or suppressed by the higher levels of TNFR:Fc.

No adverse effects have been reported through Week 14 of an ongoing 26 week study in which monkeys are administered TNFR:Fc by twice-weekly subcutaneous injection at 1, 5 and 15 mg/kg.

No treatment-related effects were observed in monkeys after two weeks of twice-weekly subcutaneous injections of either of two lots of TNFR:Fc produced at two different manufacturing facilities and production scales at 15 mg/kg. There were no toxicokinetic differences and no neutralizing antibodies were detected in monkeys following administration of either lot.

No treatment-related effects occurred in monkeys administered TNFR:Fc at 0.2 or 2.0 mg/kg subcutaneously daily for 20 days. No delayed toxicity was observed in monkeys retained for 14 days following cessation of treatment.

No treatment-related effects occurred in monkeys administered intravenous TNFR:Fc at 1.5 or 15 mg/kg as a single dose, or daily for 3 consecutive days. No delayed toxicity occurred in monkeys retained for 18 days following cessation of treatment.

Injection site reactions were minimal with repeated administration of TNFR:Fc by intravenous or subcutaneous injection.

The only treatment-related effects in monkeys administered 0.15 and 0.70 mg/kg/day TNFR:Fc via daily inhalation for 28 days were specific to this route of administration. Increased lung weight and microscopic perivascular cell infiltration and intra-alveolar histiocytosis were present in lungs at both dose levels. Minor increases in the number of granulocytic cells and myeloid erythroid (M:E) ratio were observed in bone marrow in one female monkey each in both TNFR:Fc-treated groups compared to the control group.

Special Toxicity

Neutralizing antibodies were detected in mice, rats, rabbits and Cynomolgus monkeys after multiple doses of TNFR:Fc administered by intravenous, subcutaneous or oronasal routes. In general, the incidence of both anti-TNFR:Fc and neutralizing antibodies increased with time. Anti-TNFR:Fc antibodies were detected in monkeys after 15 days of twice weekly subcutaneous administration, and were present in almost all animals by 3 to 4 weeks. In monkeys receiving daily subcutaneous injections of TNFR:Fc for 20 days, anti-TNFR:Fc antibodies continued to circulate for at least 14 days after drug administration was discontinued.

Neutralizing antibodies were detected as early as 1 week after the initiation of twice weekly subcutaneous administration of 1 mg/kg TNFR:Fc in mice and rats, and by 10 days in rabbits. After 4 weeks of twice weekly subcutaneous TNFR:Fc, neutralizing antibodies were detected in almost all mice, rats or rabbits administered 1 or 25 mg/kg TNFR:Fc. No neutralizing antibodies were detected in reproductive studies in rats following TNFR:Fc administration to pregnant rats by daily injections at 5 to 50 mg/kg for 12 days or at 3 to 30 mg/kg for up to 15 days. Neutralizing antibodies were detected in pregnant rabbits after 15 days of subcutaneous dosing at 5, 15 and 50 mg/kg. The incidence of neutralizing antibodies was lower and the time to appearance longer in monkeys than in other species.

Following twice weekly subcutaneous TNFR:Fc administration to monkeys, neutralizing antibodies were detected in 1 of 6 monkeys treated with 1 mg/kg TNFR:Fc on Day 26. No neutralizing antibodies were detectable by Day 26 in monkeys administered TNFR:Fc subcutaneously, twice weekly, at 5 or 15 mg/kg. These data support the selection of the monkey as the species of choice in multiple-dose toxicity studies.

The incidence of anti-TNFR:Fc antibodies and neutralizing antibodies appeared to be lower at higher doses of TNFR:Fc. One explanation for this observation is that the antibody ELISA can only detect free anti-TNFR:Fc antibodies ie, those not bound to TNFR:Fc in the serum sample. Only a low antibody incidence will be detected even in the presence of high levels of circulating anti-TNFR:Fc antibodies, if those antibodies are bound to TNFR:Fc. An alternate explanation is that high levels of TNFR:Fc may saturate or suppress the antibody response.

The detection of neutralizing antibodies is also compromised in the presence of circulating antibody-TNFR:Fc complexes. A serum concentration of 100 ng/mL TNFR:Fc is sufficient to negate antibody detection by the neutralizing antibody assays. Neutralizing antibodies were detected in monkeys administered TNFR:Fc via inhalation. The lower TNFR:Fc serum concentrations (< 60 ng/mL) observed in this study, compared to other monkey studies, would not interfere with the detection of neutralizing antibodies.

Reproductive Toxicity

There were no adverse effects of TNFR:Fc on pregnant rats or rabbits or their offspring following daily subcutaneous administration during the period of organogenesis at doses up to 100 times the intended clinical dose. These doses resulted in systemic exposures up to approximately 45 to 74 fold higher in rats and rabbits than human exposure at the maximum therapeutic dose, based on AUC. The rat or rabbit AUC₀₋₂₄ values were multiplied by 3 to compare daily dosing in rats or rabbits to dosing every 3 days in humans in determining these exposure ratios (rat or rabbit AUC/human AUC).

The pharmacokinetic profile of TNFR:Fc in pregnant animals was similar to that observed in non-pregnant rats and monkeys.

Neutralizing antibodies were detected in the rabbits, but not in the rat, following daily subcutaneous administration of TNFR:Fc during the period of organogenesis.

Mutagenicity

TNFR:Fc is not considered to represent a genotoxic hazard to humans based on the results of bacterial mutagenicity, mouse lymphoma cell mutagenicity, human chromosomal aberrations, and mouse micronucleus assays.

READ THIS FOR SAFE AND EFFECTIVE USE OF YOUR MEDICINE

PATIENT MEDICATION INFORMATION

^{Pr}Enbrel[®]

etanercept injection

Single-use Prefilled Syringe

Read this carefully before you start taking **ENBREL** and each time you get a refill. This leaflet is a summary and will not tell you everything about this drug. Talk to your healthcare professional about your medical condition and treatment and ask if there is any new information about **ENBREL**.

Serious Warnings and Precautions

- **Serious infections.** There have been cases where patients taking ENBREL or other TNF-blocking agents have developed serious infections, including tuberculosis (TB) and infections caused by bacteria, viruses or fungi that have spread throughout their body. Some patients have died from these infections. In very rare cases, hepatitis B recurred in patients with previous hepatitis. If you tend to get infections easily or if you develop an infection while taking ENBREL, you should tell your doctor right away.
- **Malignancies.** There have been cases, sometimes fatal, of unusual cancers in children and teenage patients who started using TNF-blocking agents, including ENBREL, at less than 18 years of age.

What is ENBREL used for?

ENBREL is a medicine for treating people with moderate to severe forms of rheumatoid arthritis (RA), juvenile idiopathic arthritis (JIA) and a type of disease called psoriatic (sore-ee-ah-tick) arthritis (PsA). ENBREL is also for treating adults with a type of arthritis called ankylosing spondylitis (ank-e-low-sing spond-e-lie-tis) (AS). ENBREL is also for adults with moderate to severe psoriasis (sore-l-ah-sis) (PsO) and children with severe psoriasis (PsO). RA, JIA, PsA and AS are inflammatory diseases that affect the joints in your body. PsO is an inflammatory disease that affects the skin and can cause raised, thick, red and scaly patches (“psoriatic skin lesions”) that can appear anywhere on the body. PsA is usually seen in patients with PsO and affects both the joints and the skin.

How does ENBREL work?

ENBREL is a type of protein called a tumour necrosis factor (TNF) blocker that blocks the action of a substance your body makes called TNF-alpha. TNF-alpha is made by your body’s immune system. People with immune diseases like RA, JIA, PsA and PsO, as well as patients with AS, have too much TNF-alpha in their bodies, which can cause inflammation and lead to painful, swollen joints and raised thick, red, scaly patches (“psoriatic skin lesions”) that can appear anywhere on the body. ENBREL can reduce the amount of TNF in the body to normal levels, helping to treat joint damage and skin lesions. In patients with inflammatory arthritis, ENBREL may be effective in reducing signs and symptoms of inflammatory arthritis (such as pain, morning stiffness and fatigue), may help improve your ability to do simple daily activities (such as dressing, walking and climbing stairs), and may help prevent damage to your bones and joints. In patients with psoriatic skin conditions, ENBREL may be effective in clearing skin and improving quality of life (such as personal relationships, work and daily activities, and treatment satisfaction).

When can I expect to see results from taking ENBREL?

Improvement may be seen as early as 1 week after starting ENBREL in adults, and within 2 weeks in children with JIA and 4 weeks with PsO. In clinical trials, full effect was usually seen by 3 months in both adults and children and was sustained with continued treatment.

In clinical trials with PsA, one quarter of patients saw improvement in their joint symptoms within 1 month, one half of patients saw improvement within 3 months, and three quarters of patients saw improvement within 9 months of treatment with ENBREL.

During the PsA clinical trials, approximately 2% of patients treated with ENBREL stopped taking ENBREL due to side effects and up to 5% of ENBREL-treated patients stopped taking ENBREL due to lack of improvement.

What are the ingredients in ENBREL?

Medicinal ingredients: etanercept

Non-medicinal ingredients: L-arginine hydrochloride, sodium chloride, sucrose, and Water for Injection, USP.

ENBREL comes in the following dosage forms:

Single-use prefilled syringes are available in 25 mg* (0.51 mL of a 50 mg/mL solution of etanercept, minimum deliverable volume of 0.47 mL) and 50 mg (0.98 mL of a 50 mg/mL solution of etanercept, minimum deliverable volume of 0.94 mL) dosage strengths.

Single-use prefilled SureClick® autoinjectors are available in a 50 mg (0.98 mL of a 50 mg/mL of etanercept, minimum deliverable volume of 0.94 mL) dosage strength.

Multiple-use vial: ENBREL is also available as a lyophilized powder in a multiple-use vial containing 25 mg etanercept per vial.

Do not use ENBREL if you:

- have ever had an allergic reaction to ENBREL or any of the ingredients in ENBREL.

The needle cover on the prefilled syringe is composed of dry natural rubber, which is made from latex. If you know you are allergic to latex, talk to your healthcare provider before using ENBREL in the prefilled syringe.

- have an infection that has spread through your body (sepsis).

To help avoid side effects and ensure proper use, talk to your healthcare professional before you take ENBREL. Talk about any health conditions or problems you may have, including if you:

- have an infection. This could put you at risk for serious side effects from ENBREL.
- have symptoms of an infection such as fever, sweats or chills, cough or flu-like symptoms, shortness of breath, blood in your phlegm, weight loss, muscle aches, warm, red, or painful areas on your skin, sores on your body, diarrhea or stomach pain, burning when you urinate or urinate more often than normal, and feel very tired.
- have a history of infections that keep coming back or other conditions — like diabetes, HIV, or a weak immune system — that might increase your risk of infections.

* 25 mg single-use prefilled syringe is not available in Canada.

- have tuberculosis (TB), or have been in close contact with someone who has or has had TB. You will need to be evaluated for TB. Your doctor should test you for TB before starting ENBREL.
- were born in, lived in, or traveled to countries where there is a risk for getting TB. Ask your doctor if you are not sure.
- live in, have lived in or have traveled to, areas where there is a greater risk for certain kinds of fungal infections (histoplasmosis, coccidioidomycosis, blastomycosis). These infections may develop or become more severe if you take ENBREL. If you don't know if you have lived in an area where these infections are common, ask your doctor.
- have or have had hepatitis B.
- have or have had persistent numbness, tingling and muscle weakness or a disease such as multiple sclerosis, Guillain-Barré or a Guillain-Barré-like syndrome, which causes inflammation of the nervous system, either in the brain and spinal cord or nerves going to your hands and feet.
- have been newly diagnosed or are being treated for congestive heart failure.
- are scheduled to have major surgery.
- have recently received or are scheduled to receive a vaccine. All vaccines should be brought up-to-date before starting ENBREL. Patients taking ENBREL should not receive live vaccines.
- use the medication Kineret® (anakinra), Orencia® (abatacept) or cyclophosphamide (see The following may interact with ENBREL below).
- have been around someone with varicella zoster (chicken pox, shingles).

Know the medicines you take. Keep a list of them to show your doctor and pharmacist each time you get a new medicine.

Your doctor should monitor you closely for signs and symptoms of TB during treatment with ENBREL even if you have tested negative for TB. If you develop any of the symptoms of TB (a dry cough that doesn't go away, weight loss, fever, night sweats) call your doctor.

If you are not sure or have any questions about any of this information, ask your doctor.

Other warnings you should know about:

All medicines have side effects. Medicines, like ENBREL, that affect your immune system can cause serious side effects. The possible serious side effects include:

- **Nervous system diseases.** There have been rare cases of disorders that affect the nervous system of people taking ENBREL or other TNF-blockers, such as multiple sclerosis, seizures or inflammation of the nerves of the eyes. Signs that you could be experiencing a problem affecting your nervous system include: numbness or tingling throughout your body, problems with your vision, weakness in your arms and/or legs, and dizziness.
- **Blood problems.** In some patients the body may fail to produce enough of the blood cells that can help your body fight infections or help you to stop bleeding. This can lead to death. If you develop a fever that doesn't go away, bruise or bleed very easily or look very pale or feel faint, call your doctor right away. Your doctor may decide to stop treatment. Some people have also had symptoms that resemble lupus (rash on your face and arms that gets worse in the sun) that may go away when you stop taking ENBREL.

- **Heart problems.** You should also tell your doctor if you have ever been treated for heart failure. If you have, your doctor may choose not to start you on ENBREL, or may want to monitor you more closely. Symptoms include shortness of breath or swelling of your ankles and feet.
- **Allergic reactions.** Some patients have had allergic reactions to ENBREL. If you develop a severe rash, swollen face or difficulty breathing while taking ENBREL, call your doctor right away.
- **Malignancies.** Patients with inflammatory diseases including RA, AS or PsO, particularly those with highly active disease, may be at higher risk for lymphoma (a type of cancer). For children and adults taking TNF-blocker medicines including ENBREL, the chances of getting lymphoma or other cancers may increase. Whether treatment with ENBREL might influence the development and course of malignancies in adults is unknown.
- **Liver problems** (autoimmune hepatitis). Liver problems can happen in people who use TNF-blocker medicines, including ENBREL. These problems can lead to liver failure and death. Call your doctor right away if you have any of these symptoms: feel very tired, skin or eyes look yellow, poor appetite or vomiting, pain on the right side of your stomach (abdomen). These symptoms may occur several months after starting and even after ENBREL has been stopped.
- **Psoriasis.** Some people using ENBREL developed new psoriasis or worsening of psoriasis they already had. Tell your doctor if you develop red scaly patches or raised bumps which may be filled with pus. Your doctor may decide to stop your treatment with ENBREL.
- **Serious infections.** ENBREL can lower the ability of your immune system to fight infections. So, taking ENBREL can make you more prone to getting infections or make any infection that you may have worse. Some people have serious infections while taking ENBREL including infections that spread through the body such as tuberculosis (TB), legionellosis (usually a bacterial pneumonia), and listeriosis (usually from contaminated food). Other infections caused by viruses, fungi, bacteria or parasites may occur. Some people have died from these infections.

Can I take ENBREL if I am pregnant or breastfeeding?

The safe use of ENBREL has not been established in pregnant women.

You should tell your doctor if you are pregnant, become pregnant or are thinking about becoming pregnant. If you took ENBREL during pregnancy, talk to your doctor prior to administration of live vaccines to your infant.

ENBREL can pass into breast milk. ENBREL has not been studied in nursing mothers, and therefore its effects on nursing babies are not known. Talk to your healthcare provider about the best way to feed your baby while taking ENBREL.

If you are not sure or have any questions about any of this information, ask your doctor.

Tell your healthcare professional about all the medicines you take, including any drugs, vitamins, minerals, natural supplements or alternative medicines.

The following may interact with ENBREL:

It is important that you tell your doctor about any other medicines (for example, high blood pressure medicine) you are taking for other conditions before you start taking ENBREL. You should also tell your doctor about any over-the-counter drugs, herbal medicines and vitamin and mineral supplements you are taking.

If you have diabetes and are taking medication to control your diabetes, your doctor may decide you need less anti-diabetic medicine while taking ENBREL.

General Information about ENBREL

Medicines are sometimes prescribed for purposes not mentioned in the Consumer Information leaflet. **Do NOT** use ENBREL for a condition for which it was not prescribed. **Do NOT** give ENBREL to other people, even if they have the same condition.

Can I take ENBREL if I am taking other medicines for my RA, JIA, PsA, AS or other conditions?

In adults, ENBREL can be used in combination with methotrexate. However, little is known of the interaction of ENBREL with methotrexate and other drugs in children with JIA.

Taking ENBREL with Kineret® (anakinra) is not recommended because this may increase your risk of getting a serious infection.

Taking ENBREL with Orencia® (abatacept) is not recommended because this may increase your risk for serious side effects.

Taking ENBREL with cyclophosphamide (used to treat cancer or immune diseases) is not recommended. You may have a higher chance for getting certain cancers when taking ENBREL with cyclophosphamide.

How to take ENBREL:

ENBREL is given as an injection under the skin.

You may continue to use other medicines that help treat your condition while taking ENBREL, such as non-steroidal anti-inflammatory drugs (NSAIDs) and prescription steroids, as recommended by your doctor.

Usual dose:

If you have RA, PsA or AS, the recommended dose of ENBREL for adults is 50 mg per week given as one injection using a 50 mg single-use prefilled syringe or two injections using the 25 mg* single-use prefilled syringe. Your doctor will tell you whether the two injections with the 25 mg* single-use prefilled syringe should be given on the same day once a week or on two different days (3 or 4 days apart) in the same week.

If you have PsO, the recommended starting dose of ENBREL for adult patients is a 50 mg dose twice a week (3 or 4 days apart) for 3 months. After 3 months, your doctor will tell you to reduce your dose to 50 mg once per week, using one 50 mg single-use prefilled syringe or two 25 mg* single-use prefilled syringes.

* 25 mg single-use prefilled syringe is not available in Canada

The recommended dose of ENBREL for children with JIA or PsO is based on the child's body weight. Your child's doctor will tell you the correct amount of ENBREL your child should take. **The 50 mg single-use prefilled syringe is only recommended for children weighing 63 kg (138 pounds) or more.** ENBREL should be given by, or under the supervision of, a responsible adult.

Make sure you have been shown how to inject ENBREL before you do it yourself. You can call your doctor or the toll-free information line at 1-877-9ENBREL (1-877-936-2735) if you have any questions about ENBREL or about giving yourself or your child an injection. Someone you know can also help you with your injection. Remember to take this medicine just as your doctor has told you and do not miss any doses.

Overdose:

Call your doctor if you accidentally inject ENBREL more frequently than instructed.

If you think you have taken too much ENBREL, contact your healthcare professional, hospital emergency department or regional poison control centre immediately, even if there are no symptoms.

Missed Dose:

If you forget to use ENBREL, inject your dose as soon as you remember. Then, take your next dose at your regular(ly) scheduled time. In case you are not sure when to inject ENBREL, call your healthcare provider. A toll-free information service is also available: 1-877-9ENBREL (1-877-936-2735).

Instructions for preparing and giving an injection of ENBREL:

The following instructions are for preparing and giving a dose of ENBREL using a single-use prefilled syringe.

STEP 1: Setting up for an injection

1. Select a clean, well-lit, flat working surface, such as a table.
2. Take the ENBREL carton containing the prefilled syringes out of the refrigerator and place it on your flat working surface. Remove one prefilled syringe and place it on your working surface. **Do NOT** shake the prefilled syringe of ENBREL. Place the carton containing any remaining prefilled syringes back into the refrigerator (2°C to 8°C). **Do NOT** freeze. You may also store the carton of unused prefilled syringes at room temperature, up to 27°C for up to 60 days. If you have any questions about storage, contact your doctor, nurse, or pharmacist for further instructions.
3. Check the expiration date on the prefilled syringe. If the expiration date has passed, or if it has been stored at room temperature beyond 60 days (whichever comes first), **do NOT** use the prefilled syringe and contact your pharmacist or call 1-877-9ENBREL (1-877-936-2735) for assistance.
4. **Do NOT** use the prefilled syringe if the needle cover is missing or not securely attached. Call 1-877-9ENBREL (1-877-936-2735).
5. For a more comfortable injection, allow the ENBREL in the prefilled syringe to reach room temperature (approximately 15 to 30 minutes). **Do NOT** remove the needle cover while allowing it to reach room temperature. **Do NOT** warm ENBREL in any other way (for example, **do NOT** warm it in a microwave oven or in hot water).

6. Assemble the additional supplies you will need for your injection. These include an alcohol swab, a cotton ball or gauze, and a sharps disposal container (see **Step 4: Disposing of Supplies**).
7. Wash your hands thoroughly with soap and warm water.
8. Make sure the solution in the prefilled syringe is clear and colourless. You may notice small white particles in the solution. These particles are formed from ENBREL and this is acceptable. However, **do NOT inject the solution if it is cloudy or discoloured, or contains large or coloured particles** or if the prefilled syringe appears cracked or broken. Call 1-877-9ENBREL (1-877-936-2735) for assistance.

STEP 2: Choosing and Preparing an Injection Site

1. Three recommended injection sites for ENBREL using a prefilled syringe include the:
 - front of the middle thigh;
 - abdomen (stomach area), except for the **five-centimetre** (two-inch) area right around the navel (belly button); and
 - outer area of the upper arm.

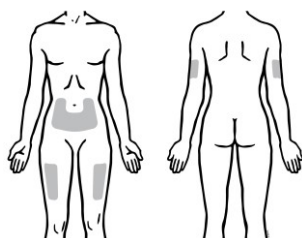

Front

Back

2. Rotate the site for each injection. Make sure that the new injection is given at least one inch from sites of recent injections. **Do NOT** inject into areas where the skin is tender, bruised, red, or hard. Avoid areas with scars or stretch marks.
3. If you have psoriasis, you should try not to inject directly into any raised, thick, red, or scaly skin patches (“psoriasis skin lesions”).
4. To prepare the area of skin where ENBREL is to be injected, wipe the injection site with an alcohol swab. **Do NOT** touch this area again before giving the injection.

STEP 3: Injecting ENBREL Using a Prefilled Syringe

Do NOT remove the needle cover from the prefilled syringe until you are ready to inject.

1. Pick up the prefilled syringe from your flat working surface. Hold the barrel of the prefilled syringe with one hand and pull the needle cover straight off. To avoid damaging the needle, **do NOT** twist or bend the needle cover while you are removing it, and **do NOT** try to put the needle cover back onto the prefilled syringe. When you remove the needle cover, there may be a drop of liquid at the end of the needle; this is normal. **Do NOT** touch the needle or allow it to touch any surface. **Do NOT** touch or bump the plunger. Doing so could cause the liquid to leak out.
2. Holding the syringe with the needle pointing up, check the syringe for air bubbles, gently tap the syringe with your finger until the air bubbles rise to the top of the syringe. Slowly push the plunger up to force the air bubbles out of the syringe.

3. Holding the syringe in one hand like a pencil, use the other hand to gently pinch a fold of skin at the cleaned injection site and hold it firmly.
4. Insert the needle at a slight angle (45 degrees) to the skin. With a quick, “dart like” motion insert the needle into the skin.

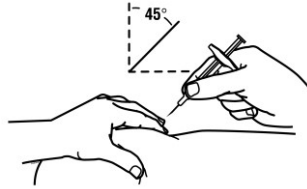

5. After the needle is inserted, let go of the skin. Slowly push the plunger all the way down to inject ENBREL.
6. When the syringe is empty, remove the needle from the skin, being careful to keep it at the same angle it was when it was inserted.
7. Slight bleeding may occur. If needed, press a cotton ball or gauze over the injection site for 10 seconds. **Do NOT** rub the injection site. If needed, you may cover the injection site with a bandage.

STEP 4: Disposing of Supplies

- The syringe should **NEVER** be reused. **NEVER** recap a needle.
- Immediately throw away the used syringe in a sharps disposal container. A container made specifically for disposing of used syringes and needles may be used. **Do NOT** recycle the container.
- Keep the container out of the reach of children. When the container is about two-thirds full, dispose of it as instructed by your/your child’s doctor, nurse, or pharmacist. Follow any special provincial or local laws regarding the proper disposal of needles and syringes.
- Used alcohol swabs should be placed in the trash.

All questions should be handled by a doctor, nurse, or pharmacist familiar with ENBREL. A toll-free information service is also available: 1-877-9ENBREL (1-877-936-2735).

What are possible side effects from using ENBREL?

Like all medicines, ENBREL can cause side effects. Most side effects are mild to moderate. However, some may be serious and require treatment.

What are the common side effects?

In studies comparing ENBREL to placebo (inactive injection), side effects that occurred more frequently in patients treated with ENBREL were:

- Reactions where the injection was given. These reactions are usually mild and include redness, swelling, itching, or bruising. These usually go away within 3 to 5 days. If you have pain, redness or swelling around the injection site that doesn’t go away or gets worse, call your doctor.
- Upper respiratory infections (sinus infections)
- Headaches

These are not all the possible side effects you may feel when taking ENBREL. If you experience any side effects not listed here, contact your healthcare professional.

Serious side effects and what to do about them			
Symptom / effect	Talk to your healthcare professional		Stop taking drug and get immediate medical help
	Only if severe	In all cases	
VERY COMMON Injection site reactions		√	
COMMON Upper respiratory tract infections (sinus infections)		√	
Headaches	√		
UNCOMMON Serious infections		√	√
Tuberculosis		√	
Nerve disorders		√	

If you have a troublesome symptom or side effect that is not listed here or becomes bad enough to interfere with your daily activities, talk to your healthcare professional.

Reporting Side Effects

You can report any suspected side effects associated with the use of health products to Health Canada by:

- Visiting the Web page on [Adverse Reaction Reporting \(http://www.hc-sc.gc.ca/dhp-mps/medeff/report-declaration/index-eng.php\)](http://www.hc-sc.gc.ca/dhp-mps/medeff/report-declaration/index-eng.php) for information on how to report online, by mail or by fax; or
- Calling toll-free at 1-866-234-2345.

NOTE: Contact your health professional if you need information about how to manage your side effects. The Canada Vigilance Program does not provide medical advice.

Storage:

Keep out of the reach and sight of children.

The ENBREL prefilled syringe should be refrigerated at 2°C to 8°C. **Do NOT freeze ENBREL.** Refrigerated ENBREL remains stable until the expiration date printed on the syringe.

ENBREL may be transferred to room temperature storage (up to 27°C). Upon removal from the refrigerator, it must be used within 60 days. Protect from direct sunlight, sources of heat, and humidity until ready to use.

If you want more information about ENBREL:

- Talk to your healthcare professional
- Find the full product monograph that is prepared for healthcare professionals and includes this Patient Medication Information by visiting the [Health Canada website](#); the manufacturer's website www.amgen.ca, or by contacting the ENLIVEN[®] Services information support line, toll free at: 1-877-9ENBREL (1-877-936-2735). Additional information can be found at www.enbrel.ca.

This leaflet was prepared by AMGEN CANADA INC. for IMMUNEX CORPORATION

Last revised: March 19, 2021

©2003-2021 Amgen Canada Inc., All rights reserved.

READ THIS FOR SAFE AND EFFECTIVE USE OF YOUR MEDICINE

PATIENT MEDICATION INFORMATION

^{Pr}Enbrel[®]

etanercept injection

Single-use Prefilled SureClick[®] Autoinjector

Read this carefully before you start taking **ENBREL** and each time you get a refill. This leaflet is a summary and will not tell you everything about this drug. Talk to your healthcare professional about your medical condition and treatment and ask if there is any new information about **ENBREL**.

Serious Warnings and Precautions

- **Serious infections.** There have been cases where patients taking ENBREL or other TNF-blocking agents have developed serious infections, including tuberculosis (TB) and infections caused by bacteria, viruses or fungi that have spread throughout their body. Some patients have died from these infections. In very rare cases, hepatitis B recurred in patients with previous hepatitis. If you tend to get infections easily or if you develop an infection while taking ENBREL, you should tell your doctor right away.
- **Malignancies.** There have been cases, sometimes fatal, of unusual cancers in children and teenage patients who started using TNF-blocking agents, including ENBREL, at less than 18 years of age.

What is ENBREL used for?

ENBREL is a medicine for treating people with moderate to severe forms of rheumatoid arthritis (RA), juvenile idiopathic arthritis (JIA) and a type of disease called psoriatic (sore-ee-ah-tick) arthritis (PsA). ENBREL is also for treating adults with a type of arthritis called ankylosing spondylitis (ank-e-low-sing spond-e-lie-tis) (AS). ENBREL is also for adults with moderate to severe psoriasis (sore-l-ah-sis) (PsO) and children with severe psoriasis (PsO). RA, JIA, PsA and AS are inflammatory diseases that affect the joints in your body. PsO is an inflammatory disease that affects the skin and can cause raised, thick, red and scaly patches (“psoriatic skin lesions”) that can appear anywhere on the body. PsA is usually seen in patients with PsO and affects both the joints and the skin.

How does ENBREL work?

ENBREL is a type of protein called a tumour necrosis factor (TNF) blocker that blocks the action of a substance your body makes called TNF-alpha. TNF-alpha is made by your body’s immune system. People with immune diseases like RA, JIA, PsA and PsO, as well as patients with AS, have too much TNF-alpha in their bodies, which can cause inflammation and lead to painful, swollen joints and raised thick, red, scaly patches (“psoriatic skin lesions”) that can appear anywhere on the body. ENBREL can reduce the amount of TNF in the body to normal levels, helping to treat joint damage and skin lesions. In patients with inflammatory arthritis, ENBREL may be effective in reducing signs and symptoms of inflammatory arthritis (such as pain, morning stiffness and fatigue), may help improve your ability to do simple daily activities (such as dressing, walking and climbing stairs), and may help prevent damage to your bones and joints. In patients with psoriatic skin conditions, ENBREL may be effective in clearing skin and improving quality of life (such as personal relationships, work and daily activities, and treatment satisfaction).

When can I expect to see results from taking ENBREL?

Improvement may be seen as early as 1 week after starting ENBREL in adults, and within 2 weeks in children with JIA and 4 weeks with PsO. In clinical trials, full effect was usually seen by 3 months in both adults and children and was sustained with continued treatment.

In clinical trials with PsA, one quarter of patients saw improvement in their joint symptoms within 1 month, one half of patients saw improvement within 3 months, and three quarters of patients saw improvement within 9 months of treatment with ENBREL.

During the PsA clinical trials, approximately 2% of patients treated with ENBREL stopped taking ENBREL due to side effects and up to 5% of ENBREL-treated patients stopped taking ENBREL due to lack of improvement.

What are the ingredients in ENBREL?

Medicinal ingredients: etanercept

Non-medicinal ingredients: L-arginine hydrochloride, sodium chloride, sucrose, and Water for Injection, USP.

ENBREL comes in the following dosage forms:

Single-use prefilled syringes are available in 25 mg* (0.51 mL of a 50 mg/mL solution of etanercept, minimum deliverable volume of 0.47 mL) and 50 mg (0.98 mL of a 50 mg/mL solution of etanercept, minimum deliverable volume of 0.94 mL) dosage strengths.

Single-use prefilled SureClick® autoinjectors are available in a 50 mg (0.98 mL of a 50 mg/mL of etanercept, minimum deliverable volume of 0.94 mL) dosage strength.

Multiple-use vial: ENBREL is also available as a lyophilized powder in a multiple-use vial containing 25 mg etanercept per vial.

Do not use ENBREL if you:

- have ever had an allergic reaction to ENBREL or any of the ingredients in ENBREL.

The needle cover on the prefilled syringe is composed of dry natural rubber, which is made from latex. If you know you are allergic to latex, talk to your healthcare provider before using ENBREL in the prefilled syringe.

- have an infection that has spread through your body (sepsis).

To help avoid side effects and ensure proper use, talk to your healthcare professional before you take ENBREL. Talk about any health conditions or problems you may have, including if you:

- have an infection. This could put you at risk for serious side effects from ENBREL.
- have symptoms of an infection such as fever, sweats or chills, cough or flu-like symptoms, shortness of breath, blood in your phlegm, weight loss, muscle aches, warm, red, or painful areas on your skin, sores on your body, diarrhea or stomach pain, burning when you urinate or urinate more often than normal, and feel very tired.
- have a history of infections that keep coming back or other conditions — like diabetes, HIV, or a weak immune system — that might increase your risk of infections.

* 25 mg single-use prefilled syringe is not available in Canada.

- have tuberculosis (TB), or have been in close contact with someone who has or has had TB. You will need to be evaluated for TB. Your doctor should test you for TB before starting ENBREL.
- were born in, lived in, or traveled to countries where there is a risk for getting TB. Ask your doctor if you are not sure.
- live in, have lived in or have traveled to, areas where there is a greater risk for certain kinds of fungal infections (histoplasmosis, coccidioidomycosis, blastomycosis). These infections may develop or become more severe if you take ENBREL. If you don't know if you have lived in an area where these infections are common, ask your doctor.
- have or have had hepatitis B.
- have or have had persistent numbness, tingling and muscle weakness or a disease such as multiple sclerosis, Guillain-Barré or a Guillain-Barré-like syndrome, which causes inflammation of the nervous system, either in the brain and spinal cord or nerves going to your hands and feet.
- have been newly diagnosed or are being treated for congestive heart failure.
- are scheduled to have major surgery.
- have recently received or are scheduled to receive a vaccine. All vaccines should be brought up-to-date before starting ENBREL. Patients taking ENBREL should not receive live vaccines.
- use the medication Kineret® (anakinra), Orencia® (abatacept) or cyclophosphamide (see the following may interact with ENBREL below).
- have been around someone with varicella zoster (chicken pox, shingles).

Know the medicines you take. Keep a list of them to show your doctor and pharmacist each time you get a new medicine.

Your doctor should monitor you closely for signs and symptoms of TB during treatment with ENBREL even if you have tested negative for TB. If you develop any of the symptoms of TB (a dry cough that doesn't go away, weight loss, fever, night sweats) call your doctor.

If you are not sure or have any questions about any of this information, ask your doctor.

Other warnings you should know about:

All medicines have side effects. Medicines, like ENBREL, that affect your immune system can cause serious side effects. The possible serious side effects include:

- **Nervous system diseases.** There have been rare cases of disorders that affect the nervous system of people taking ENBREL or other TNF-blockers, such as multiple sclerosis, seizures or inflammation of the nerves of the eyes. Signs that you could be experiencing a problem affecting your nervous system include: numbness or tingling throughout your body, problems with your vision, weakness in your arms and/or legs, and dizziness.
- **Blood problems.** In some patients the body may fail to produce enough of the blood cells that can help your body fight infections or help you to stop bleeding. This can lead to death. If you develop a fever that doesn't go away, bruise or bleed very easily or look very pale or feel faint, call your doctor right away. Your doctor may decide to stop treatment. Some people have also had symptoms that resemble lupus (rash on your face and arms that gets worse in the sun) that may go away when you stop taking ENBREL.

- **Heart problems.** You should also tell your doctor if you have ever been treated for heart failure. If you have, your doctor may choose not to start you on ENBREL, or may want to monitor you more closely. Symptoms include shortness of breath or swelling of your ankles and feet.
- **Allergic reactions.** Some patients have had allergic reactions to ENBREL. If you develop a severe rash, swollen face or difficulty breathing while taking ENBREL, call your doctor right away.
- **Malignancies.** Patients with inflammatory diseases including RA, AS or PsO, particularly those with highly active disease, may be at higher risk for lymphoma (a type of cancer). For children and adults taking TNF-blocker medicines including ENBREL, the chances of getting lymphoma or other cancers may increase. Whether treatment with ENBREL might influence the development and course of malignancies in adults is unknown.
- **Liver problems (autoimmune hepatitis).** Liver problems can happen in people who use TNF-blocker medicines, including ENBREL. These problems can lead to liver failure and death. Call your doctor right away if you have any of these symptoms: feel very tired, skin or eyes look yellow, poor appetite or vomiting, pain on the right side of your stomach (abdomen). These symptoms may occur several months after starting and even after ENBREL has been stopped.
- **Psoriasis.** Some people using ENBREL developed new psoriasis or worsening of psoriasis they already had. Tell your doctor if you develop red scaly patches or raised bumps which may be filled with pus. Your doctor may decide to stop your treatment with ENBREL.
- **Serious infections.** ENBREL can lower the ability of your immune system to fight infections. So, taking ENBREL can make you more prone to getting infections or make any infection that you may have worse. Some people have serious infections while taking ENBREL including infections that spread through the body such as tuberculosis (TB), legionellosis (usually a bacterial pneumonia), and listeriosis (usually from contaminated food). Other infections caused by viruses, fungi, bacteria or parasites may occur. Some people have died from these infections.

Can I take ENBREL if I am pregnant or breastfeeding?

The safe use of ENBREL has not been established in pregnant women.

You should tell your doctor if you are pregnant, become pregnant or are thinking about becoming pregnant. If you took ENBREL during pregnancy, talk to your doctor prior to administration of live vaccines to your infant.

ENBREL can pass into breast milk. ENBREL has not been studied in nursing mothers, and therefore its effects on nursing babies are not known. Talk to your healthcare provider about the best way to feed your baby while taking ENBREL.

If you are not sure or have any questions about any of this information, ask your doctor.

Tell your healthcare professional about all the medicines you take, including any drugs, vitamins, minerals, natural supplements or alternative medicines.

The following may interact with ENBREL:

It is important that you tell your doctor about any other medicines (for example, high blood pressure medicine) you are taking for other conditions before you start taking ENBREL. You

should also tell your doctor about any over-the-counter drugs, herbal medicines and vitamin and mineral supplements you are taking.

If you have diabetes and are taking medication to control your diabetes, your doctor may decide you need less anti-diabetic medicine while taking ENBREL.

General Information about ENBREL

Medicines are sometimes prescribed for purposes not mentioned in the Consumer Information leaflet. **Do NOT** use ENBREL for a condition for which it was not prescribed. **Do NOT** give ENBREL to other people, even if they have the same condition.

Can I take ENBREL if I am taking other medicines for my RA, JIA, PsA, AS or other conditions?

In adults, ENBREL can be used in combination with methotrexate. However, little is known of the interaction of ENBREL with methotrexate and other drugs in children with JIA.

Taking ENBREL with Kineret[®] (anakinra) is not recommended because this may increase your risk of getting a serious infection.

Taking ENBREL with Orencia[®] (abatacept) is not recommended because this may increase your risk for serious side effects.

Taking ENBREL with cyclophosphamide (used to treat cancer or immune diseases) is not recommended. You may have a higher chance for getting certain cancers when taking ENBREL with cyclophosphamide.

How to take ENBREL:

ENBREL is given as an injection under the skin.

You may continue to use other medicines that help treat your condition while taking ENBREL, such as non-steroidal anti-inflammatory drugs (NSAIDs) and prescription steroids, as recommended by your doctor.

Usual dose:

If you have RA, PsA or AS, the recommended dose of ENBREL for adults is 50 mg per week given as one injection using a 50 mg single-use prefilled SureClick[®] autoinjector.

If you have PsO, the recommended starting dose of ENBREL for adult patients is a 50 mg dose twice a week (3 or 4 days apart) for 3 months. After 3 months, your doctor will tell you to reduce your dose to 50 mg once per week using one 50 mg single-use prefilled SureClick[®] autoinjector.

The recommended dose of ENBREL for children with JIA or PsO is based on the child's body weight. Your child's doctor will tell you the correct amount of ENBREL your child should take.

The 50 mg single-use prefilled SureClick[®] autoinjector is only recommended for children weighing 63 kg (138 pounds) or more. ENBREL should be given by, or under the supervision of, a responsible adult.

Make sure you have been shown how to inject ENBREL before you do it yourself. You can call your doctor or the toll-free information line at 1-877-9ENBREL (1-877-936-2735) if you have any questions about ENBREL or about giving yourself or your child an injection. Someone you know can also help you with your injection. Remember to take this medicine just as your doctor has told you and do not miss any doses.

Overdose:

Call your doctor if you accidentally inject ENBREL more frequently than instructed.

If you think you have taken too much ENBREL, contact your healthcare professional, hospital emergency department or regional poison control centre immediately, even if there are no symptoms.

Missed Dose:

If you forget to use ENBREL, inject your dose as soon as you remember. Then, take your next dose at your regular(ly) scheduled time. In case you are not sure when to inject ENBREL, call your healthcare provider. A toll-free information service is also available: 1-877-9ENBREL (1-877-936-2735).

Instructions for preparing and giving an injection of ENBREL:

The following instructions are for preparing and giving a dose of ENBREL using a single-use prefilled SureClick[®] autoinjector. Your doctor, nurse, or pharmacist will tell you how much ENBREL you need and how often it should be injected. **Each ENBREL SureClick[®] autoinjector can be used one time.**

Guide to Parts

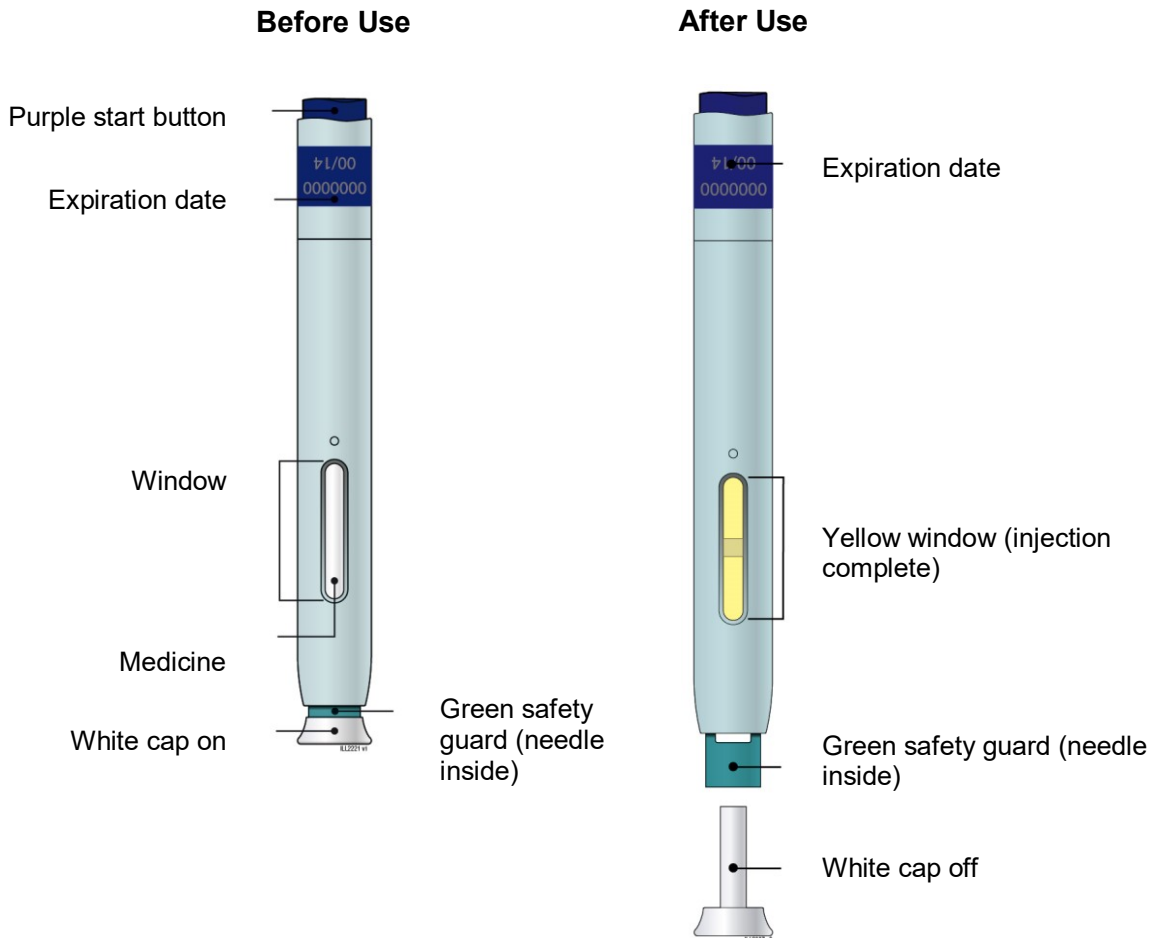

Important: Needle is inside the green safety guard.

Important

Before you use an ENBREL SureClick® autoinjector, read this important information:

Storing your ENBREL SureClick® autoinjectors

- Store the ENBREL SureClick® autoinjector in original carton to protect from light or damage.
- Store the ENBREL SureClick® autoinjector in the refrigerator at 2°C to 8°C.
- You may store the unused autoinjectors at room temperature, up to 27°C, for up to 60 days.
 - Once ENBREL has reached room temperature, do not put it back in the refrigerator.
- Do not store the ENBREL SureClick® autoinjector in extreme heat or cold.
- **Do not** freeze.
- **Do not** shake.
- **Keep ENBREL SureClick® autoinjector out of the reach of children.**

If you have any questions about storage, contact your healthcare professional or call 1-877-9ENBREL (1-877-936-2735).

Using your ENBREL SureClick® autoinjectors

- It is important that you do not try to give the injection unless you or your caregiver has received training from your healthcare professional.
- **Do not** use an ENBREL SureClick® autoinjector after the expiration date on the label or if it has been stored at room temperature beyond 60 days (whichever comes first).
- **Do not** shake the ENBREL SureClick® autoinjector.
- **Do not** remove the white cap from ENBREL SureClick® autoinjector until you are ready to inject.
- **Do not** use an ENBREL SureClick® autoinjector if it has been dropped on a hard surface. Part of the ENBREL SureClick® autoinjector may be broken even if you cannot see the break. Use a new ENBREL SureClick® autoinjector, and call 1-877-9ENBREL (1-877-936-2735).
- The white cap on ENBREL SureClick® autoinjector contains dry natural rubber, which is made from latex. Tell your healthcare professional if you are allergic to latex.
- **Children must weigh at least 63 kg (138 pounds)** to use ENBREL SureClick® autoinjector. Children who weigh less than 63 kg (138 pounds) should use a different form of ENBREL.

A healthcare professional familiar with ENBREL should be able to answer all of your questions. For more information, call 1-877-9ENBREL (1-877-936-2735).

STEP 1: Prepare

A. Remove one ENBREL SureClick® autoinjector from the package.

Carefully lift autoinjector straight up out of the box.

Put the original package with any unused autoinjectors back in the refrigerator.

You may also store the unused autoinjectors at room temperature, up to 27°C for up to 60 days.

For a more comfortable injection, leave the autoinjector at room temperature for at least **30** minutes before injecting.

Do not put the autoinjector back in the refrigerator once it has reached room temperature.

Do not try to warm the autoinjector by using a heat source such as hot water or microwave.

Do not shake the autoinjector.

Do not remove the white cap from the autoinjector yet.

B. Inspect the ENBREL SureClick® autoinjector.

Green safety guard (needle inside)

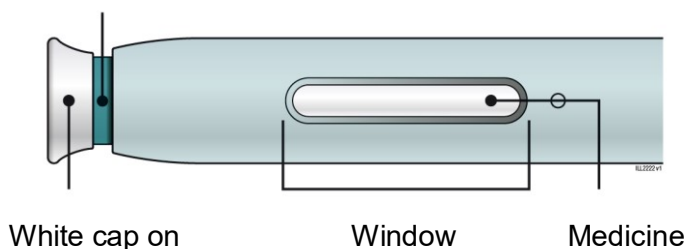

Make sure the medicine in the window is clear and colourless.

It is okay if you see small white particles in the medicine.

Do not use the autoinjector if:

- The medicine is cloudy or discoloured or contains large lumps, flakes, or coloured particles
- Any part appears cracked or broken
- The white cap is missing or not securely attached
- The expiration date printed on the label has passed or if it has been stored at room temperature beyond 60 days (whichever comes first)

In all cases, use a new autoinjector, and call 1-877-9ENBREL (1-877-936-2735).

C. Gather all materials needed for your injection.

Wash your hands thoroughly with soap and water.

On a clean, well-lit work surface, place the:

- New autoinjector
- Alcohol wipes
- Cotton ball or gauze pad
- Adhesive bandage
- Sharps disposal container. See “**Step 4: Finish**”



D. Prepare and clean your injection site.

Only use these injection sites:

- Your thigh

- Stomach area (abdomen), except for a **five-centimetre** (two inches) area right around your navel (belly button)
- Outer area of upper arm (only if someone else is giving you the injection)

Clean injection site with an alcohol wipe. Let your skin dry.

- **Do not** touch this area again before injecting.
- Choose a different site each time you give yourself an injection. If you need to use the same injection site, just make sure it is not the same spot on that site you used for the last time.
 - **Do not** inject into areas where the skin is tender, bruised, red, or hard. Avoid injecting into areas with scars or stretch marks.
- If you have psoriasis, you should avoid injecting directly into raised, thick, red, or scaly skin patch or lesion.

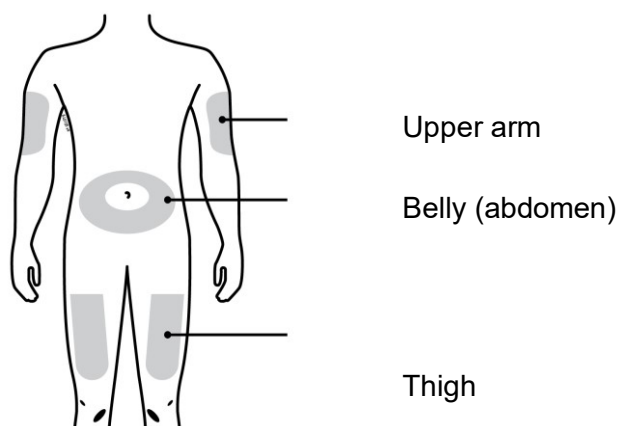

Step 2: Get ready

- E. Pull white cap straight off, only when you're ready to inject. **Do not** leave the white cap off for more than **five minutes**. This can dry out the medicine.

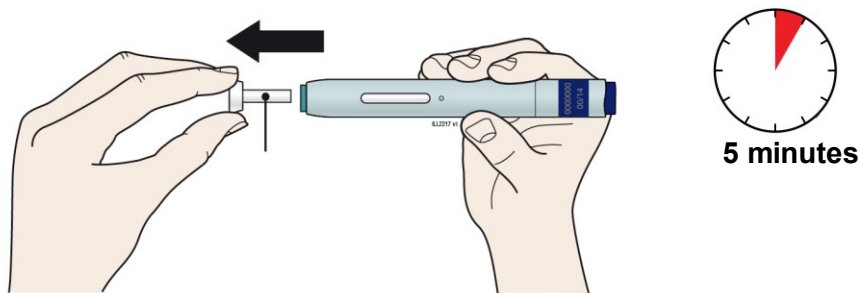

White Cap

It is normal to see a drop of liquid at the end of the needle or green safety guard.

- **Do not** twist or bend the white cap.
- **Do not** put the white cap back onto the autoinjector.
- **Do not** put fingers into the green safety guard.

- **Do not** remove the white cap from the autoinjector until you are ready to inject.

F. Create a firm surface at the selected injection site (thigh, stomach, or outer areas of the upper arm), by using the Stretch method or the Pinch method.

Stretch method

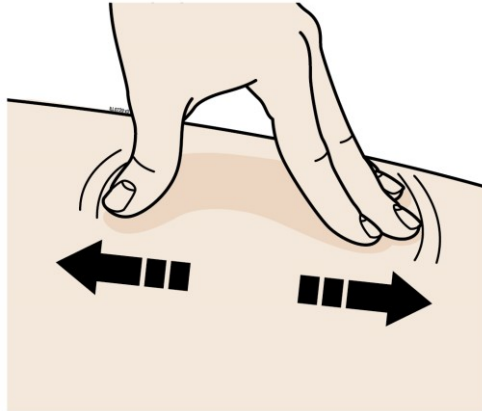

Stretch skin firmly by moving your thumb and fingers in opposite directions, creating an area about **5** centimetres (2 inches) wide.

OR

Pinch method

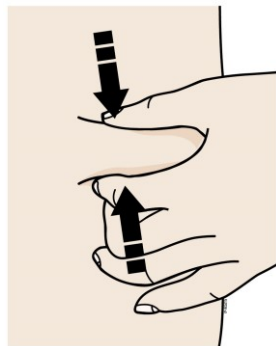

Pinch skin firmly between your thumb and fingers, creating an area about 5 centimetres (2 inches) wide.

Important: Keep the skin stretched or pinched while injecting.

STEP 3: Inject

G. Keep holding the stretched or pinched skin. With the white cap off, **put** the green safety guard on your skin at 90 degrees. The **needle is inside** the green safety guard. Do not push the purple start button yet.

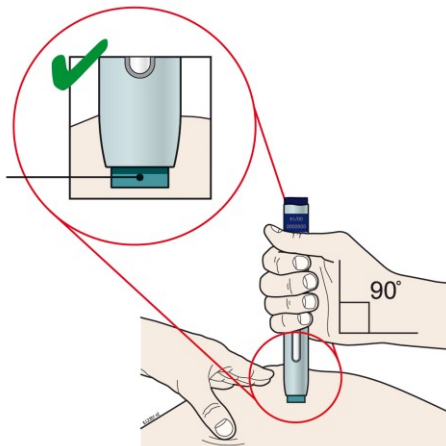

H. Firmly **push** the autoinjector down onto skin until it stops moving.

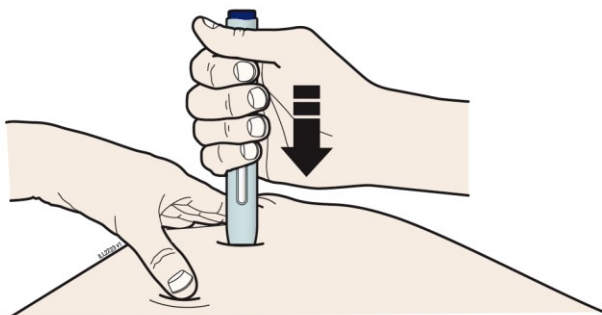

Important: You must push all the way down but do not touch the purple start button until you're ready to inject.

I. When you're ready to inject, **press** the purple start button.

“click”

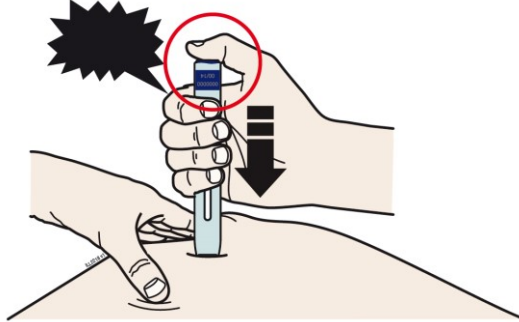

J. Keep **pushing** down on your skin. Then lift your thumb while still holding the autoinjector on your skin. Your injection could take about **15 seconds**.

“click”

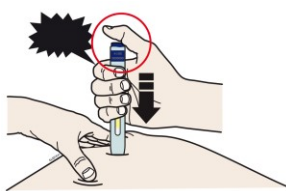

15 seconds

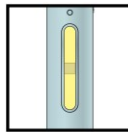

Window turns from clear to yellow when the injection is done. You may hear a second click.

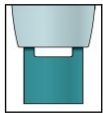

Note: After you remove autoinjector from your skin, the needle will be automatically covered.

Important: When you remove the autoinjector, if the window has not turned yellow, or if it looks like the medicine is still injecting, this means you have not received a full dose. Call your healthcare professional immediately.

Step 4: Finish

K. Discard the used autoinjector and the white cap.



Put the used SureClick® autoinjector in a sharps disposal container right away after use. **Do not** throw away (dispose of) the SureClick® autoinjector in your household trash.

If you do not have a sharps disposal container, you may use a household container that is:

- Made of a heavy-duty plastic,
- Can be closed with a tight-fitting, puncture-resistant lid without sharps being able to come out,
- Upright and stable during use,
- Leak-resistant, and
- Properly labeled to warn of hazardous waste inside the container.
- When your sharps disposal container is almost full, you will need to follow your community guidelines for the right way to dispose of your sharps disposal container. There may be provincial or local laws about how you should throw away used needles and syringes. Talk with your doctor about proper disposal. **Do not** reuse the autoinjector.
- **Do not** recycle the autoinjector or sharps disposal container or throw them into household trash.

Important: Always keep the sharps disposal container out of the reach of children.

L. Examine the injection site.

If there is blood, press a cotton ball or gauze pad on your injection site. **Do not** rub injection site. Apply an adhesive bandage if needed.

Commonly asked questions

What will happen if I press the purple start button before I am ready to do the injection on my skin?

Even when you press the purple start button, the injection will only happen when the green safety guard is also pushed into the autoinjector.

Can I move the autoinjector around on my skin while I am choosing an injection site?

It is okay to move the autoinjector around on the injection site as long as you **do not** press the purple start button. However, if you press the purple start button and the green safety guard is pushed into the autoinjector, the injection will begin.

Can I release the purple start button after I start my injection?

You can release the purple start button, but continue to hold the autoinjector firmly against your skin during the injection.

Will the purple start button pop up after I release my thumb?

The purple start button may not pop up after you release your thumb if you held your thumb down during the injection. This is okay.

What do I do if I didn't hear a second click?

If you didn't hear a second click, you can confirm a complete injection by checking that the window has turned yellow.

Whom do I contact if I need help with the autoinjector or my injection?

If you have any questions about the autoinjector or about your injection, ask your doctor, nurse, or pharmacist, or call 1-877-9ENBREL (1-877-936-2735) for help.

What are possible side effects from using ENBREL?

Like all medicines, ENBREL can cause side effects. Most side effects are mild to moderate. However, some may be serious and require treatment.

What are the common side effects?

In studies comparing ENBREL to placebo (inactive injection), side effects that occurred more frequently in patients treated with ENBREL were:

- Reactions where the injection was given. These reactions are usually mild and include redness, swelling, itching, or bruising. These usually go away within 3 to 5 days. If you have pain, redness or swelling around the injection site that doesn't go away or gets worse, call your doctor.
- Upper respiratory infections (sinus infections)
- Headaches

These are not all the possible side effects you may feel when taking ENBREL. If you experience any side effects not listed here, contact your healthcare professional.

Serious side effects and what to do about them			
Symptom / effect	Talk to your healthcare professional		Stop taking drug and get immediate medical help
	Only if severe	In all cases	
VERY COMMON Injection site reactions		√	
COMMON Upper respiratory tract infections (sinus infections)		√	
Headaches	√		
UNCOMMON Serious infections		√	√
Tuberculosis		√	
Nerve disorders		√	

If you have a troublesome symptom or side effect that is not listed here or becomes bad enough to interfere with your daily activities, talk to your healthcare professional.

<p>Reporting Side Effects</p> <p>You can report any suspected side effects associated with the use of health products to Health Canada by:</p> <ul style="list-style-type: none"> • Visiting the Web page on Adverse Reaction Reporting (http://www.hc-sc.gc.ca/dhp-mps/medeff/report-declaration/index-eng.php) for information on how to report online, by mail or by fax; or • Calling toll-free at 1-866-234-2345. <p><i>NOTE: Contact your health professional if you need information about how to manage your side effects. The Canada Vigilance Program does not provide medical advice.</i></p>
--

Storage:

The ENBREL single-use prefilled SureClick® autoinjector should be refrigerated at 2°C to 8°C. **Do not freeze. Do not shake.** Refrigerated ENBREL remains stable until the expiration date printed on the syringe.

ENBREL may be transferred to room temperature storage (up to 27°C). Upon removal from the refrigerator, it must be used within 60 days. Protect from direct sunlight, sources of heat, and humidity until ready to use.

Keep out of the reach of children.

If you want more information about ENBREL:

- Talk to your healthcare professional

- Find the full product monograph that is prepared for healthcare professionals and includes this Patient Medication Information by visiting the [Health Canada website](#); the manufacturer's website www.amgen.ca, or by contacting the ENLIVEN[®] Services information support line, toll free at: 1-877-9ENBREL (1-877-936-2735). Additional information can be found at www.enbrel.ca.

This leaflet was prepared by AMGEN CANADA INC. for IMMUNEX CORPORATION

Last revised: March 19, 2021

©2003-2021 Amgen Canada Inc., All rights reserved.

READ THIS FOR SAFE AND EFFECTIVE USE OF YOUR MEDICINE

PATIENT MEDICATION INFORMATION

^{Pr}Enbrel[®]

etanercept for injection

Multiple-use Vial

Read this carefully before you start taking **ENBREL** and each time you get a refill. This leaflet is a summary and will not tell you everything about this drug. Talk to your healthcare professional about your medical condition and treatment and ask if there is any new information about **ENBREL**.

Serious Warnings and Precautions

- **Serious infections.** There have been cases where patients taking ENBREL or other TNF-blocking agents have developed serious infections, including tuberculosis (TB) and infections caused by bacteria, viruses or fungi that have spread throughout their body. Some patients have died from these infections. In very rare cases, hepatitis B recurred in patients with previous hepatitis. If you tend to get infections easily or if you develop an infection while taking ENBREL, you should tell your doctor right away.
- **Malignancies.** There have been cases, sometimes fatal, of unusual cancers in children and teenage patients who started using TNF-blocking agents, including ENBREL, at less than 18 years of age.

What is ENBREL used for?

ENBREL is a medicine for treating people with moderate to severe forms of rheumatoid arthritis (RA), juvenile idiopathic arthritis (JIA) and a type of disease called psoriatic (sore-ee-ah-tick) arthritis (PsA). ENBREL is also for treating adults with a type of arthritis called ankylosing spondylitis (ank-e-low-sing spond-e-lie-tis) (AS). ENBREL is also for adults with moderate to severe psoriasis (sore-l-ah-sis) (PsO) and children with severe psoriasis (PsO). RA, JIA, PsA and AS are inflammatory diseases that affect the joints in your body. PsO is an inflammatory disease that affects the skin and can cause raised, thick, red and scaly patches (“psoriatic skin lesions”) that can appear anywhere on the body. PsA is usually seen in patients with PsO and affects both the joints and the skin.

How does ENBREL work?

ENBREL is a type of protein called a tumour necrosis factor (TNF) blocker that blocks the action of a substance your body makes called TNF-alpha. TNF-alpha is made by your body’s immune system. People with immune diseases like RA, JIA, PsA and PsO, as well as patients with AS, have too much TNF-alpha in their bodies, which can cause inflammation and lead to painful, swollen joints and raised thick, red, scaly patches (“psoriatic skin lesions”) that can appear anywhere on the body. ENBREL can reduce the amount of TNF in the body to normal levels, helping to treat joint damage and skin lesions. In patients with inflammatory arthritis, ENBREL may be effective in reducing signs and symptoms of inflammatory arthritis (such as pain, morning stiffness and fatigue), may help improve your ability to do simple daily activities (such as dressing, walking and climbing stairs), and may help prevent damage to your bones and joints. In patients with psoriatic skin conditions, ENBREL may be effective in clearing skin and improving quality of life (such as personal relationships, work and daily activities, and treatment satisfaction).

When can I expect to see results from taking ENBREL?

Improvement may be seen as early as 1 week after starting ENBREL in adults, and within 2 weeks in children with JIA and 4 weeks with PsO. In clinical trials, full effect was usually seen by 3 months in both adults and children and was sustained with continued treatment.

In clinical trials with PsA, one quarter of patients saw improvement in their joint symptoms within 1 month, one half of patients saw improvement within 3 months, and three quarters of patients saw improvement within 9 months of treatment with ENBREL.

During the PsA clinical trials, approximately 2% of patients treated with ENBREL stopped taking ENBREL due to side effects and up to 5% of ENBREL-treated patients stopped taking ENBREL due to lack of improvement.

What are the ingredients in ENBREL?

Medicinal ingredients: etanercept

Non-medicinal ingredients: mannitol, sucrose, tromethamine

ENBREL comes in the following dosage forms:

ENBREL is available as a lyophilized powder in a **multiple-use vial** containing 25 mg etanercept per vial.

ENBREL is also available as a **single-use prefilled syringe** in 25 mg* (0.51 mL of a 50 mg/mL solution of etanercept, minimum deliverable volume of 0.47 mL) and 50 mg (0.98 mL of a 50 mg/mL solution of etanercept, minimum deliverable volume of 0.94 mL) dosage strengths.

ENBREL **single-use prefilled SureClick® autoinjectors** are available in a 50 mg (0.98 mL of a 50 mg/mL solution of etanercept, minimum deliverable volume of 0.94 mL) dosage strength.

Do not use ENBREL if you:

- have ever had an allergic reaction to ENBREL or any of the ingredients in ENBREL.
The needle cover on the prefilled syringe is composed of dry natural rubber, which is made from latex. If you know you are allergic to latex, talk to your healthcare provider before using ENBREL in the prefilled syringe.
- have an infection that has spread through your body (sepsis).

To help avoid side effects and ensure proper use, talk to your healthcare professional before you take ENBREL. Talk about any health conditions or problems you may have, including if you:

- have an infection. This could put you at risk for serious side effects from ENBREL.
- have symptoms of an infection such as fever, sweats or chills, cough or flu-like symptoms, shortness of breath, blood in your phlegm, weight loss, muscle aches, warm, red, or painful areas on your skin, sores on your body, diarrhea or stomach pain, burning when you urinate or urinate more often than normal, and feel very tired.
- have a history of infections that keep coming back or other conditions - like diabetes, HIV, or a weak immune system — that might increase your risk of infections.

* 25 mg single-use prefilled syringe is not available in Canada.

- have tuberculosis (TB), or have been in close contact with someone who has or has had TB. You will need to be evaluated for TB. Your doctor should test you for TB before starting ENBREL.
- were born in, lived in, or traveled to countries where there is a risk for getting TB. Ask your doctor if you are not sure.
- live in, have lived in or have traveled to, areas where there is a greater risk for certain kinds of fungal infections (histoplasmosis, coccidioidomycosis, blastomycosis). These infections may develop or become more severe if you take ENBREL. If you don't know if you have lived in an area where these infections are common, ask your doctor.
- have or have had hepatitis B.
- have or have had persistent numbness, tingling and muscle weakness or a disease such as multiple sclerosis, Guillain-Barré or a Guillain-Barré-like syndrome, which causes inflammation of the nervous system, either in the brain and spinal cord or nerves going to your hands and feet.
- have been newly diagnosed or are being treated for congestive heart failure.
- are scheduled to have major surgery.
- have recently received or are scheduled to receive a vaccine. All vaccines should be brought up-to-date before starting ENBREL. Patients taking ENBREL should not receive live vaccines.
- use the medication Kineret® (anakinra), Orencia® (abatacept) or cyclophosphamide (see The following may interact with ENBREL below).
- have been around someone with varicella zoster (chicken pox, shingles).

Know the medicines you take. Keep a list of them to show your doctor and pharmacist each time you get a new medicine.

Your doctor should monitor you closely for signs and symptoms of TB during treatment with ENBREL even if you have tested negative for TB. If you develop any of the symptoms of TB (a dry cough that doesn't go away, weight loss, fever, night sweats) call your doctor.

If you are not sure or have any questions about any of this information, ask your doctor.

Other warnings you should know about:

All medicines have side effects. Medicines, like ENBREL, that affect your immune system can cause serious side effects. The possible serious side effects include:

- **Nervous system diseases.** There have been rare cases of disorders that affect the nervous system of people taking ENBREL or other TNF-blockers, such as multiple sclerosis, seizures or inflammation of the nerves of the eyes. Signs that you could be experiencing a problem affecting your nervous system include: numbness or tingling throughout your body, problems with your vision, weakness in your arms and/or legs, and dizziness.
- **Blood problems.** In some patients the body may fail to produce enough of the blood cells that can help your body fight infections or help you to stop bleeding. This can lead to death. If you develop a fever that doesn't go away, bruise or bleed very easily or look very pale or feel faint, call your doctor right away. Your doctor may decide to stop treatment. Some people have also had symptoms that resemble lupus (rash on your face and arms that gets worse in the sun) that may go away when you stop taking ENBREL.

- **Heart problems.** You should also tell your doctor if you have ever been treated for heart failure. If you have, your doctor may choose not to start you on ENBREL, or may want to monitor you more closely. Symptoms include shortness of breath or swelling of your ankles and feet.
- **Allergic reactions.** Some patients have had allergic reactions to ENBREL. If you develop a severe rash, swollen face or difficulty breathing while taking ENBREL, call your doctor right away.
- **Malignancies.** Patients with inflammatory diseases including RA, AS or PsO, particularly those with highly active disease, may be at higher risk for lymphoma (a type of cancer). For children and adults taking TNF-blocker medicines including ENBREL, the chances of getting lymphoma or other cancers may increase. Whether treatment with ENBREL might influence the development and course of malignancies in adults is unknown.
- **Liver problems (autoimmune hepatitis).** Liver problems can happen in people who use TNF-blocker medicines, including ENBREL. These problems can lead to liver failure and death. Call your doctor right away if you have any of these symptoms: feel very tired, skin or eyes look yellow, poor appetite or vomiting, pain on the right side of your stomach (abdomen). These symptoms may occur several months after starting and even after ENBREL has been stopped.
- **Psoriasis.** Some people using ENBREL developed new psoriasis or worsening of psoriasis they already had. Tell your doctor if you develop red scaly patches or raised bumps which may be filled with pus. Your doctor may decide to stop your treatment with ENBREL.
- **Serious infections.** ENBREL can lower the ability of your immune system to fight infections. So, taking ENBREL can make you more prone to getting infections or make any infection that you may have worse. Some people have serious infections while taking ENBREL including infections that spread through the body such as tuberculosis (TB), legionellosis (usually a bacterial pneumonia), and listeriosis (usually from contaminated food). Other infections caused by viruses, fungi, bacteria or parasites may occur. Some people have died from these infections.

Can I take ENBREL if I am pregnant or breastfeeding?

The safe use of ENBREL has not been established in pregnant women.

You should tell your doctor if you are pregnant, become pregnant or are thinking about becoming pregnant. If you took ENBREL during pregnancy, talk to your doctor prior to administration of live vaccines to your infant.

ENBREL can pass into breast milk. ENBREL has not been studied in nursing mothers, and therefore its effects on nursing babies are not known. Talk to your healthcare provider about the best way to feed your baby while taking ENBREL.

If you are not sure or have any questions about any of this information, ask your doctor.

Tell your healthcare professional about all the medicines you take, including any drugs, vitamins, minerals, natural supplements or alternative medicines.

The following may interact with ENBREL:

It is important that you tell your doctor about any other medicines (for example, high blood pressure medicine) you are taking for other conditions before you start taking ENBREL. You should also tell your doctor about any over-the-counter drugs, herbal medicines and vitamin and mineral supplements you are taking.

If you have diabetes and are taking medication to control your diabetes, your doctor may decide you need less anti-diabetic medicine while taking ENBREL.

General Information about ENBREL

Medicines are sometimes prescribed for purposes not mentioned in the Consumer Information leaflet. **Do NOT** use ENBREL for a condition for which it was not prescribed. **Do NOT** give ENBREL to other people, even if they have the same condition.

Can I take ENBREL if I am taking other medicines for my RA, JIA, PsA, AS or other conditions?

In adults, ENBREL can be used in combination with methotrexate. However, little is known of the interaction of ENBREL with methotrexate and other drugs in children with JIA.

Taking ENBREL with Kineret[®] (anakinra) is not recommended because this may increase your risk of getting a serious infection.

Taking ENBREL with Orencia[®] (abatacept) is not recommended because this may increase your risk for serious side effects.

Taking ENBREL with cyclophosphamide (used to treat cancer or immune diseases) is not recommended. You may have a higher chance for getting certain cancers when taking ENBREL with cyclophosphamide.

How to take ENBREL:

ENBREL is given as an injection under the skin.

You may continue to use other medicines that help treat your condition while taking ENBREL, such as non-steroidal anti-inflammatory drugs (NSAIDs) and prescription steroids, as recommended by your doctor.

Usual dose:

If you have RA, PsA or AS, the recommended dose of ENBREL for adults is 50 mg per week (two 25 mg injections). Your doctor will tell you whether the two injections should be given on the same day once a week or on two different days (3 or 4 days apart) in the same week.

If you have PsO, the recommended dose of ENBREL is a 50 mg dose given twice a week (3 or 4 days apart) given for 3 months. After 3 months, your doctor will tell you to reduce your dose to 50 mg once per week.

The recommended dose of ENBREL for children with JIA or PsO is based on the child's body weight. Your child's doctor will tell you the correct amount of ENBREL your child should take and whether the dose should be given as one or two injections. Your child's doctor will also tell you whether the injection or injections should be given on the same day once a week or on two different days (3 or 4 days apart) in the same week. ENBREL should be given by, or under the supervision of, a responsible adult.

Make sure you have been shown how to inject ENBREL before you do it yourself. You can call your doctor or the toll-free information line at 1-877-9ENBREL (1-877-936-2735) if you have any

questions about ENBREL or about giving yourself or your child an injection. Someone you know can also help you with your injection. Remember to take this medicine just as your doctor has told you and do not miss any doses.

Overdose:

Call your doctor if you accidentally inject ENBREL more frequently than instructed.

If you think you have taken too much ENBREL, contact your healthcare professional, hospital emergency department or regional poison control centre immediately, even if there are no symptoms.

Missed Dose:

If you forget to use ENBREL, inject your dose as soon as you remember. Then, take your next dose at your regular(ly) scheduled time. In case you are not sure when to inject ENBREL, call your healthcare provider. A toll-free information service is also available: 1-877-9ENBREL (1-877-936-2735).

Instructions for preparing and giving an injection of ENBREL:

The following instructions are for preparing and giving a dose of ENBREL.

STEP 1: Setting Up for an Injection

1. Select a clean, well-lit, flat working surface, such as a table.
2. Take the ENBREL dose tray out of the refrigerator (2° to 8°C) and place it on your flat working surface.
You may also store the unopened dose tray at room temperature, up to 27°C for up to 60 days. **Do NOT** freeze. If you have any questions about storage, contact your doctor, nurse or pharmacist for further instructions.
3. Wash your hands thoroughly with soap and warm water.
4. Peel the paper seal off the dose tray and remove the contents.

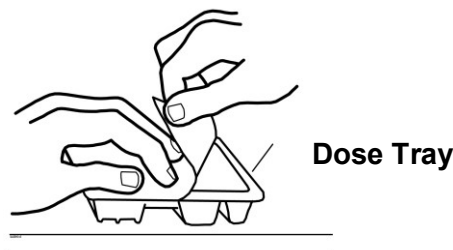

5. The dose tray should contain the items shown in the diagram below. If any of the items are missing or if any item looks damaged, **do NOT** use the dose tray and consult your pharmacist, or call 1-877-9ENBREL (1-877-936-2735). Use only these items. The prefilled diluent syringe is specially designed for the preparation and administration of ENBREL. **Do NOT** use any other syringe.

- One prefilled diluent syringe containing 1 mL of liquid diluent, with attached adapter twist-off cap
- One plunger
- One ENBREL vial
- One 27-gauge needle in hard plastic cover
- One vial adapter

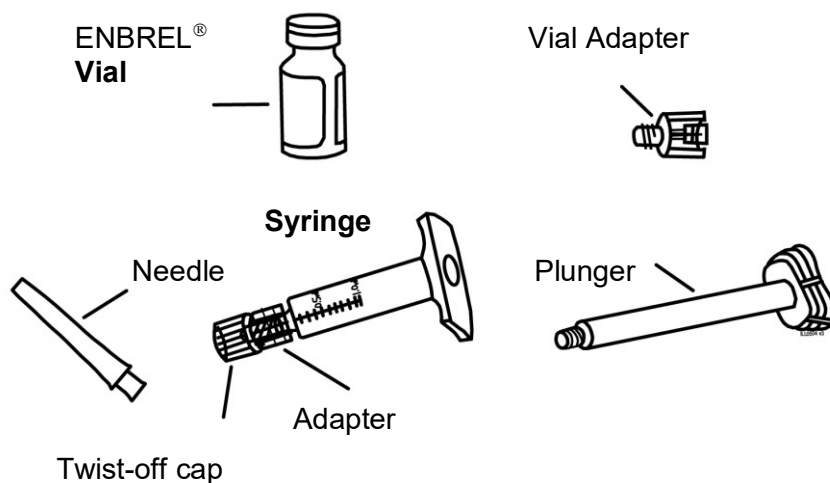

Alcohol swabs will also be required for injections and will need to be obtained or purchased separately.

6. Inspect the expiration (Exp.) dates on both the ENBREL vial label and prefilled diluent syringe label. The dates should be the current month and year or later. If the expiration date has passed, or if the unopened dose tray has been stored at room temperature beyond 60 days (whichever comes first), **do NOT** use the ENBREL vial or prefilled diluent syringe. Contact your pharmacist or call 1-877-9ENBREL (1-877-936-2735) for assistance.
7. Inspect the volume of diluent in the syringe with the twist-off cap pointing down. Use the unit markings on the side of the syringe to make sure there is at least 1 mL of liquid in the syringe. **Do NOT** use the diluent syringe **if the level of liquid is below the 1 mL mark or appears to be cracked or broken.** Call 1-877-9ENBREL (1-877-936-2735) for assistance.
8. **Do NOT** use the syringe if the twist-off cap is missing or not securely attached. Call 1-877-9ENBREL (1-877-936-2735).

STEP 2: Preparing the ENBREL Solution

There are two methods for preparing the ENBREL solution: one for single-use administration (Vial Adapter Method) and one for multiple-use administration in children (Free-hand Method). For some children, one vial of ENBREL solution can be used for more than one dose. The free-hand method should be used for children on ENBREL who are using one vial of ENBREL solution for more than one dose. **You should not use the vial adapter method if you will be using the vial more than once.** Ask your healthcare provider if you have questions about which method to use.

- **Vial Adapter Method:** Adult patients and children who use an entire vial of ENBREL should use the vial adapter device to assist with mixing the powder with the liquid and withdrawing ENBREL. A 27-gauge needle should be attached to the syringe to inject the dose. **This method should not be used for children withdrawing multiple doses from the same vial of ENBREL.** Instructions on using the vial adapter method are outlined in STEP 2A.
- **Free-hand Method:** For some children, one vial of ENBREL solution can be used for more than one dose. The free-hand method should be used for multiple-use administration in children on ENBREL, using a 25-gauge needle to assist with mixing the powder with the liquid and switching to a 27-gauge needle to inject the dose.

The instructions on preparing additional doses from the same vial are in STEP 2B. For each additional dose, you will need two new needles (one 25-gauge needle to withdraw the solution and one 27-gauge needle for the injection) and one new empty syringe (1 mL). **NEVER REUSE A SYRINGE OR NEEDLE.**

If you are using the vial of ENBREL for more than one dose, you should write the date you mixed the powder and liquid in the area marked "Mixing Date:" on the supplied sticker and attach the sticker to the ENBREL vial. After you have withdrawn the dose of ENBREL that you need, you must store the vial (in the dose tray) in the refrigerator at 2° to 8°C as soon as possible, but always within 4 hours of mixing the solution.

The reconstituted ENBREL solution must be used within 14 days after the mixing date if stored in the original vial at 2° to 8°C, with overall room temperature exposure of less than 12 hours during storage and handling. You should discard the vial and any remaining solution if it is not used within 14 days.

THE STABILITY AND STERILITY OF THE MIXED ENBREL SOLUTION CANNOT BE GUARANTEED AFTER 14 DAYS.

STEP 2A: Vial Adapter Method – For Single Use Only

To use the Vial Adapter Method, follow the steps below:

1. Remove the pink plastic cap from the ENBREL vial. **Do NOT** remove the gray stopper or silver metal ring around the top of the ENBREL vial.



2. Place your ENBREL vial on a flat working surface or turn your dose tray upside down and place your ENBREL vial in the round space marked "V". Use one alcohol swab to clean the gray stopper on the ENBREL vial. **Do NOT** touch the stopper with your hands.
3. Partially open (only open part of) the package that contains the 27-gauge needle by peeling apart the tabs, and set aside. Open the package with the vial adapter by peeling apart the tabs. **Do NOT** touch the vial adapter's twist - on end or the spike inside.

27 Gauge Needle

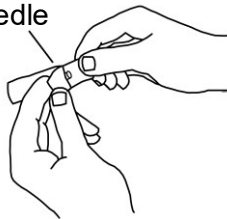

Vial Adapter

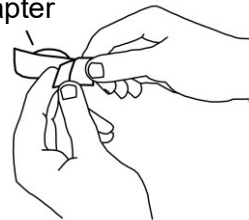

4. Slide the plunger into the syringe. Attach the plunger to the gray rubber stopper in the syringe by turning the plunger clockwise three times or until a slight resistance is felt.

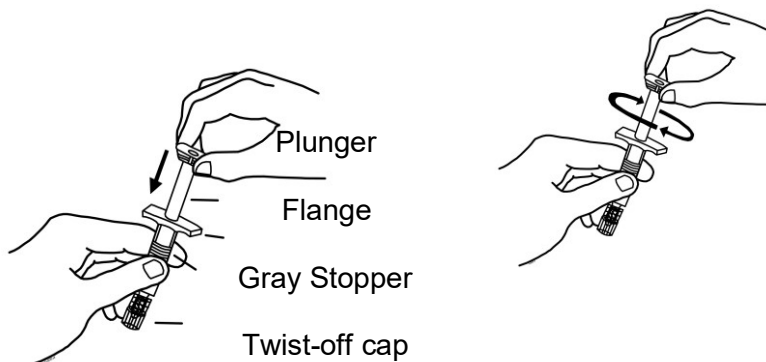

5. Remove the twist-off cap from the prefilled diluent syringe by turning counter-clockwise. **Do NOT** bump or touch the plunger; doing so could cause the liquid to leak out. You may see a drop of liquid when removing the twist cap—this is normal. Once the twist cap is removed, holding the syringe and the vial adapter, twist the vial adapter onto the syringe, turning clockwise, until a slight resistance is felt. **Do NOT over-tighten.**

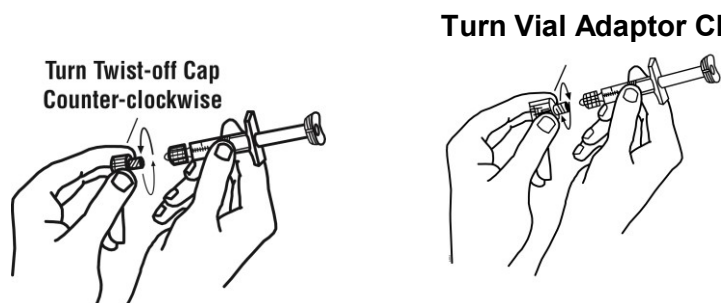

6. Hold your ENBREL vial on a flat surface, grasp the sides of the vial adapter and place it over the top of the ENBREL vial. **Do NOT** bump or touch the plunger; doing so could cause the liquid to leak out. Press down until the vial adapter attaches to the ENBREL vial. The plastic spike inside the vial adapter should puncture the gray stopper. The vial adapter should fit snugly.

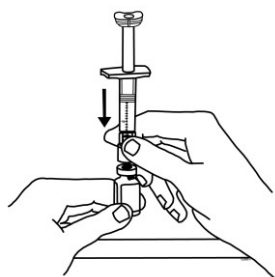

7. Hold the ENBREL vial upright on your flat work surface and press the plunger down until all the liquid from the syringe is in the ENBREL vial. You may see foaming (bubbles) in the vial—this is normal.

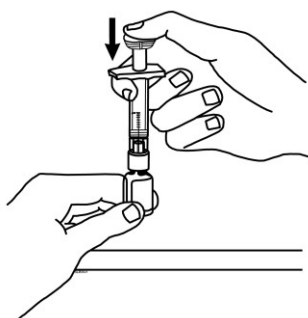

8. Gently swirl the ENBREL vial between fingers in a circular motion to dissolve the powder (see illustration). If you used the dose tray to hold your ENBREL vial, take the vial (with the vial adapter and syringe still attached) out of the dose tray, and gently swirl in a circular motion to dissolve the powder. **DO NOT SHAKE.** Wait until all the powder dissolves (usually less than 10 minutes). The solution should be clear and colourless. After the

powder has completely dissolved, foam (bubbles) may still be present. This is normal. **Do NOT inject the solution if it is cloudy or discoloured, or if it contains large or coloured particles.** If all the powder in the ENBREL vial is not dissolved or there are particles present after 10 minutes, call 1-877-9ENBREL (1-877-936-2735) for assistance. **DO NOT WITHDRAW THE ENBREL SOLUTION INTO THE SYRINGE UNTIL YOU ARE READY TO INJECT.**

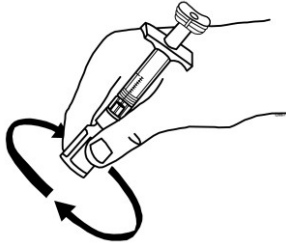

9. Turn the ENBREL vial upside down. Push the plunger all the way in to remove air from the syringe. Holding the syringe at eye level, slowly pull the plunger down to remove the entire volume (1 mL), unless otherwise instructed by your doctor. Be careful not to pull the plunger completely out of the syringe. Some white foam may remain in the ENBREL vial—this is normal.

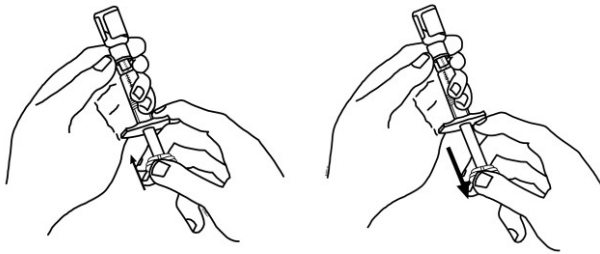

10. Check for air bubbles in the syringe. Gently tap the syringe to make any air bubbles rise to the top of the syringe. Slowly push the plunger up to remove the air bubbles. If you push solution back into the vial, slowly pull back on the plunger to draw the correct amount of solution back into the syringe.
11. To remove the syringe from the vial adapter, grasp the vial adapter and untwist the syringe. **Do NOT** touch or bump the plunger; doing so could cause the solution to leak out. Place the ENBREL vial with the vial adapter on your flat work surface. With the needle cover still on, in the partially opened paper packaging, twist the new 27-gauge needle onto the syringe until it fits snugly. Remove the paper packaging from the needle cover. Pull the hard plastic needle cover straight off the syringe. **Do NOT** touch the needle or allow it to touch any surface. You are now ready to inject ENBREL.

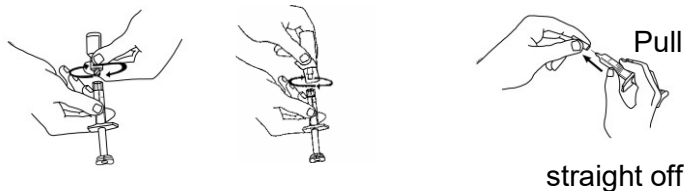

GO TO STEP 4 CHOOSING AND PREPARING AN INJECTION SITE.

STEP 2B: Free-hand Method – For Use in Children

If you are preparing a dose from an ENBREL vial that was previously used, go to STEP 3: Preparing Additional Doses from Multiple-use ENBREL Vials.

1. Remove the pink plastic cap from the ENBREL vial. **Do NOT** remove the gray stopper or silver metal ring around the top of the vial. Write the mixing date on the supplied “Mixing Date:” sticker and attach it to the ENBREL vial.



2. Use a new alcohol swab to clean the gray stopper on the ENBREL vial. After cleaning, place the ENBREL vial upright on a flat working surface. **Do NOT** touch the stopper with your hands.
3. Partially open (only open part of) the package that contains the 25-gauge needle by peeling apart the tabs, and set aside. The 25-gauge needle will be used to mix the liquid with the powder and for withdrawing ENBREL from the vial.
4. Slide the plunger into the flange end of the syringe, turning clockwise three times or until the plunger is attached to the gray stopper in the syringe.

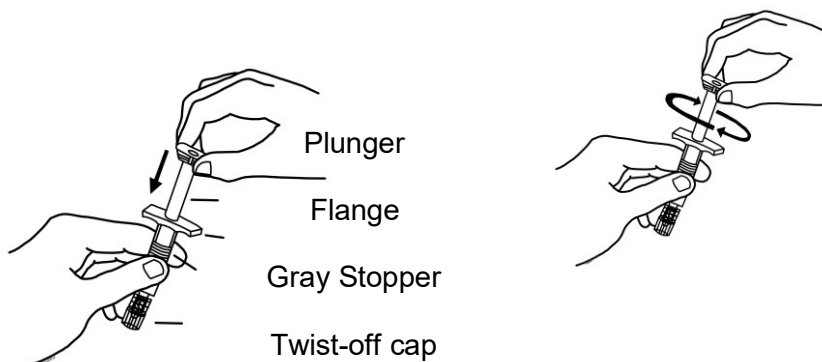

5. Remove the twist-off cap from the prefilled diluent syringe by turning counter-clockwise. Do NOT touch or bump the plunger; doing so could cause the solution to leak out. You may see a drop of liquid when removing the twist-off cap—this is normal. With the needle cover still on, in the partially opened paper packaging, twist the 25-gauge needle onto the syringe, until it fits snugly. Place the syringe on your flat work surface.



6. Prepare the 27-gauge needle by partially opening (only open part of) the package by peeling back the tabs; and set aside for later use. The 27-gauge needle will be used to inject ENBREL once the powder is mixed with the liquid.

27 Gauge Needle

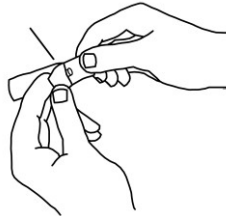

7. Hold the barrel of the syringe with one hand and remove the paper packaging off the 25-gauge needle. Pull the hard plastic needle cover straight off. To avoid damaging the needle, **do NOT** twist or bend the needle cover while you are removing it. **Do NOT** touch the needle or allow it to touch any surface. **Do NOT** touch or bump the plunger; doing so could cause the solution to leak out. Place the hard plastic needle cover (open side up) in the round space marked “N” in the ENBREL dose tray.

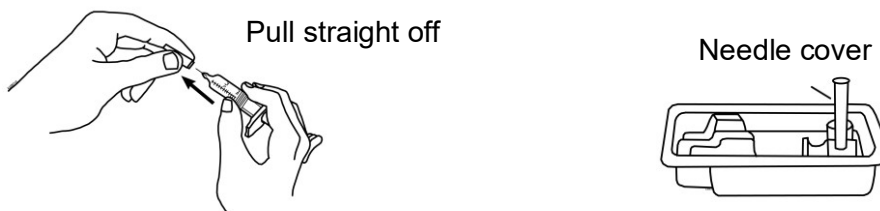

8. Place the ENBREL vial upright on the flat working surface. Hold the syringe with the needle facing up, and gently pull back on the plunger to pull a small amount of air into the syringe. Insert the needle straight down through the centre ring of the gray stopper (see illustrations). If the needle is correctly lined up, you should feel a slight resistance and then a “pop” as the needle goes through the centre of the stopper. Look for the needle tip inside the stopper window. If the needle is not correctly lined up with the centre of the stopper, you will feel a constant resistance as it goes through the stopper and no “pop”. The needle may enter at an angle and bend, break or prevent proper addition of the diluent into the ENBREL vial.

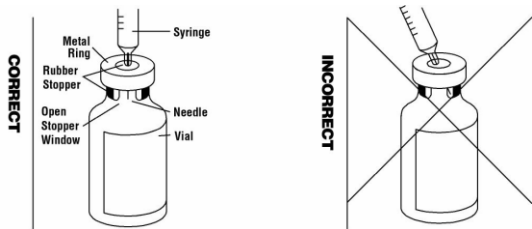

9. Push the plunger down **VERY SLOWLY** until all liquid from the syringe is in the ENBRELEL vial. Adding the liquid too fast will cause foaming (bubbles).

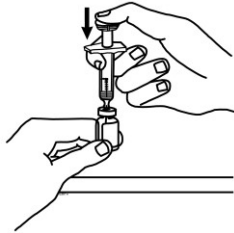

10. Leave the syringe in place. Gently swirl the ENBRELEL vial between fingers in a circular motion to dissolve the powder (see illustration below). **DO NOT SHAKE.** Wait until all the powder dissolves (usually less than 10 minutes). The solution should be clear and colourless. After the powder has completely dissolved, foam (bubbles) may still be present. This is normal. **Do NOT inject the solution if it is cloudy or discoloured or if it contains large coloured particles.**

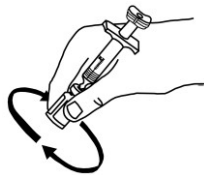

If all the powder in the ENBRELEL vial is not dissolved or there are particles present after 10 minutes, call 1-877-9ENBRELEL (1-877-936-2735) for assistance.

11. With the needle still in the vial, turn the vial upside down. Push the plunger all the way in to remove air from the syringe. Holding the syringe at eye level, slowly pull the plunger back to the mark on the side of the syringe that corresponds with the correct dose. Remove only the portion of the solution as instructed by your/your child's doctor. As the solution level drops in the vial, you may need to partially withdraw the needle to keep the tip of the needle in the solution. Be careful not to pull the plunger completely out of the syringe. Some white foam may remain in the vial—this is normal.

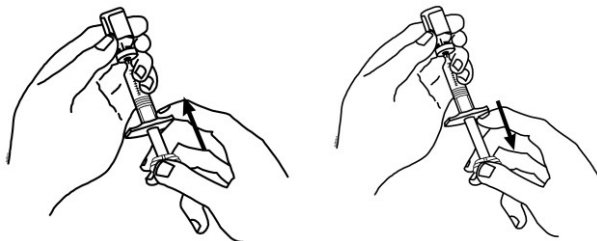

12. With the needle still inserted in the vial, check for air bubbles in the syringe. Gently tap the syringe to make any bubbles rise to the top of the syringe (see illustration below). Slowly push the plunger up to remove the air bubbles. If you push solution back into the vial, slowly pull back on the plunger to draw the correct amount of solution back into the syringe.

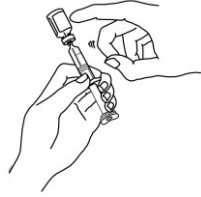

13. Remove the syringe and needle from the ENBREL vial. Again, **Do NOT** touch the needle or allow it to touch any surface. Place the 25-gauge needle back into the hard plastic needle cover in the ENBREL dose tray, and push the syringe down until the needle is attached. Once the needle is secure in the needle cover, untwist the 25-gauge needle from the syringe and dispose of the needle in your sharps disposal container.

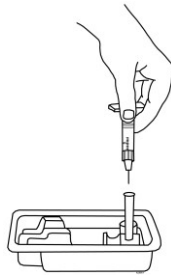

14. With the needle cover still on, in the partially opened paper packaging, twist the new 27-gauge needle onto the syringe until it fits snugly. Remove the paper packaging from the needle cover. **Do NOT** remove the needle cover from the syringe until you are ready to inject. Pull the hard plastic needle cover straight off the syringe. To avoid damaging the needle, **do NOT** twist or bend the needle cover while you are removing it, and **do NOT** try to put the needle cover back onto the syringe. When you remove the needle cover, there may be a drop of liquid at the end of the needle; this is normal. **Do NOT** touch the needle or allow it to touch any surface. You are now ready to inject ENBREL.

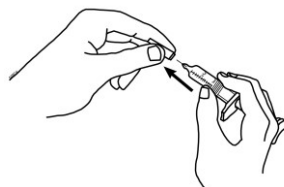
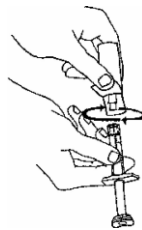

Pull straight off

GO TO STEP 4: CHOOSING AND PREPARING AN INJECTION SITE.

STEP 3: For Use In Children – Preparing Additional Doses from Multiple-use ENBREL Vials

For some children, one vial of ENBREL solution can be used for more than one dose. Your child's doctor will tell you if this is the case for your child. Contents of one vial of ENBREL solution should not be mixed with, or transferred into, the contents of another vial of ENBREL.

If you are preparing a dose from a vial that was previously used, follow the instructions below. **Do NOT** re-use needles or syringes supplied with your ENBREL.

1. Select a clean, well-lit, flat working surface, such as a table.
2. Your doctor will tell you what type of syringe and needles (1 mL Luer-lok® syringe, and 25- and 27-gauge needles) to use. Alcohol swabs are available at a drugstore. Place the new empty sterile syringe with a 25-gauge needle (for withdrawing ENBREL), a 27-gauge needle (for injecting ENBREL) and two alcohol swabs on your flat working surface.
3. Take the vial of ENBREL solution that is stored in the dose tray out of the refrigerator and place it on your flat working surface. For a more comfortable injection, allow ENBREL to reach room temperature (approximately 15 to 30 minutes).
4. Check the mixing date you wrote on the sticker on the ENBREL vial and confirm that the mixed solution is less than 14 days old. **Do NOT** inject the solution if it is cloudy or discoloured, or if it contains large or coloured particles. **Discard the vial if more than 14 days have passed since the ENBREL solution was mixed.**
5. Wash your hands with soap and warm water.
6. Use one alcohol swab to clean the gray stopper on the ENBREL vial. **Do NOT** touch the stopper with your hands.
7. If the syringe and the 25-gauge needle are not pre-assembled, assemble them as instructed by your doctor.
8. Prepare the 27-gauge needle by partially opening (only open part of) the package by peeling back the tabs. Set the 27-gauge needle aside. The 27-gauge needle will be used to inject the dose of ENBREL.
9. Hold the syringe and pull the hard plastic needle cover straight off. To avoid damaging the needle, **do NOT** twist or bend the needle cover while you are removing it. **Do NOT** touch the needle or allow it to touch any surface. Place the hard plastic needle cover (open side up) in the round space of the ENBREL dose tray marked "N".
10. Place the ENBREL vial upright on your flat working surface. Hold the syringe with the needle facing up, and gently pull back the plunger to pull a small amount of air into the syringe. Insert the 25-gauge needle straight down through the centre ring of the gray stopper. You should feel a slight resistance and then a "pop" as the needle goes through the centre of the stopper. Look for the needle tip inside the stopper window. If the needle is not correctly lined up with the centre of the stopper, you will not feel a "pop" and will feel constant resistance as you push the needle through the stopper. If you do not line the needle up correctly, it may enter at an angle and bend, break, or prevent proper withdrawal of ENBREL solution from the vial.

11. With the needle still in the vial, turn the vial upside down. Holding the syringe at eye level, slowly pull the plunger down to the mark on the syringe that corresponds to your child's dose. As the solution level drops in the vial, you may need to partially withdraw the needle to keep the tip of the needle in the solution.
12. With the needle still inserted in the vial, check for air bubbles in the syringe. Gently tap the syringe to make any air bubbles rise to the top of the syringe. Slowly push the plunger up to remove the air bubbles. If you push the solution back into the vial, slowly pull back on the plunger to draw the correct amount of solution back into the syringe.
13. Remove the syringe and needle from the ENBREL vial. **Do NOT** touch the needle or allow it to touch any surface. **Do NOT** touch or bump the plunger; doing so could cause the solution to leak out. Place the 25-gauge needle back into the hard plastic needle cover in the ENBREL dose tray, and push the syringe down until the needle is attached. Once the needle is secure in the needle cover, untwist the 25-gauge needle from the syringe and dispose of it in your sharps disposal container.
14. With the needle cover still on, in the partially opened paper packaging, twist the new 27-gauge needle onto the syringe until it fits snugly. Remove the paper packaging from the needle cover. **Do NOT** remove the needle cover from the syringe until you are ready to inject. Pull the hard plastic needle cover straight off the syringe. To avoid damaging the needle, **do NOT** twist or bend the needle cover while you are removing it, and **do NOT** try to put the needle cover back onto the syringe. When you remove the needle cover, there may be a drop of liquid at the end of the needle; this is normal. **Do NOT** touch the needle or allow it to touch any surface. You are now ready to inject ENBREL.

STEP 4: Choosing and Preparing an Injection Site

1. Choose an injection site. Three recommended injection sites for ENBREL include: (1) the front of your middle thighs; (2) the abdomen, except for the **five** centimeters (two inches) around your navel (belly button); and (3) the outer area of your upper arms.

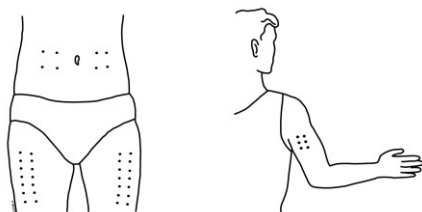

2. Rotate the site for each injection. Make sure that the new injection is given at least one inch from sites of recent injections. **Do NOT** inject into areas where the skin is tender, bruised, red, or hard. Avoid areas with scars or stretch marks.
3. To prepare the area of skin where ENBREL is to be injected, wipe the injection site with a new alcohol swab. **Do NOT** touch this area again before giving the injection.

STEP 5: Injecting the ENBREL Solution

1. With one hand, gently pinch the cleaned area of skin and hold it firmly. With the other hand, hold the syringe at about a 45° angle to the skin.



2. With a quick, “dart-like” short motion, push the needle into the skin.
3. Let go of the skin with the other hand.
4. With your free hand, slowly push the plunger down to inject ENBREL.



5. When the syringe is empty, remove the needle from the skin, being careful to keep it at the same angle it was when it was inserted.
6. Slight bleeding may occur. If needed, press a cotton ball or gauze over the injection site for 10 seconds. **Do NOT** rub the injection site. If needed, you may cover the injection site with a bandage.
7. If there is enough solution left in the ENBREL vial for another dose, write the date you mixed the powder and liquid in the area marked “Mixing Date:” on the sticker supplied with these instructions and attach the sticker to the ENBREL vial. Refrigerate the reconstituted (mixed) ENBREL vial (in the dose tray) after use. Prepare additional doses from the ENBREL vial as described in STEP 3. Otherwise, discard the ENBREL vial and any remaining solution.

STEP 6: Disposing of Supplies

1. The syringe, needle, and vial adapter should **NEVER** be reused. **NEVER** recap a needle. Instructions have been provided for children’s caregivers to help them safely switch from the 25-gauge needle used for mixing and withdrawing ENBREL to the 27-gauge needle used for injecting ENBREL.
2. Immediately throw away the used needle and syringe in a sharps disposal container. **Do NOT** remove the plunger from the syringe prior to disposal. A container made specifically for disposing of used syringes and needles may be used. **Do NOT** recycle the container.
3. Keep the container out of the reach of children. When the container is about two-thirds full, dispose of it as instructed by your/your child’s doctor, nurse, or pharmacist. Follow any special provincial or local laws regarding the proper disposal of needles and syringes.

- The ENBREL vials, vial adapters, and used swabs should be placed in the trash, unless otherwise instructed by your/your child's doctor, nurse, or pharmacist. The dose tray and cover may be recycled.

All questions should be handled by a doctor, nurse, or pharmacist familiar with ENBREL. A toll-free information service is also available: 1-877-9ENBREL (1-877-936-2735).

What are possible side effects from using ENBREL?

Like all medicines, ENBREL can cause side effects. Most side effects are mild to moderate. However, some may be serious and require treatment.

What are the common side effects?

In studies comparing ENBREL to placebo (inactive injection), side effects that occurred more frequently in patients treated with ENBREL were:

- Reactions where the injection was given. These reactions are usually mild and include redness, swelling, itching, or bruising. These usually go away within 3 to 5 days. If you have pain, redness or swelling around the injection site that doesn't go away or gets worse, call your doctor.
- Upper respiratory infections (sinus infections)
- Headaches

These are not all the possible side effects you may feel when taking ENBREL. If you experience any side effects not listed here, contact your healthcare professional.

Serious side effects and what to do about them			
Symptom / effect	Talk to your healthcare professional		Stop taking drug and get immediate medical help
	Only if severe	In all cases	
VERY COMMON Injection site reactions		√	
COMMON Upper respiratory tract infections (sinus infections)		√	
Headaches	√		
UNCOMMON Serious infections		√	√
Tuberculosis		√	
Nerve disorders		√	

If you have a troublesome symptom or side effect that is not listed here or becomes bad enough to interfere with your daily activities, talk to your healthcare professional.

Reporting Side Effects

You can report any suspected side effects associated with the use of health products to Health Canada by:

- Visiting the Web page on [Adverse Reaction Reporting](http://www.hc-sc.gc.ca/dhp-mps/medeff/report-declaration/index-eng.php) (<http://www.hc-sc.gc.ca/dhp-mps/medeff/report-declaration/index-eng.php>) for information on how to report online, by mail or by fax; or
- Calling toll-free at 1-866-234-2345.

NOTE: Contact your health professional if you need information about how to manage your side effects. The Canada Vigilance Program does not provide medical advice.

Storage:

The ENBREL dose tray containing sterile powder should be refrigerated at 2°C to 8°C. **Do NOT freeze ENBREL.** Unopened refrigerated ENBREL sterile powder remains stable until the expiration date printed on the vial.

Unopened ENBREL sterile powder may be transferred to room temperature storage (up to 27°C). Upon removal from the refrigerator, it must be used within 60 days. Protect from direct sunlight, sources of heat, and humidity until ready to use.

Reconstituted solutions of ENBREL prepared with the supplied Sterile Bacteriostatic Water for Injection, USP (0.9% benzyl alcohol) must be stored in the original vial for no more than 14 days at 2°C to 8°C, with overall room temperature exposure of less than 12 hours during storage and handling. Product stability and sterility of reconstituted solutions cannot be assured after 14 days. Discard reconstituted solution after 14 days.

Keep out of the reach of children.

If you want more information about ENBREL:

- Talk to your healthcare professional
- Find the full product monograph that is prepared for healthcare professionals and includes this Patient Medication Information by visiting the [Health Canada website](#); the manufacturer's website www.amgen.ca, or by contacting the ENLIVEN[®] Services information support line, toll free at: 1-877-9ENBREL (1-877-936-2735). Additional information can be found at www.enbrel.ca.

This leaflet was prepared by AMGEN CANADA INC. for IMMUNEX CORPORATION

Last revised: March 19, 2021

©2003-2021 Amgen Canada Inc., All rights reserved.