

PRODUCT MONOGRAPH
INCLUDING PATIENT MEDICATION INFORMATION

PrNGENLA®

Somatrogon injection

24 mg/1.2 mL (20 mg/mL), pre-filled pen for subcutaneous use

60 mg/1.2 mL (50 mg/mL), pre-filled pen for subcutaneous use

recombinant DNA technology

Human Growth Hormone analogue

Pfizer Canada ULC
17,300 TransCanada Highway
Kirkland, Quebec H9J 2M5

® Pfizer Inc.
Pfizer Canada ULC, Licensee

Date of Initial Authorization:
October 26, 2021

Date of Revision:
March 28, 2023

Submission Control Number: 269082

RECENT MAJOR LABEL CHANGES

| | |
|--|---------|
| CONTRAINDICATIONS | 09/2022 |
| DOSAGE AND ADMINISTRATION | 09/2022 |
| DOSAGE FORMS, STRENGTHS, COMPOSITION AND PACKAGING | 09/2022 |
| WARNINGS AND PRECAUTIONS | 09/2022 |
| CLINICAL PHARMACOLOGY | 09/2022 |

TABLE OF CONTENTS

Sections or subsections that are not applicable at the time of authorization are not listed.

| | |
|---|-----------|
| RECENT MAJOR LABEL CHANGES | 3 |
| TABLE OF CONTENTS | 3 |
| PART I: HEALTH PROFESSIONAL INFORMATION | 5 |
| 1 INDICATIONS | 5 |
| 1.1 Pediatrics..... | 5 |
| 1.2 Geriatrics | 5 |
| 2 CONTRAINDICATIONS | 5 |
| 4 DOSAGE AND ADMINISTRATION | 6 |
| 4.1 Dosing Considerations | 6 |
| 4.2 Recommended Dose and Dosage Adjustment | 6 |
| 4.4 Administration..... | 7 |
| 4.5 Missed Dose | 7 |
| 5 OVERDOSAGE | 7 |
| 6 DOSAGE FORMS, STRENGTHS, COMPOSITION AND PACKAGING | 8 |
| 7 WARNINGS AND PRECAUTIONS | 9 |
| 7.1 Special Populations..... | 12 |
| 7.1.1 Pregnant Women | 12 |
| 7.1.2 Breast-feeding | 13 |
| 7.1.3 Pediatrics | 13 |
| 7.1.4 Geriatrics | 13 |
| 8 ADVERSE REACTIONS | 13 |
| 8.1 Adverse Reaction Overview..... | 13 |

| | | |
|--|---|-----------|
| 8.2 | Clinical Trial Adverse Reactions | 13 |
| 8.2.1 | Clinical Trial Adverse Reactions – Pediatrics | 13 |
| 8.3 | Less Common Clinical Trial Adverse Reactions | 15 |
| 8.3.1 | Less Common Clinical Trial Adverse Reactions – Pediatrics | 15 |
| 9 | DRUG INTERACTIONS | 16 |
| 9.4 | Drug-Drug Interactions | 16 |
| 9.5 | Drug-Food Interactions..... | 17 |
| 9.6 | Drug-Laboratory Test Interactions..... | 17 |
| 10 | CLINICAL PHARMACOLOGY | 17 |
| 10.1 | Mechanism of Action..... | 17 |
| 10.2 | Pharmacodynamics | 18 |
| 10.3 | Pharmacokinetics | 18 |
| 11 | STORAGE, STABILITY AND DISPOSAL | 19 |
| 12 | SPECIAL HANDLING INSTRUCTIONS | 20 |
| PART II: SCIENTIFIC INFORMATION | | 21 |
| 13 | PHARMACEUTICAL INFORMATION | 21 |
| 14 | CLINICAL TRIALS | 22 |
| 14.1 | Trial Design and Study Demographics | 22 |
| 14.2 | Study Results | 22 |
| 14.4 | Immunogenicity..... | 24 |
| 15 | MICROBIOLOGY | 24 |
| 16 | NON-CLINICAL TOXICOLOGY | 24 |
| PATIENT MEDICATION INFORMATION..... | | 27 |

PART I: HEALTH PROFESSIONAL INFORMATION

1 INDICATIONS

NGENLA (somatrogon) is indicated for:

- the long-term treatment of pediatric patients who have growth failure due to an inadequate secretion of endogenous growth hormone (growth hormone deficiency).

1.1 Pediatrics

Pediatrics (3 years old to epiphyseal fusion): The efficacy and safety of Ngenla in pediatric patients 3 to 11 years of age with growth failure due to growth hormone deficiency have been established in clinical trials. The efficacy and safety of Ngenla have not been established in patients under 3 years of age. Data on the efficacy and safety of Ngenla in patients 12 to under 18 years of age are limited. Pediatric patients with growth failure due to acquired growth hormone deficiency caused by a malignancy were not studied in clinical trials. See 14 CLINICAL TRIALS.

1.2 Geriatrics

Geriatrics: Ngenla is not indicated for use in adults. No data are available to Health Canada; therefore, Health Canada has not authorized an indication for geriatric use.

2 CONTRAINDICATIONS

- Ngenla is contraindicated in patients with closed/fused epiphyses.
- Ngenla is contraindicated in patients with active tumours and/or malignancy (see 7 WARNINGS AND PRECAUTIONS).
- Ngenla is contraindicated in patients with acute critical illness due to complications following open heart or abdominal surgery, multiple accidental trauma, or acute respiratory failure (see 7 WARNINGS AND PRECAUTIONS).
- Ngenla is contraindicated in patients who are hypersensitive to this drug or to any ingredient in the formulation, including any non-medicinal ingredient, or component of the container. For a complete listing, see 6 DOSAGE FORMS, STRENGTHS, COMPOSITION AND PACKAGING.

4 DOSAGE AND ADMINISTRATION

4.1 Dosing Considerations

- Ngenla treatment should be initiated and supervised by a physician who is experienced in the diagnosis and management of pediatric patients with growth failure due to growth hormone deficiency.
- Ngenla has not been studied in patients with renal impairment.
- Ngenla has not been studied in patients with hepatic impairment.
- Do not shake; shaking can damage the medicine.

4.2 Recommended Dose and Dosage Adjustment

The recommended dose is 0.66 mg/kg body weight administered once weekly by subcutaneous (SC) injection. For patients switching from daily growth hormone products, weekly therapy with Ngenla may be initiated at a dose of 0.66 mg/kg/week on the day following their last daily injection. Regular monitoring of Insulin-like Growth Factor-1 (IGF-1) concentrations is recommended during treatment with Ngenla.

Ngenla dosage may be adjusted as necessary based on growth velocity, body weight, and serum insulin-like growth factor 1 (IGF-1) concentrations.

Dose titration

When monitoring for IGF-1, samples should always be drawn 4 days after the prior dose. The target IGF-1 standard deviation score (SDS) should be the upper normal range not exceeding 2 SDS (see 7 WARNINGS AND PRECAUTIONS).

In patients whose blood IGF-1 concentrations exceed the mean reference value for their age and sex by more than 2 SDS, the dose of Ngenla should be reduced by 15%. More than one dose reduction may be required in some patients.

Monitor growth rate closely during the first year of Ngenla treatment. If a patient's growth rate fails to increase in the first year, assess for treatment adherence and other causes of growth failure (e.g. hypothyroidism, undernutrition, advanced bone age) and consider discontinuation of Ngenla treatment.

Treatment should be discontinued when there is evidence of closure of the epiphyseal growth plates.

4.4 Administration

Ngenla can be given in the abdomen, thighs, buttocks, or upper arms. Use a different site of injection each week.

If more than one injection is required to deliver a complete dose, administer each injection at a different injection site.

Administer Ngenla once weekly, on the same day each week, at any time of the day. The designated injection site should be prepared as instructed in the instructions for use. Always use a new sterile needle for each injection.

The pre-filled pen may be used straight from the refrigerator. For a more comfortable injection, allow up to 30 minutes for the pre-filled pen to reach room temperature (20° to 25°C).

The day of weekly administration can be changed if necessary as long as the time between 2 doses is at least 3 days (>72 hours). After selecting a new dosing day, the once weekly dosing should be continued.

If deemed appropriate, caregivers/parents can administer Ngenla to a person in their care/their child, or patients can self-inject (with caregiver/parental supervision), once they have been adequately trained by a health care professional on the use of proper subcutaneous injection technique and on the determination of the correct dose.

4.5 Missed Dose

If a dose is missed, administer Ngenla as soon as possible within 3 days after the missed dose. If more than 3 days have passed, skip the missed dose and administer the next dose on the regularly scheduled day. In each case, patients can then resume their regular once weekly dosing schedule.

5 OVERDOSAGE

Doses of Ngenla higher than 0.66 mg/kg body weight/week have not been studied.

Based on experience with daily growth hormone products, short-term overdosage could lead initially to hypoglycemia and subsequently to hyperglycemia. Long-term overdosage could result in signs and symptoms of gigantism and/or acromegaly consistent with the effects of growth hormone excess.

Treatment of overdose with Ngenla should consist of general supportive measures.

For management of a suspected drug overdose, contact your regional poison control centre.

6 DOSAGE FORMS, STRENGTHS, COMPOSITION AND PACKAGING

To help ensure the traceability of biologic products, including biosimilars, health professionals should recognize the importance of recording both the brand name and the non-proprietary (active ingredient) name as well as other product-specific identifiers such as the Drug Identification Number (DIN) and the batch/lot number of the product supplied.

Table 1 – Dosage Forms, Strengths, Composition and Packaging

| Route of Administration | Dosage Form / Strength/Composition | Non-medicinal Ingredients |
|-------------------------|--|--|
| Subcutaneous injection | Sterile solution in pre-filled pen: 24 mg somatrogon in 1.2 mL (20 mg/mL) or 60 mg somatrogon in 1.2 mL (50 mg/mL) | Citric acid monohydrate, L-Histidine, m-Cresol, Poloxamer 188, Sodium chloride, Trisodium citrate dihydrate, Water for injection |

Ngenla pre-filled pen is available in the following packages:

| | 24 mg Pre-filled Pen | 60 mg Pre-filled Pen |
|--|--|---|
| Somatrogon solution concentration | 20 mg/mL | 50 mg/mL |
| Volume | 1.2 mL | 1.2 mL |
| Color | Lilac pen cap, injection button, and label | Blue pen cap, injection button, and label |
| Dose increments | 0.2 mg/0.01 mL | 0.5 mg/0.01 mL |
| Maximum single-dose | 12 mg (0.6 mL) | 30 mg (0.6 mL) |

Somatrogon solution is a clear and colorless to slightly light yellow solution for injection with a pH of 6.6.

Each carton contains one single-patient-use, disposable pre-filled pen containing a preserved solution of somatrogon. Each pre-filled pen is capable of setting and delivering a variable dose that is determined based on patient body weight.

The medicinal product, the primary container (cartridge, bilayer disc seal, plunger stopper) and the pre-filled pen are not made with natural rubber latex.

Sterile needles are required for administration but not included. Consult the Instructions for Use document for a list of needles that can be used.

7 WARNINGS AND PRECAUTIONS

General

Acute critical illness

There is no clinical experience with Ngenla in patients with acute critical illness.

Treatment with daily growth hormone products has been associated with increased mortality in patients with acute critical illness due to complications following open heart surgery, abdominal surgery or multiple accidental trauma, or those with acute respiratory failure.

Based on experience with daily growth hormone products, if patients who are receiving Ngenla therapy become acutely critically ill, discontinuation of Ngenla should be considered (see 2 CONTRAINDICATIONS).

Myositis

Myositis is a very rare adverse event that may be related to the preservative metacresol. In the case of myalgia or disproportionate pain at injection site, myositis should be considered and if confirmed, other growth hormone products without metacresol should be used.

Carcinogenesis and Mutagenesis

Based on experience with daily growth hormone products, there is an increased risk of a second neoplasm (benign and malignant) in childhood cancer survivors. Intracranial tumours, in particular meningiomas in patients treated with radiation to the head for their first neoplasm, were the most common of the second neoplasms. However, in childhood cancer survivors, no increased risk of primary cancer recurrence has been reported in patients treated with daily growth hormone products. Patients who have achieved complete remission of malignant disease should be followed closely for relapse after commencement of Ngenla treatment. Ngenla treatment should be interrupted in case of any development or recurrence of malignant disease.

Monitor patients receiving Ngenla carefully for increased growth, or potential malignant changes, of pre-existing nevi. Advise patients/caregivers to report marked changes in behaviour, onset of headaches, vision disturbances and/or changes in skin pigmentation or changes in the appearance of pre-existing nevi.

Animal carcinogenicity studies have not been conducted for Ngenla.

Cardiovascular

Edema

Based on experience with daily growth hormone products, fluid retention (edema, arthralgia, carpal tunnel syndrome) may occur. Clinical manifestations of fluid retention are usually transient and dose-dependent.

Benign intracranial hypertension

No evidence of benign intracranial hypertension was reported in clinical trials with Ngenla.

Intracranial hypertension (IH) with papilledema, visual changes, headache, nausea, and/or vomiting has been reported in a small number of patients treated with daily growth hormone products. Symptoms usually occurred within the first 8 weeks after the initiation of daily growth hormone therapy. In all reported cases, IH-associated signs and symptoms rapidly resolved after cessation of therapy or a reduction of the daily growth hormone dose. Ngenla should be temporarily discontinued in patients with clinical or fundoscopic evidence of IH. If treatment with Ngenla is restarted, monitoring for signs and symptoms of IH is recommended.

Endocrine and Metabolism

Based on published data, patients receiving daily growth hormone therapy who have or are at risk for pituitary hormone deficiency(s) may be at risk for reduced serum cortisol levels and/or unmasking of central (secondary) hypoadrenalism. In addition, patients treated with glucocorticoid replacement for previously diagnosed hypoadrenalism may require an increase in their maintenance or stress doses following initiation of Ngenla treatment. Monitor patients for reduced serum cortisol levels and/or need for glucocorticoid dose increases in those with known hypoadrenalism (see 9 DRUG INTERACTIONS).

Glucose metabolism impairment

No clinically meaningful changes in glucose metabolism, including insulin sensitivity, were observed in clinical trials with Ngenla.

Based on experience with daily growth hormone products, treatment with Ngenla may induce a state of insulin resistance and hyperglycemia. Additional monitoring should be considered in patients treated with Ngenla who have glucose intolerance, or additional risk factors for diabetes. In patients treated with Ngenla who have diabetes mellitus, anti-diabetic therapy may require adjustment (see 9 DRUG INTERACTIONS).

Thyroid function

Based on experience with daily growth hormone products, undiagnosed/untreated hypothyroidism may prevent an optimal response to Ngenla therapy. During Ngenla therapy, thyroid function should be monitored as indicated based on clinical evaluation.

Prader-Willi syndrome

Ngenla has not been studied in patients with Prader-Willi syndrome. There have been reports of sudden death after initiating therapy with growth hormone in pediatric patients with Prader-Willi syndrome who had one or more of the following risk factors: severe obesity, history of upper airway obstruction or sleep apnea, or unidentified respiratory infection.

Immune

Injection site reactions

Patients may experience redness, swelling, pain, inflammation, or itching at the site of Ngenla injection (see 8 ADVERSE REACTIONS). Continuous rotation of the injection site may help reduce or prevent these reactions. On rare occasions, injection site reactions may require discontinuation of therapy.

Hypersensitivity

Serious systemic hypersensitivity reactions (e.g. anaphylaxis, angioedema) have been reported with daily growth hormone products. If a serious hypersensitivity reaction occurs, immediately discontinue use of Ngenla and treat promptly per standard of care and monitor until signs and symptoms resolve. Do not use in patients with previous hypersensitivity to Ngenla (see 2 CONTRAINDICATIONS).

Monitoring and Laboratory Tests

Ngenla dosage may be adjusted as necessary, based on growth velocity, body weight, and serum insulin-like growth factor 1 (IGF-1) concentrations. When monitoring for IGF-1, samples should always be drawn 4 days after the prior dose. The target IGF-1 SDS target should be the upper normal range not exceeding 2 SDS (see 4.2 Recommend Dose and Dosage Adjustment).

Somatrogon is unlikely to interfere with blood or urine pregnancy tests (see 9.7 Drug-Laboratory Test Interactions).

Musculoskeletal

Epiphyseal disorders

No epiphyseal disorders were reported with the administration of Ngenla in clinical trials. Based on the experience with daily growth hormone products, epiphyseal disorders, including slipped capital femoral epiphysis, may occur more frequently in patients with endocrine disorders or in

patients undergoing rapid growth. Any pediatric patient with the onset of a limp or complaints of hip or knee pain during treatment should be carefully evaluated.

Scoliosis

Progression of scoliosis can occur in pediatric patients who experience rapid growth. Because somatrogen increases growth rate, signs of development or progression of scoliosis should be monitored during treatment with Ngenla.

Reproductive Health: Female and Male Potential

- **Fertility**

The risk of infertility in males and females of reproductive potential has not been studied in humans.

Animal data from a fertility and early embryonic development study conducted in rats demonstrated that somatrogen administration resulted in an increase in estrous cycle length coupled with a decrease in the number of estrous cycles and an increase in the copulatory interval. A superovulatory effect (i.e., an increase in the number of corpora lutea) and increases in the number of implantations and the percentage of pre-implantation loss were also observed. The effects were observed at doses of 3, 10, and/or 30 mg/kg body weight administered by SC injection once every two days. However, there were no effects on mating, fertility, and pregnancy indices or on early embryonic development in rats (see 16 NON-CLINICAL TOXICOLOGY).

7.1 Special Populations

7.1.1 Pregnant Women

There are no studies of Ngenla use by pregnant women. Animal data from a pre- and post-natal development study conducted in rats demonstrated an increase in post-natal body weight in offspring of maternal animals administered somatrogen at doses of 10 and 30 mg/kg body weight once every two days. Reproductive assessment in the offspring also demonstrated an increase in time to mating at a maternal dose of 30 mg/kg body weight once every two days. The effects were related to maternal somatrogen administration but were considered non-adverse (see 16 NON-CLINICAL TOXICOLOGY). Animal reproduction studies are not always predictive of human response; therefore, it is unknown whether Ngenla can cause fetal harm when administered to a pregnant woman. Ngenla should be used during pregnancy only if clearly needed.

Somatrogen is unlikely to interfere with blood or urine pregnancy tests (see 9.7 Drug-Laboratory Test Interactions).

7.1.2 Breast-feeding

It is unknown if somatrogen is excreted in human milk. Precaution should be exercised because many drugs can be excreted in human milk.

7.1.3 Pediatrics

The efficacy and safety of Ngenla have been evaluated in pediatric patients aged 3 to 11 years with growth failure due to growth hormone deficiency (see 1 INDICATIONS).

7.1.4 Geriatrics

Ngenla is not indicated for use in adults. The efficacy and safety of Ngenla in geriatric patients aged 65 years of age and older have not been established (see 1 INDICATIONS).

8 ADVERSE REACTIONS

8.1 Adverse Reaction Overview

The description of adverse reactions in this section is based on clinical experience with somatrogen in a Phase 3 study (CP-4-006) in pediatric patients with GHD.

In study CP-4-006, the most common adverse reactions in pediatric patients with GHD treated with Ngenla were injection site reactions (43.1%), headache (16.5%), and pyrexia (16.5%) compared to pediatric patients with GHD receiving somatropin (25.2%, 21.7% and 13.9%, respectively)(see 7 WARNINGS AND PRECAUTIONS).

Most events of injection site pain were mild or moderate in severity for both treatment groups. Eight patients reported severe injection site pain (somatrogen: 5 patients [4.6%]; somatropin: 3 patients [2.6%]). The anatomical injection site that was most frequently associated with injection site pain for both treatment groups was the arm (left and right), and this was the site most frequently associated with severe pain events.

8.2 Clinical Trial Adverse Reactions

Clinical trials are conducted under very specific conditions. The adverse reaction rates observed in the clinical trials; therefore, may not reflect the rates observed in practice and should not be compared to the rates in the clinical trials of another drug. Adverse reaction information from clinical trials may be useful in identifying and approximating rates of adverse drug reactions in real-world use.

8.2.1 Clinical Trial Adverse Reactions – Pediatrics

The main safety data are derived from a Phase 3 safety and efficacy study (CP-4-006) in pediatric patients with growth failure due to GHD (see 14 CLINICAL TRIALS). The data reflect

exposure of 109 patients to Ngenla administered once weekly (0.66 mg somatrogon/kg body weight/week) and 115 patients to somatropin administered once daily (0.034 mg/kg body weight/day) for 12 months.

The mean age across the treatment groups was 7.7 years (min 3.0, max 12.0); 40.2% of patients were > 3 years to ≤ 7 years, 59.8% were > 7 years, 71.9% of patients were male, and 28.1% were female. In this study, 74.6% of patients were White, 20.1% were Asian, 0.9% were Black or African American, and 10.7% patients identified as Hispanic or Latino. Baseline disease characteristics were balanced across both treatment groups.

A Phase 2 study (CP-4-004) was also conducted in pediatric patients with growth failure due to GHD (See 14 CLINICAL TRIALS). The safety profile for Ngenla observed in CP-4-004 was not clinically meaningfully different from that observed in the Phase 3 study (CP-4-006).

Table 2 shows the adverse reactions that-occurred in ≥ 2% of patients treated with Ngenla. Reporting of injection site reactions was solicited through the use of a patient diary after each weekly injection for patients administered Ngenla and once weekly for patients administered daily injections of somatropin.

TABLE 2 - Adverse Reactions Reported In ≥ 2% of Pediatric Patients in the Somatrogon Group for All Causality (Baseline To Month 12)

| MedDRA System Organ Class and Preferred Term | Somatrogon (0.66 mg/kg body weight/week) (N=109) n (%) | Somatropin (0.034 mg/kg body weight/day) (N=115) n (%) |
|---|---|---|
| BLOOD AND LYMPHATIC SYSTEM DISORDERS | | |
| Anaemia | 7 (6.4) | 7 (6.1) |
| Iron deficiency anaemia | 3 (2.8) | 2 (1.7) |
| ENDOCRINE DISORDERS | | |
| Hypothyroidism | 7 (6.4) | 3 (2.6) |
| EYE DISORDERS | | |
| Conjunctivitis allergic | 3 (2.8) | 0 |
| GASTROINTESTINAL DISORDERS | | |
| Vomiting | 8 (7.3) | 9 (7.8) |
| Abdominal pain | 4 (3.7) | 2 (1.7) |
| Diarrhea | 3 (2.8) | 4 (3.5) |
| Nausea | 3 (2.8) | 1 (0.9) |
| GENERAL DISORDERS AND ADMINISTRATION SITE CONDITIONS | | |
| Injection site pain | 43 (39.4) | 29 (25.2) |
| Pyrexia | 18 (16.5) | 16 (13.9) |
| Injection site erythema | 9 (8.3) | 0 |
| Injection site pruritus | 6 (5.5) | 0 |
| Injection site swelling | 5 (4.6) | 0 |

| | | |
|--|-----------|-----------|
| Injection site induration | 4 (3.7) | 1 (0.9) |
| INFECTIONS AND INFESTATIONS | | |
| Nasopharyngitis | 25 (22.9) | 29 (25.2) |
| Pharyngitis | 7 (6.4) | 5 (4.3) |
| Rhinitis | 6 (5.5) | 1 (0.9) |
| Influenza | 5 (4.6) | 3 (2.6) |
| Tonsillitis | 5 (4.6) | 6 (5.2) |
| Enterobiasis | 4 (3.7) | 2 (1.7) |
| Gastroenteritis | 4 (3.7) | 3 (2.6) |
| Otitis externa | 4 (3.7) | 4 (3.5) |
| Otitis media | 4 (3.7) | 7 (6.1) |
| Bronchitis | 3 (2.8) | 9 (7.8) |
| Conjunctivitis | 3 (2.8) | 3 (2.6) |
| Molluscum contagiosum | 3 (2.8) | 0 |
| INJURY, POISONING AND PROCEDURAL COMPLICATIONS | | |
| Arthropod bite | 6 (5.5) | 1 (0.9) |
| INVESTIGATIONS | | |
| Free fatty acids increased | 5 (4.6) | 1 (0.9) |
| METABOLISM AND NUTRITION DISORDERS | | |
| Hypoinsulinaemia | 4 (3.7) | 3 (2.6) |
| Hypertriglyceridaemia | 3 (2.8) | 0 |
| MUSCULOSKELETAL AND CONNECTIVE TISSUE DISORDERS | | |
| Arthralgia | 5 (4.6) | 8 (7.0) |
| Pain in extremity | 5 (4.6) | 5 (4.3) |
| NERVOUS SYSTEM DISORDERS | | |
| Headache | 18 (16.5) | 25 (21.7) |
| RESPIRATORY, THORACIC AND MEDIASTINAL DISORDERS | | |
| Cough | 9 (8.3) | 9 (7.8) |
| Oropharyngeal pain | 6 (5.5) | 4 (3.5) |
| Rhinitis allergic | 3 (2.8) | 1 (0.9) |
| Rhinorrhoea | 3 (2.8) | 4 (3.5) |
| SKIN AND SUBCUTANEOUS TISSUE DISORDERS | | |
| Rash generalised | 3 (2.8) | 2 (1.7) |

8.3 Less Common Clinical Trial Adverse Reactions

8.3.1 Less Common Clinical Trial Adverse Reactions – Pediatrics

Clinical trial adverse drug reactions (Baseline to Month 12) with a frequency of less than 2% are presented in the following listing (All Causality):

Blood and Lymphatic System Disorders: Eosinophilia

Ear and Labyrinth Disorders: Ear pain

Gastrointestinal Disorders: Abdominal pain upper, Aphthous ulcer, Constipation, Dental caries, Enteritis

General Disorders and Administration Site Conditions: Fatigue, Injection site bruising, Injection site haemorrhage, Injection site warmth, pain

Infections and Infestations: Hordeolum, Pharyngitis streptococcal, Sinusitis, Viral pharyngitis, Viral upper respiratory tract infection, Otitis media acute

Injury, Poisoning and Procedural Complications: Fall, Traumatic fracture

Investigations: Blood creatine phosphokinase increased, Thyroxine free decreased

Metabolism and Nutrition Disorders: Increased appetite, Iron deficiency

Musculoskeletal and Connective Tissue Disorders: Muscle spasms

Neoplasms Benign, Malignant and Unspecified (Incl Cysts and Polyps): Skin papilloma

Nervous System Disorders: Hypoaesthesia

Psychiatric Disorders: Attention deficit/hyperactivity disorder

Respiratory, Thoracic and Mediastinal Disorders: Nasal congestion

Skin and Subcutaneous Tissue Disorders: Erythema, Rash, Urticaria

9 DRUG INTERACTIONS

9.4 Drug-Drug Interactions

Glucocorticoids

In patients receiving concomitant Ngenla and glucocorticoid treatments, glucocorticoid dosing should be carefully monitored to avoid both hypoadrenalism and an inhibitory effect on growth.

The microsomal enzyme 11 β -hydroxysteroid dehydrogenase type 1 (11 β HSD-1) is required for conversion of cortisone to its active metabolite, cortisol, in hepatic and adipose tissue.

Treatment with daily growth hormone products inhibits 11 β HSD-1, reducing serum cortisol concentrations, which may unmask previously undiagnosed central (secondary) hypoadrenalism or render low glucocorticoid replacement doses ineffective (see 7 WARNINGS AND PRECAUTIONS).

Patients treated with cortisone acetate and prednisone may be affected more than others because conversion of these drugs to their biologically active metabolites is dependent on the activity of 11 β HSD-1.

Insulin and/or oral/injectable hypoglycemic agents

In patients with diabetes mellitus requiring drug therapy, the dose of insulin and/or oral/injectable agent may require adjustment when Ngenla therapy is initiated (see 7 WARNINGS AND PRECAUTIONS).

Limited published data indicate that growth hormone treatment, increases cytochrome P450 (CP450) mediated antipyrine clearance in human. Somatrogen may also increase CYP3A4. These data suggest that growth hormone administration may alter the clearance of compounds known to be metabolized by CP450 liver enzymes (e.g. corticosteroids, sex steroids, anticonvulsants, cyclosporine). Careful monitoring is advisable when somatrogen is administered in combination with other drugs known to be metabolized by CP450 liver enzymes.

9.5 Drug-Food Interactions

Interactions with food have not been established.

9.6 Drug-Herb Interactions

Interactions with herbal products have not been established.

9.7 Drug-Laboratory Test Interactions

Interactions with laboratory tests have not been established. Somatrogen contains a CTP domain derived from human chorionic gonadotropin (hCG). In *in vitro* testing, urine and blood samples spiked with somatrogen did not interfere with commercial pregnancy test kits. However, serum somatrogen levels in pediatric patients treated with 0.66 mg/kg somatrogen reach higher levels than those tested in the study. While it is unlikely that somatrogen would interfere with pregnancy tests, the potential for interference cannot be ruled out. If pregnancy is suspected, it is recommended that testing be conducted prior to somatrogen dosing to reduce the risk of interference of high serum somatrogen.

10 CLINICAL PHARMACOLOGY

10.1 Mechanism of Action

Somatrogen binds to the growth hormone (GH) receptor and initiates a signal transduction cascade culminating in changes in growth and metabolism. Consistent with GH signaling, somatrogen binding leads to activation of the STAT5b signaling pathway and induces cell proliferation *in vitro*. Somatrogen has also been shown to increase the serum concentration of insulin-like growth factor (IGF-1).

10.2 Pharmacodynamics

Somatrogen increases IGF-1. Pharmacodynamic evaluations were performed approximately 96 hours after dose administration in order to assess the mean IGF-1 SDS over the weekly dosing interval (see Figure 1).

Figure 1. Observed IGF-1 SDS profiles in pediatric patients with GHD during 12 months of treatment with somatrogen

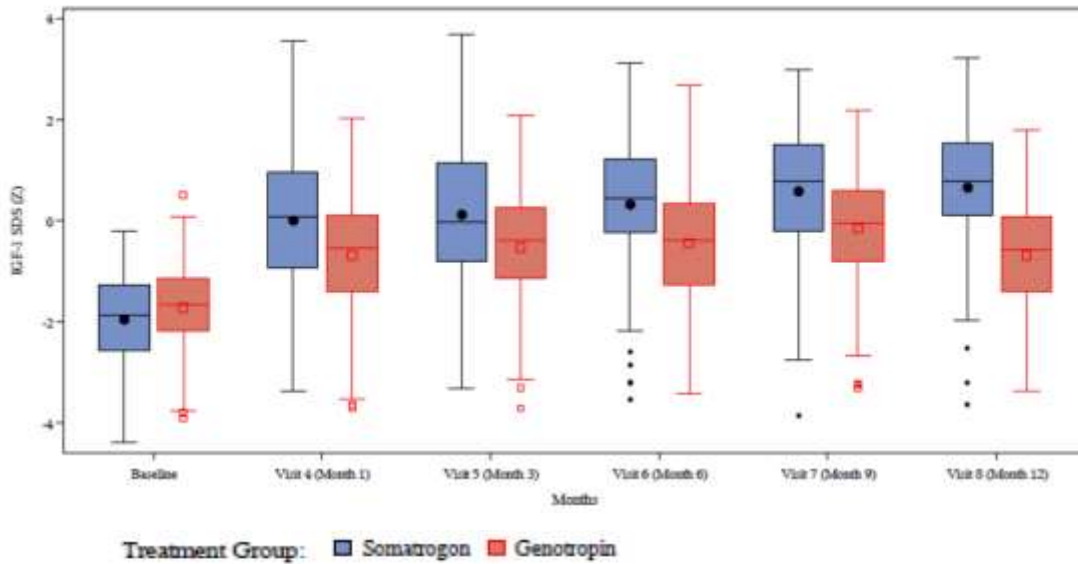

| | Baseline | Visit 4 (Month 1) | Visit 5 (Month 3) | Visit 6 (Month 6) | Visit 7 (Month 9) | Visit 8 (Month 12) |
|------------|----------|-------------------|-------------------|-------------------|-------------------|--------------------|
| Treatment | N | N | N | N | N | N |
| Somatrogen | 109 | 107 | 109 | 107 | 100 | 107 |
| Genotropin | 115 | 115 | 113 | 113 | 113 | 110 |

Observed data are from study CP-4-006 in pediatric GHD patients aged 3-12 years (see 14 CLINICAL TRIALS). SDS values were calculated using age- and sex-adjusted reference values.

10.3 Pharmacokinetics

Table 3 - Summary of Simulated Steady State Somatrogen PK in Pediatric Patients receiving 0.66 mg/kg/week Somatrogen

| | Cmax (ng/mL) | Tmax (h) | T1/2 (h) | AUC (ng.h/mL) | CL (L/h/kg) | Vd (L/kg) |
|---------------------------|--------------|----------|----------|---------------|-------------|---|
| 0.66 mg/kg/wk dose | 690 | 8 | 28.3 | 21800 | 0.0336 | 0.812 (central volume) 0.169 (peripheral volume) |

Somatrogon pharmacokinetics (PK) were assessed using a population PK approach for Ngenla in 42 pediatric patients with growth hormone deficiency.

Absorption

Following SC injection, serum concentrations increased slowly, peaking 6 to 18 hours after dosing.

In pediatric patients with GHD, somatrogon exposure increases in a dose-proportional manner for doses of 0.25 mg/kg/week, 0.48 mg/kg/week and 0.66 mg/kg/week. There is no accumulation of somatrogon after once weekly administration. In pediatric patients with GHD, the mean population PK estimated steady-state peak concentrations following 0.66 mg/kg/week was 690 ng/mL.

Distribution

In pediatric patients with GHD, the mean population PK estimated apparent central volume of distribution was 0.812 L/kg and apparent peripheral volume of distribution was 0.169 L/kg.

Metabolism

The metabolic fate of somatrogon is believed to be classical protein catabolism, with subsequent reclamation of the amino acids and return to the systemic circulation.

Elimination

In pediatric patients with GHD, the mean population PK estimated apparent clearance was 0.0336 L/h/kg. With a mean population PK estimated effective half-life of 28.3 hours, somatrogon will be present in the circulation for about 6 days after the last dose.

Special Populations and Conditions

Based on population PK analyses, age (≤ 6 years or 6–<12 years) and sex do not have a clinically meaningful effect on the pharmacokinetics of somatrogon in pediatric patients with GHD. The exposure of somatrogon decreases with an increase in body weight. The somatrogon dosing regimen of 0.66 mg/kg/week provided adequate systemic exposure over the body weight range of 10 to 54 kg evaluated in the clinical studies.

- **Hepatic Insufficiency:** Ngenla has not been studied in patients with hepatic impairment.
- **Renal Insufficiency:** Ngenla has not been studied in patients with renal impairment.

11 STORAGE, STABILITY AND DISPOSAL

Store Ngenla pre-filled pen in a refrigerator (2°C to 8°C). DO NOT FREEZE. Do not use beyond the expiration date stamped on the carton. Before first use keep the pre-filled pen in its outer carton in order to protect from light.

A single pre-filled pen stored at 2°C to 8°C may be used for a single period of up to 28 days from the date of first use when stored at 2°C to 8°C in between each use. For a more comfortable injection, the pre-filled pen may be exposed to room temperature (no more than 32°C) for a maximum of 2 hours prior to injection. Store away from direct sunlight. The same pre-filled pen can be used for a maximum of 5 times during the in-use period of 28 days.

Always remove and safely discard the needle after each injection and store the Ngenla pre-filled pen without an injection needle attached. Always use a new needle for each injection. Replace the cap on your pre-filled pen when it is not in use. Store the pre-filled pen at 2°C to 8°C in between each use.

Any unused product or waste material should be disposed of in accordance with local requirements. If your pre-filled pen is empty, has been left out of the refrigerator (up to 32°C) for more than 2 hours with each use, has been exposed to temperatures above 32°C, has been used 5 times, or it has been more than 28 days after first use, throw it away even if it contains unused medicine.

12 SPECIAL HANDLING INSTRUCTIONS

Each Ngenla pre-filled pen is for use by a single patient. An Ngenla pre-filled pen must never be shared between patients, even if the needle is changed.

Do not inject the medicine if it is cloudy or dark yellow. Do not shake; shaking can damage the medicine.

PART II: SCIENTIFIC INFORMATION

13 PHARMACEUTICAL INFORMATION

Drug Substance

Proper name: Somatrogon

Chemical name:

| | |
|---------------|---|
| Molecule Type | O-Glycosylated Fusion Protein (CTP-hGH-CTP-CTP) |
| Cell Line | Chinese Hamster Ovary (CHO) |

CTP = C-terminal peptide; hGH = human growth hormone

Molecular formula and molecular mass:

| O-Linked Glycoform | Theoretical Mass (Da) | Molecular Formula |
|--|-----------------------|--|
| Aglycosylated | 30465.1 | C ₁₃₅₉ H ₂₁₂₅ N ₃₆₁ O ₄₂₀ S ₇ |
| 15 O-glycans, core-1 monosialylated (GalNAc-Gal-NeuAc) | 40313.9 | C ₁₇₃₄ H ₂₇₂₅ N ₃₉₁ O ₆₉₀ S ₇ |
| 16 O-glycans, core-1 monosialylated (GalNAc-Gal-NeuAc) | 40970.5 | C ₁₇₅₉ H ₂₇₆₅ N ₃₉₃ O ₇₀₈ S ₇ |

Structural formula:

```
1  SSSSKAPPPSLPSPSRRLPGPSDTPILPQFFPTIPLSRLFDNAMLRAHRLHQLAFDITYQEFE 60
61  EAYIPKEQKYSFLQNPQTSLCFSESIPTPSNREETQQKSNLELLRISLLLIQSWLEPVQF 120
121  LRSVFNANSLVYGASDSNVYDLLKDLLEGIQTLMGRLEDGSPRTGQIFKQTYSKFDTNSHN 180
181  DDALLKNYGLLYCFRDKMDKVETFLRIVQCRSVEGSCGFSSSSKAPPPSLPSPSRRLPGPS 240
241  DTPILPQSSSSKAPPPSLPSPSRRLPGPSDTPILPQ 275
```

Somatrogon amino acid sequence; residues are numbered sequentially starting with the N terminus. The confirmed disulfide bonds are illustrated with connecting lines. The functional, intact molecule is composed of recombinant hGH and one copy of CTP from the beta chain of hCG at the N-terminus (bold amino acids [1-28]) and two copies of CTP (in tandem) at the C-terminus (bold amino acids [220-247], and [248-275]).

Physicochemical properties: Somatrogon has a pH of approximately 6.6 and is a clear and colorless to slightly light yellow solution.

Product Characteristics:

Somatrogon is a glycoprotein produced in Chinese Hamster Ovary (CHO) cells by recombinant DNA technology. It is comprised of the amino acid sequence of human growth hormone (hGH) with one copy of the of C-terminal peptide (CTP) from the beta chain of human chorionic gonadotropin (hCG) at the N-terminus and two copies of CTP (in tandem) at the C-terminus. The glycosylation and CTP domains account for the half-life of somatrogon, which allows for weekly dosing.

14 CLINICAL TRIALS

14.1 Trial Design and Study Demographics

Table 4 - Summary of patient demographics for clinical trial in pediatric growth hormone deficiency

| Study # | Trial design | Dosage, route of administration and duration | Study patients (n) | Mean age (Range) | Sex |
|----------|---|--|---|---------------------------|-----------------|
| CP-4-004 | Phase 2, Open-label Randomized Active-controlled Multicenter Parallel-group | Somatrogon 0.25 mg/kg body weight weekly, Somatrogon 0.48 mg/kg body weight weekly, Somatrogon 0.66 mg/kg body weight weekly, Somatropin 0.034 mg/kg body weight daily 12 months (main study) 5 years (OLE) | n = 53 (main study) n = 48 (entered OLE) | 6.4 years (3.0, 11.2). | Female and Male |
| CP-4-006 | Open-label Randomized Active-controlled Multicenter Parallel-group | Somatrogon 0.66 mg/kg body weight weekly, somatropin 0.034 mg/kg body weight daily Subcutaneous Injections 12 months | n = 224 somatrogon (n=109) somatropin (n=115) | 7.7 years (3.0, 12.0) | Female and Male |

14.2 Study Results

The efficacy and safety of Ngenla for the treatment of pediatric patients with GHD were evaluated in two multi-center randomized, open-label controlled clinical studies, CP-4-004 and CP-4-006.

CP-4-004 was an open-label, randomized, safety and dose-finding study that enrolled 53 pre-pubertal pediatric patients aged 3-11 years with growth failure due to GHD and who were naïve to growth hormone therapy. Patients were randomized to be treated with one of 3 doses of once weekly subcutaneous Ngenla (0.25 mg/kg body weight/week [N=13], 0.48 mg/kg body weight/week [N=15], 0.66 mg/kg body weight/week [N=14]) or subcutaneous somatropin administered once daily (0.034 mg/kg body weight/day [N=11]). Overall, 60% of patients were male, 96% were white, 0% were Asian, 2% were Black or African American, and 2% were 'Other'. At baseline, mean (min, max) age was 6.4 (3.0, 11.2) years; 64.2% of patients were aged 3-6 and 35.8 % were 7 years and older. Mean (min, max) height was 101.5 (81.5, 127.5) cm and mean height standard deviation score (SDS; min, max) was -4.0 (-7.5, -2.3). After 12 months, annualized height velocity was 11.4 cm/year in patients treated with 0.66 mg/kg body weight/week of Ngenla and was 12.5 cm/year in patients treated with somatropin. In the open-label extension of CP-4-004, continued increases in height were observed in 35 of the 53

patients who had completed the main study and were treated with 0.66 mg/kg body weight/week Ngenla for at least five years.

CP-4-006 was an open-label, randomized, multicenter safety and efficacy study that enrolled in 224 pre-pubertal pediatric patients aged 3-11 years with growth failure due to GHD who were naïve to growth hormone therapy. The objective of the study was to determine whether treatment with Ngenla was non-inferior to treatment with somatropin for the primary efficacy endpoint of height velocity (cm/year) at 12 months. Patients were randomized and treated for one year with once weekly subcutaneous Ngenla (N=109) at a dose of 0.66 mg/kg body weight/week or once daily subcutaneous somatropin (N=115) at a dose of 0.034 mg/kg body weight/day. Overall, 72% of patients were male, 75% were white, 20% were Asian, 1% were Black or African American, and 11% were Hispanic or Latino. At baseline, mean (min, max) age was 7.72 (3.01, 11.96) years; 40% of patients were aged 3-6 and 60% were 7 years and older. Mean (min, max) height was 110 (75, 144) cm and mean height standard deviation score (SDS; min, max) was -2.86 (-9.96, -0.47).

After 12 months, treatment with Ngenla once weekly resulted in a mean increase in height velocity that met the pre-specified non-inferiority margin of -1.8 cm/year. See Table 5 for the main efficacy findings.

Table 5 - Efficacy of Ngenla compared to somatropin in pediatric patients with growth failure due to GHD at Month 12

| Treatment Parameter | Treatment Group | | Difference in Treatment |
|--|---------------------|---------------------|------------------------------------|
| | Ngenla (N=109) | Somatropin (N=115) | Ngenla - Somatropin |
| ANCOVA | LSM Estimate | LSM Estimate | LSM Difference (95% CI) |
| <u>Primary endpoint</u> | | | |
| Height Velocity (cm/year) at 12 months | 10.10 | 9.78 | 0.33 (-0.24, 0.89)* |
| <u>Secondary endpoints</u> | | | |
| Height Standard Deviation Score at 12 months | -1.94 | -1.99 | 0.05 (-0.06, 0.16) |
| Change in Height Standard Deviation Score from baseline at 12 months | 0.92 | 0.87 | 0.05 (-0.06, 0.16) |

Abbreviations: CI=confidence interval; GHD=growth hormone deficiency; LSM=least square mean; N=number of patients randomized and treated

*The 95% CIs were obtained from the analysis of covariance (ANCOVA) model with treatment as the main effect, age group, gender and peak GH levels as the covariates. Non-inferiority will be concluded if the lower bound of the two-sided 95% CI is ≥ -1.8

14.4 Immunogenicity

Consistent with the potentially immunogenic properties of protein and peptide pharmaceuticals, patients treated with Ngenla may develop antibodies to somatrogen.

The detection of antibody formation is highly dependent on the sensitivity and specificity of the assay. Additionally, the observed incidence of antibody (including neutralizing antibody) positivity in an assay may be influenced by several factors including assay methodology, sample handling, timing of sample collection, concomitant medications, and underlying disease. For these reasons, comparison of the incidence of antibodies to somatrogen in the studies described below with the incidence of antibodies in other studies or to other products may be misleading.

In the Phase 2 study CP-4-004, anti-drug antibodies (ADAs) were reported in 24% (N=10/42) of Ngenla-treated subjects during the first 12 months of treatment. No neutralizing antibodies were reported in these subjects.

In study CP-4-006, ADAs were reported in 77% (N=84/109) of Ngenla-treated subjects during the first 12 months of treatment. Of these, 2/84 (2.4%) tested positive for neutralizing antibodies.

15 MICROBIOLOGY

No microbiological information is required for this drug product.

16 NON-CLINICAL TOXICOLOGY

General Toxicology: Somatrogen has been evaluated in repeat-dose toxicity studies in rats and rhesus monkeys, using the subcutaneous route of administration.

A 4-week study in adult rats was conducted at doses of 3.6, 36, and 180 mg/kg administered twice weekly (exposures of 4.1, 69, and 301 times [based on AUC] the human exposure at the maximum recommended dose of 0.66 mg/kg once weekly, respectively). Anticipated increases in body weight, body weight gain, and food consumption were observed, which were attributed to the pharmacodynamic growth hormone effect of somatrogen. Other findings related to the pharmacological activity of somatrogen, either directly or indirectly, occurred in mammary glands, liver, kidney, and spleen in rats. These findings included mammary gland feminization in males (all doses), mammary gland lobular hyperplasia in females (≥ 36 mg/kg), periportal vacuolation in the liver (all doses), increased incidence of renal tubular mineralization in females (180 mg/kg), increased extramedullary haematopoiesis in the spleen in males (180 mg/kg), and slight anaemia (≥ 36 mg/kg).

Studies in rhesus monkeys consisted of a 4-week study conducted at doses of 1.8, 18, and 90 mg/kg administered once every 6 days (exposures of 4.3, 40, and 219 times [based on AUC] the

human exposure, respectively) and a 26-week study in mainly juvenile animals conducted at doses of 1.5, 15, and 30 mg/kg administered once every 5 days (exposures of 9, 81, and 193 times [based on AUC] the human exposure, respectively). In both studies, an increase in serum IGF-1 levels was observed at all doses, which was attributed to secondary effects of somatrogon. No adverse effects were observed, including on cardiovascular function. Based on the results of the 26-week study, the no-observed-adverse-effect level (NOAEL) for the general toxicity of somatrogon in rhesus monkeys was 30 mg/kg administered subcutaneously once every 5 days (the highest dose tested).

Carcinogenicity: Carcinogenicity studies have not been performed with somatrogon.

Genotoxicity: Genotoxicity studies have not been performed with somatrogon.

Reproductive and Developmental Toxicology:

The potential for somatrogon to have effects on fertility and early embryonic development was evaluated in male and female rats following administration via SC injection at doses of 3, 10, and 30 mg/kg. Females were dosed starting from 2 weeks prior to cohabitation until gestation day (GD) 7 and males were dosed starting from 4 weeks prior to cohabitation to GD 13 in females. Somatrogon elicited an increase in estrous cycle length (≥ 10 mg/kg) coupled with a decrease in the number of estrous cycles (all doses) and an increase in the copulatory interval (≥ 10 mg/kg). Somatrogon administration also resulted in increases in the number of corpora lutea, number of implantations, and in the percentage of pre-implantation loss at 10 mg/kg and/or 30 mg/kg, but there was no impact on mating, fertility, and pregnancy indices or on the number of viable embryos per dam and early embryonic development. The NOAEL for the effects of somatrogon on fertility and early embryonic development in rats was therefore 30 mg/kg administered subcutaneously once every two days (the highest dose tested).

An embryo-fetal development study was also conducted in rats administered somatrogon via SC injection at doses of 3, 10, or 30 mg/kg every two days from GD 6 to 18 exposures of 4, 12, and 51 times [based on AUC; GD 6] the human exposure at the maximum recommended human dose, respectively). Somatrogon elicited pharmacologically-mediated, non-adverse, increases in maternal body weights and body weight gain at all doses and in food consumption at doses ≥ 10 mg/kg. However, there were no adverse maternal or embryo-fetal effects. Thus, the NOAEL for the maternal and developmental toxicity of somatrogon in pregnant rats in this study was 30 mg/kg body weight administered subcutaneously once every two days (the highest dose tested).

The potential for effects of somatrogon on development was also evaluated in a pre- and postnatal development study in rats in which somatrogon was administered via SC injection to pregnant rats every 2 days from GD 6 to Lactation Day 20 at doses of 3, 10, and 30 mg/kg. There was no evidence of maternal toxicity and no adverse developmental effects on the first generation (F1) offspring. Somatrogon elicited an increase in F1 mean body weights (both sexes), as well as an increase in the mean copulatory interval in F1 females at the highest dose

(30 mg/kg), following cohabitation with F1 males; however, there were no associated effects on mating, fertility, or pregnancy indices. Thus the NOAEL for the maternal and developmental toxicity of somatogon in pregnant rats in this study was 30 mg/kg body weight administered subcutaneously once every two days (the highest dose tested).

PATIENT MEDICATION INFORMATION

READ THIS FOR SAFE AND EFFECTIVE USE OF YOUR MEDICINE

PrNGENLA®

Somatrogon Injection

Read this carefully before your child starts taking Ngenla and each time your child gets a refill. This leaflet is a summary and will not tell you everything about this drug. Talk to your healthcare professional about your child's medical condition and treatment and ask if there is any new information about Ngenla.

What is Ngenla used for?

Ngenla is used for the long-term treatment of children who are not growing because of low growth hormone levels.

How does Ngenla work?

Ngenla helps your child's bones and muscles to grow and also helps your child's fat and muscle tissues to develop in the right amounts. It is a modified form of human growth hormone which allows weekly dosing.

What are the ingredients in Ngenla?

Medicinal ingredients: somatrogon

Non-medicinal ingredients: citric acid monohydrate, L-Histidine, m-Cresol, poloxamer 188, sodium chloride, trisodium citrate dihydrate, water for injection

Ngenla comes in the following dosage forms:

Single-patient use pre-filled pen containing:

- 24 mg of somatrogon in 1.2 mL (20 mg/mL); or
- 60 mg of somatrogon in 1.2 mL (50 mg/mL)

Do not use Ngenla if:

- your child is allergic to somatrogon or any of the ingredients in Ngenla (see **What are the ingredients in Ngenla?** section).
- your child has an active tumour and/or malignancy
- your child is seriously ill due to complications following:
 - open heart surgery,
 - abdominal surgery,
 - multiple accidental trauma, or
 - acute respiratory failure
- Your child's bones have already finished growing (this is called closure of the growth plates).

To help avoid side effects and ensure proper use, talk to your child's healthcare professional before your child takes Ngenla. Talk about any health conditions or problems your child may have, including if your child:

- develops visual changes, headache, big change in behaviour, nausea and/or vomiting.
- is being treated with daily growth hormone therapy or is treated with glucocorticoid replacement. Your child's doctor should monitor your child's cortisol levels.
- is being treated with thyroid hormones. Your child's doctor should monitor your child's thyroid function.
- has diabetes. You should closely monitor your child's blood sugar level during treatment with Ngenla. Discuss the results with your child's doctor to determine if there is a need to change the dose of your child's medicines to treat diabetes.
- starts to limp while being treated with Ngenla.
- has changes in skin color or in the appearance of birthmarks or moles on the skin.
- has pain in their hip or knee.
- is pregnant or could become pregnant. Ngenla contains components that might interact with pregnancy tests. If your child needs to take a pregnancy test, it should be done before your child's injection to reduce the risk of interference.
- is breast-feeding or plans to breast-feed.
- has signs of scoliosis
- has ever had any kind of tumour.
- has Prader-Willi syndrome. There have been reports of sudden deaths in children with Prader-Willi syndrome who were treated with growth hormone and had one or more of the following risk factors: severe obesity, breathing problems, colds or lung infections.

Tell your child's healthcare professional about all the medicines your child takes, including any drugs, vitamins, minerals, natural supplements or alternative medicines.

The following may interact with Ngenla:

- medicines used to treat diabetes.
- glucocorticoid treatments such as cortisone and prednisone.
- sex hormones (for example oral estrogens).
- cyclosporine (a medicine that weakens the immune system after transplantation).
- medicines to control epilepsy (anticonvulsants).

How to take Ngenla:

Your child's healthcare professional will show you how to inject Ngenla before using it for the first time. Do NOT try to inject Ngenla until you have been shown the right way by your child's healthcare professional.

Ngenla is injected under the skin (subcutaneously) and can be given in the stomach (abdomen), thighs, buttocks or upper arms. Use a different injection site every week.

If your child needs more than one injection for a full dose, each one should be given at a different injection site.

Use Ngenla once weekly, on the same day each week, at any time of the day.

You may change the day of the week your child uses Ngenla as long as the last dose was given 3 or more days before. After selecting a new day, the once weekly dosing should be continued.

Ngenla pre-filled pens are for use by 1 person only.

Do NOT share your child's Ngenla pre-filled pens and needles with another person, even if the needle has been changed. Your child may give another person an infection or get an infection from them.

Do NOT shake your child's pen; shaking can damage the medicine.

Usual dose:

The recommended dose is 0.66 mg/kg body weight injected once weekly. Your child's healthcare professional will prescribe the dose of medicine that is right for your child. Your child's doctor may perform regular blood tests to check how your child is responding to the treatment. Their dose may be changed according to blood test results, as necessary.

Overdose:

If you think your child, or a person you are caring for, has taken too much Ngenla, contact a healthcare professional, hospital emergency department, or regional poison control centre immediately, even if there are no symptoms.

Missed Dose:

If your child misses a dose of Ngenla, take the missed dose as soon as possible within 3 days of the missed dose. If more than 3 days have passed, skip the missed dose and give your child the next dose on the regularly scheduled day.

What are possible side effects from using Ngenla?

These are not all the possible side effects your child may have when taking Ngenla. If your child experiences any side effects not listed here, tell your child's healthcare professional.

Side effects may include:

Very common (may affect more than 1 in 10 people)

- injection site reactions including pain, redness, itching, swelling and/or local thickening of the skin
- fever

Common

- cold

- headache

| Serious side effects and what to do about them | | | |
|---|--------------------------------------|--------------|---|
| Symptom / effect | Talk to your healthcare professional | | Stop taking drug and get immediate medical help |
| | Only if severe | In all cases | |
| VERY COMMON | | | |
| Respiratory tract infections: Cough; sneezing; nasal congestion; runny nose; fever; scratchy or sore throat. | ✓ | | |
| Skin infections: Redness of the skin and a rash; itching, pain, and tenderness. | ✓ | | |
| COMMON | | | |
| Ear infections: Ear pain; fever; drainage from the ear that is thick and yellow or bloody; loss of appetite, vomiting, and grumpy behavior; trouble sleeping. | ✓ | | |
| Infection in the small intestine: Gas, bloating, diarrhea, abdominal pain or cramping; constipation. | ✓ | | |
| Pain or stiffness in the joints: stiffness in the arms and legs; joint pain; muscle pain | ✓ | | |
| Worsening of curvature of the spine (scoliosis): Back pain; one shoulder blade is higher than the other; one shoulder blade sticks out more than the other; uneven hips. | ✓ | | |
| UNCOMMON | | | |
| Serious allergic reactions: swelling of the face, lips, mouth, or tongue; trouble breathing; wheezing; severe itching; skin rashes, redness, or swelling; dizziness or fainting; fast heartbeat or pounding the chest; sweating. | | | ✓ |

If your child has a troublesome symptom or side effect that is not listed here or becomes bad enough to interfere with your child's daily activities, tell your child's healthcare professional.

Reporting Side Effects

You can report any suspected side effects associated with the use of health products to Health Canada by:

- Visiting the Web page on Adverse Reaction Reporting (<https://www.canada.ca/en/health-canada/services/drugs-health-products/medeffect-canada.html>) for information on how to report online, by mail or by fax; or
- Calling toll-free at 1-866-234-2345.

NOTE: Contact your health professional if you need information about how to manage your side effects. The Canada Vigilance Program does not provide medical advice.

Storage:

Prior to each use the pen can be left at room temperature for a more comfortable injection, not more than 32 °C for a maximum 2 hours. Do NOT use beyond the expiration date stamped on the carton.

Before first use (unused pre-filled pens):

- Store your child's Ngenla pens in the refrigerator between 2°C to 8°C and in the original carton and away from direct sunlight.
- Do NOT freeze your child's pen or expose it to heat.
- Unused pre-filled pens may be used until the expiration date printed on the carton, if kept in the refrigerator.

After first use (up to 28 days of use):

- To help you remember when to dispose of your child's Ngenla pen, you can write the date of first use on the pen label.
- Store your child's pen in the refrigerator at 2°C to 8°C in between each use and away from direct sunlight.
- Do NOT freeze your child's pen or expose it to heat.
- Always remove and safely discard the needle after each injection. Do NOT store the pen with a needle attached.
- Always use a new needle for each injection.
- Keep the pen cap on your child's pen when it is not in use.
- Discard your child's pen when:
 - the pen is empty or, has been used 5 times,
 - the pen has been left out of the refrigerator (up to 32°C) for more than 2 hours with each use,
 - the pen has been exposed to temperatures above 32°C; or
 - it has been **more than 28 days** after first use, discard it even if it contains unused medicine.

Any unused product or waste material should be disposed of in accordance with local requirements.

When travelling, transport your child's Ngenla pen in its original carton in an insulated container with an ice pack. To avoid freezing, make sure your child's pen does not touch the ice pack. Once you arrive, your child's pen should be placed in a refrigerator as soon as possible. Do NOT leave it in a car or other place where it can get too hot or too cold.

Keep out of reach and sight of children.

If you want more information about Ngenla:

- Talk to your child's healthcare professional
- Find the full product monograph that is prepared for healthcare professionals and includes this Patient Medication Information by visiting the Health Canada website: (<https://www.canada.ca/en/health-canada/services/drugs-health-products/drug-products/drug-product-database.html>); the manufacturer's website <http://www.pfizer.ca>, or by calling Pfizer Canada ULC at 1-800-463-6001.

This leaflet was prepared by Pfizer Canada ULC.

Last Revised March 28, 2023

NGENLA®

Somatrogon Injection

24 mg/1.2 mL (20 mg/mL), pre-filled pen for subcutaneous injection

INSTRUCTIONS FOR USE (IFU)

Injection for subcutaneous (under the skin) use only

Keep this leaflet. These instructions show step-by-step directions on how to prepare and give an injection.

Important information about your child's Ngenla pen

- Ngenla for injection is a single-patient use, disposable (throw away) pre-filled pen containing 24 mg of medicine. You can give more than 1 dose from the pen.
- Ngenla for injection can be given by a patient, caregiver or healthcare provider. **Do NOT** try to inject Ngenla yourself until you are shown the right way to give the injections and read and understand the Instructions for Use. If your child's healthcare provider decides that you may be able to give your child's injections of Ngenla at home, you should receive training on the right way to prepare and inject Ngenla. It is important that you read, understand, and follow these instructions so that you inject Ngenla the right way.
- It is important to talk to your child's healthcare provider to be sure you understand your child's Ngenla dosing instructions. To help you remember when to inject Ngenla, you can mark your calendar ahead of time. Call your child's healthcare provider if you have any questions about the right way to inject Ngenla, or by calling Pfizer Canada ULC at 1-800-463-6001.
- **Do NOT** share your child's pen with other people, even if the needle has been changed. Your child may give other people a serious infection, or get a serious infection from them.
- Each turn (click) of the dose knob has 0.2 mg of medicine. You can give from 0.2 mg to 12 mg in a single injection. If your child's dose is more than 12 mg, you will need to give more than 1 injection.
- A new pen may contain slightly more than 24 mg of medicine, this is normal.
- Always use a new sterile needle for each injection. This will reduce the risk of contamination, infection, leakage of medicine, and blocked needles leading to the wrong dose.
- **Do NOT** shake your child's pen. Shaking can damage the medicine.
- The pen is **NOT recommended** for use by the blind or visually impaired without the assistance of a person trained in the proper use of the product.

Supplies you will need each time you inject

Included in the carton:

- 1 Ngenla pre-filled pen.

Not included in the carton:

- 1 new sterile needle for each injection
- Alcohol swabs
- Cotton balls or gauze pads
- Adhesive bandage
- 1 appropriate “sharps” disposal container for disposal of pen needles and pens (See How should I dispose of the pen needles and pens?)

24 mg NGENLA pen:

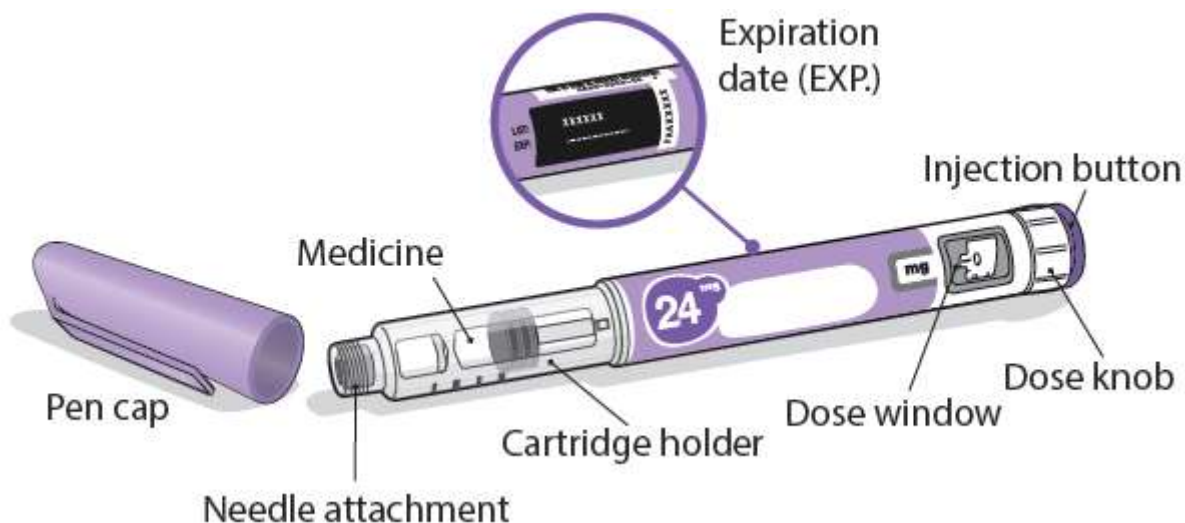

Needles to use

Pen needles are **not included** with your child’s Ngenla pen. You will need a prescription from your child’s healthcare provider to get pen needles up to a length of 8 mm from your pharmacy.

- Needles to use with your child’s Ngenla pen:
 - 32G or 31G (Novo Nordisk®)
 - 31G (Becton Dickinson and Company)
- Talk with your child’s healthcare provider about the right needle for your child.

Sterile needle (example) not supplied:

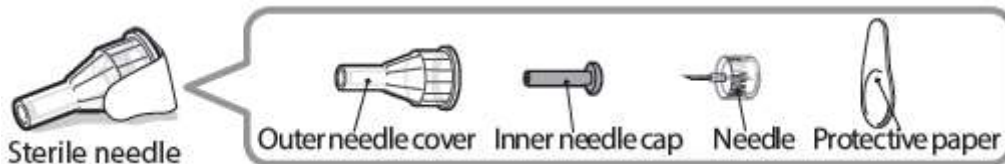

Caution: Never use a bent or damaged needle. Always handle pen needles with care to make sure you do not prick yourself (or anyone else) with the needle. **Do NOT** attach a new needle to your child's pen until you are ready to give the injection.

Prior to each use the pen can be left at room temperature for a more comfortable injection, not more than 32 °C for a maximum 2 hours. Do NOT use beyond the expiration date stamped on the carton.

Preparing for your child's injection

Step 1 - Getting ready

- Wash and dry your hands.
- You can use your child's pen straight from the refrigerator. For a more comfortable injection, leave your child's pen at room temperature for up to 30 minutes.
- Check the name, strength, and label of your child's pen to make sure it is the medicine your child's healthcare provider has prescribed for your child.
- Check the expiration date on the pen label. **Do NOT** use if the expiration date has passed.
- **Do NOT** use your child's pen if:
 - it has been frozen or exposed to heat.
 - it has been dropped.
 - it looks broken or damaged.
 - it has been more than 28 days after first use of the pen.
 - It has been used 5 times.
 - It has been left out of the refrigerator (up to 32°C) for more than 2 hours with each use.
 - It has been exposed to temperatures above 32°C
- **Do NOT** remove the pen cap from your child's pen - until you are ready to inject.

Step 2 - Choose and clean your child's injection site



- Ngenla can be given in the abdomen, thighs, buttocks, or upper arms.
- Choose the best place to inject, as recommended by your child's healthcare provider.
- If more than 1 injection is needed to complete your child's full dose, each injection should be given in a different injection site.
- **Do NOT** inject into bony areas, areas that are bruised, red, sore or hard, and areas that have scars or skin conditions.
- Clean the injection site with an alcohol swab.
- Allow the injection site to dry.
- **Do NOT** touch injection site after cleaning.

Step 3 - Check medicine



- Pull off the pen cap and keep it for after your child's injection.
- Check the medicine inside the cartridge holder.
- Make sure the medicine is clear and colorless to slightly light yellow. **Do NOT** inject the medicine if it is cloudy or dark yellow.
- Make sure the medicine is free of flakes or particles. **Do NOT** inject the medicine if it has flakes or particles.
- **Note:** It is normal to see one or more bubbles in the medicine.

Step 4 - Attach needle

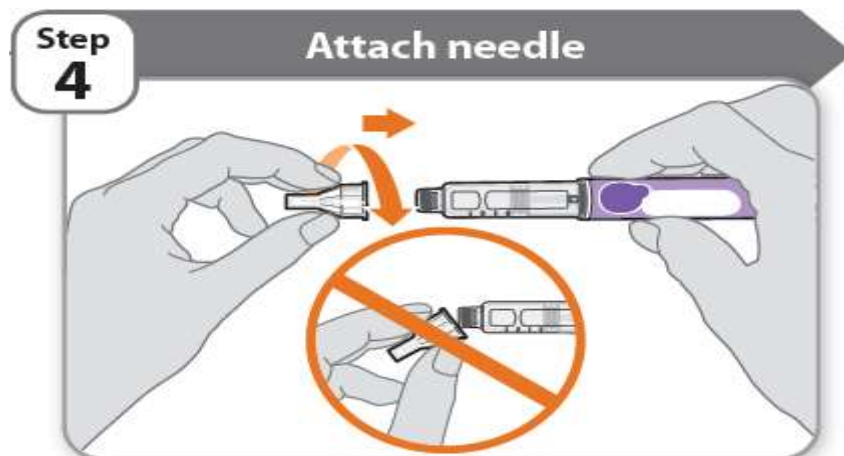

- Take a new needle and pull off the protective paper.
- Line the needle up with your child's pen keeping them both straight.
- Gently push and then screw the needle onto your child's pen.
Do NOT over tighten.
- **Note:** Be careful not to attach the needle at an angle. This may cause the pen to leak.

Caution: Needles have sharp tips at both ends. Handle with care to make sure you do not prick yourself (or anyone else) with the needle.

Step 5 - Pull off outer needle cover

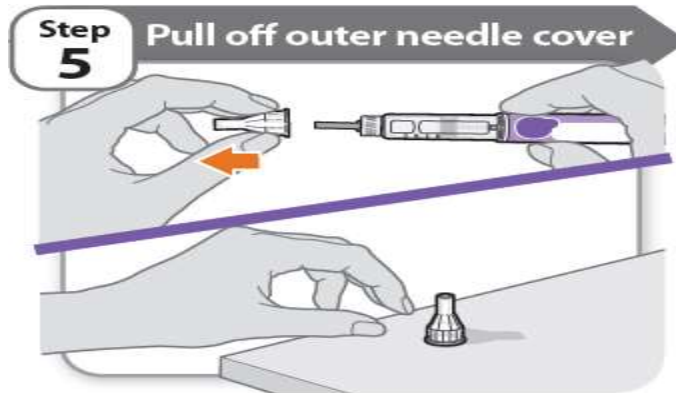

- Pull off the outer needle cover.
- Make sure you keep the outer needle cover. You will need it later to remove the needle.
Note: You should see an inner needle cap after you have removed the outer cover. If you do not see this, try to attach the needle again.

Step 6 - Pull off inner needle cap

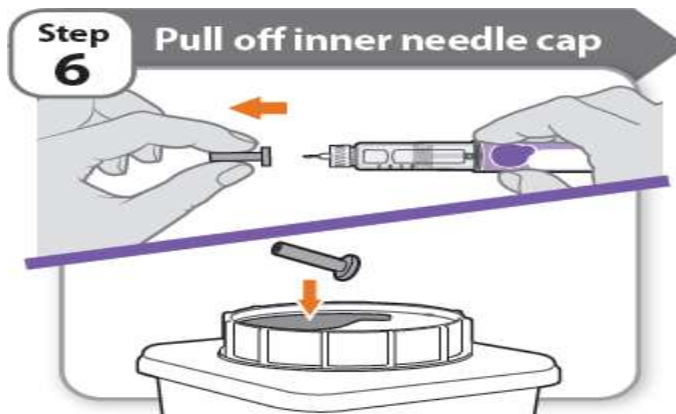

- Pull off the inner needle cap carefully to show the needle.
- Throw away the inner needle cap in an appropriate “sharps” container. It is not needed again.

Is this pen new?

Yes: Go to new pen set up

No



New pen set up (priming) – for the first use of a new pen only

You must set up each new pen (priming) before using it for the first time

- New pen set up is done before each new pen is used for the first time.
- The purpose of setting up a new pen is to remove air bubbles and make sure your child gets the correct dose.

Important: Skip Step-A through to Step-C if you have already set up your child's pen.

A - Set knob to 0.4

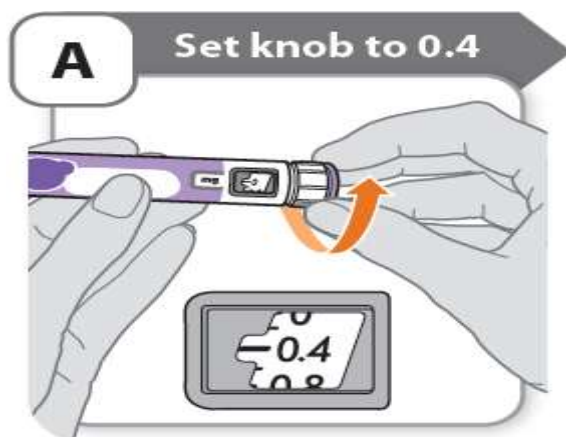

- Turn the dose knob to **0.4**.
Note: If you turn the dose knob too far, you can turn it back.

B - Tap cartridge holder

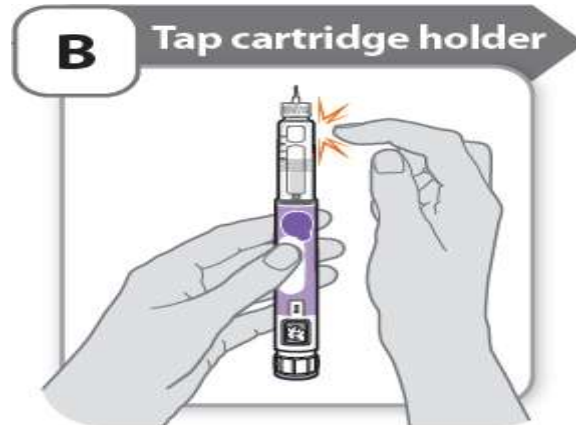

- Hold the pen with the needle pointing up so that the air bubbles can rise.
- **Tap** the cartridge holder gently to float any air bubbles to the top.
Important: Follow Step-B even if you do not see air bubbles.

C - Press button and check for liquid

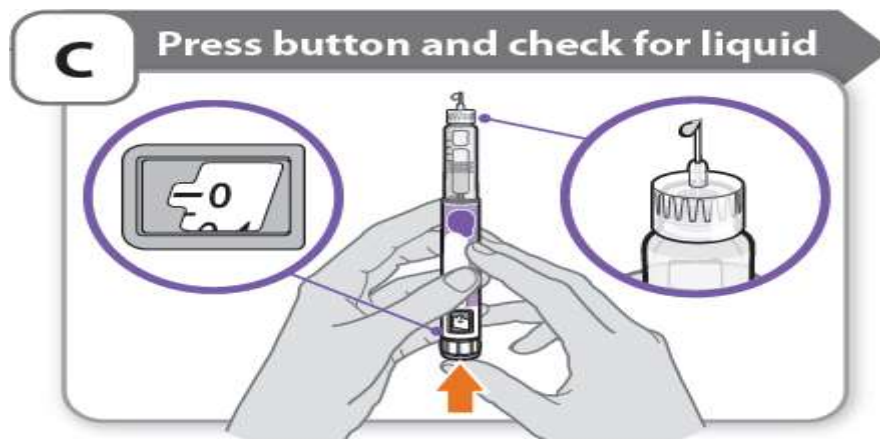

- **Press the injection button** until it cannot go any further and **“0”** is shown in the dose window.
- **Check** for liquid at the needle tip. If liquid appears, your child’s pen is set up.
- Always make sure that a drop of liquid appears before you inject. If liquid has not appeared, repeat Step-A through to Step-C.
 - If liquid does not appear after you have repeated Step-A through Step-C five (5) times, attach a new needle and try 1 more time. **Do not** use the pen if a drop of liquid still does not appear. Contact your child’s healthcare provider or pharmacist, and use a new pen.

Setting your child's prescribed dose

Step 7 - Set your child's dose



Example A:

3.8 mg shown in the dose window

Example A:



3.8 mg shown in the dose window

Example B:

12.0 mg shown in the dose window

Example B:



12.0 mg shown in the dose window

- Turn the dose knob to set your child's dose.
 - The dose can be increased or decreased by turning the dose knob in either direction.
 - The dose knob turns 0.2 mg at a time.
 - Your child's pen contains 24 mg of medicine but you can only set a dose of up to 12 mg for a single injection.
 - The dose window shows the dose in mg. See **Examples A and B**.

- **Always check the dose window to make sure you have set the correct dose.**
Important: Do not press the injection button while setting your child's dose.

What should I do if I cannot set the dose my child needs?

- If your child's dose is more than 12 mg you will need more than 1 injection.
- You can give from 0.2 mg to 12 mg in a single injection.
 - If you need help dividing up your child's dose the right way, ask your child's Healthcare provider.
 - Use a new needle for each injection (See **Step 4: Attach needle**).
 - If you normally need to give 2 injections for your child's full dose, be sure to give your child's second dose.

What should I do if I do not have enough medicine left in my child's pen?

- If your child's pen contains less than 12 mg of medicine, the dose knob will stop with the remaining amount of medicine shown in the dose window.
- If there is not enough medicine left in your child's pen for their full dose, you may either:
 - inject the amount left in your child's pen, then prepare a new pen to complete your child's dose in full. Remember to subtract the dose your child has already received. For example, if the dose is 3.8 mg and you can only set the dose knob to 1.8 mg, you should inject another 2.0 mg with a new pen.
 - Or get a new pen and inject the full dose.

Injecting your child's dose

Step 8 - Insert the needle

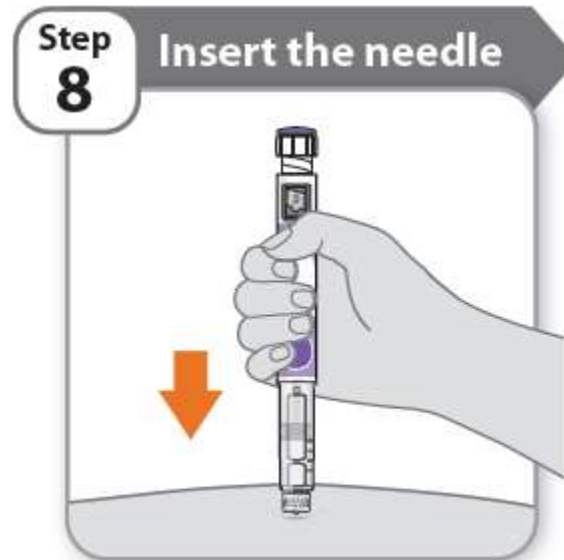

- Hold your child's pen so you can see the numbers in the dose window.

- Insert the needle straight into your child’s skin.

Step 9 - Inject your child’s medicine



- Keep holding the needle in the same position in your child’s skin.
- **Press the injection button** until it cannot go any further and **“0”** is shown in the dose window.

Step 10 - Count to 10

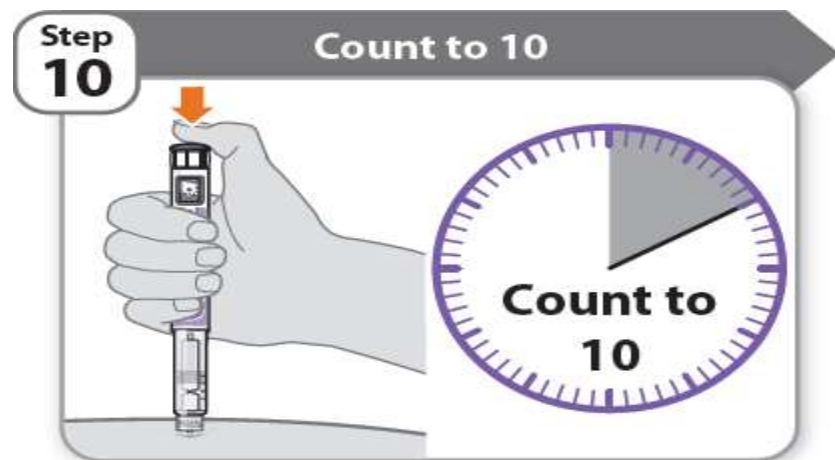

- **Continue to press the injection button while counting to 10.** Counting to 10 will allow the full dose of medicine to be given.
- After counting to 10, let go of the injection button and slowly remove the pen from the injection site by pulling the needle **straight out**.
Note: You may see a drop of medicine at the needle tip. This is normal and does not affect the dose your child just received.

Step 11 - Attach outer needle cover

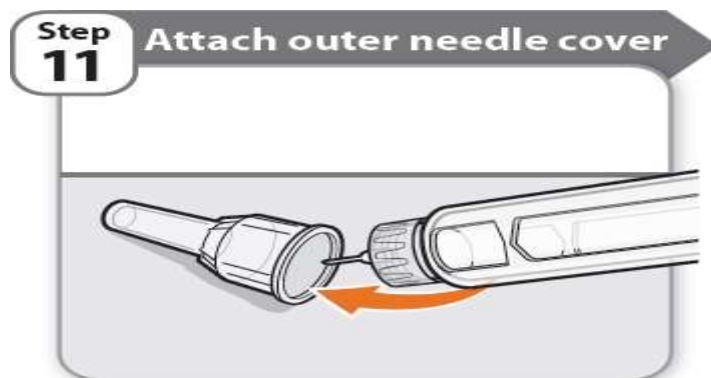

- Carefully place the outer needle cover back on the needle.
 - Press on the outer needle cover until it is secure.
- Caution:** Never try to put the inner needle cap back on the needle. You may prick yourself with the needle.

Step 12 - Remove the needle

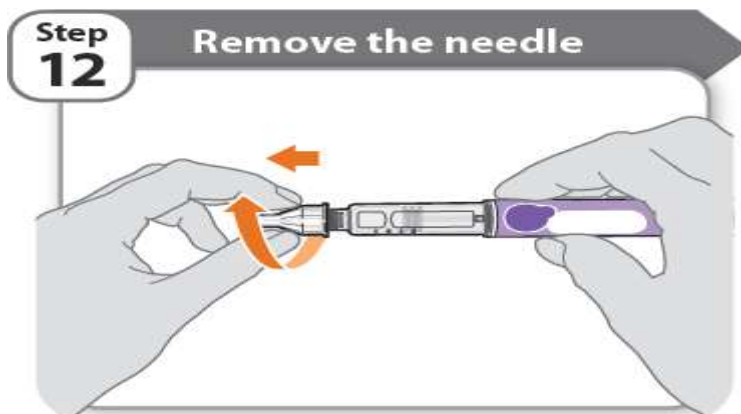

- Unscrew the capped needle from the pen.
 - Gently pull until the capped needle comes off.
- Note:** If the needle is still on, replace the outer needle cover and try again. Be sure to apply pressure when unscrewing the needle.
- Throw away the needle in an appropriate “sharps” container (See How do I dispose of the pen needles and pens?). **Important:** Always remove and throw away used needles. **Do not** reuse needles.

Step 13 - Replace the pen cap

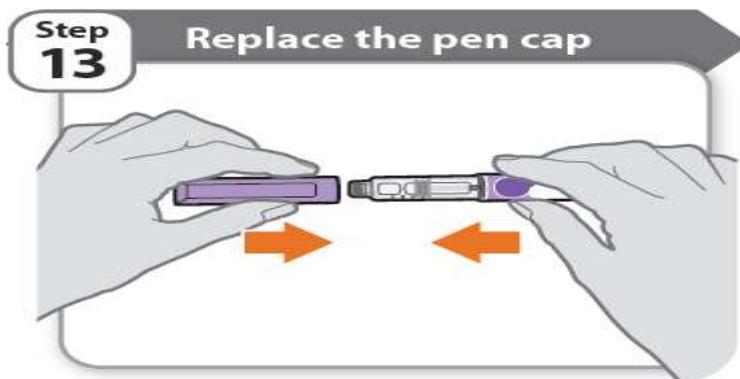

- Replace the pen cap back onto your child's pen.
- **Do not** recap the pen with a needle attached.
- If there is any medicine left in your child's pen, store in the refrigerator between uses (See **How should I store my child's pen?**).

Step 14 - After your child's injection

- Press lightly on the injection site with a clean cotton ball or gauze pad, and hold for a few seconds.
- **Do not** rub the injection site. Your child may have slight bleeding. This is normal.
- You may cover the injection site with a small adhesive bandage, if needed.
- If your child's pen is empty, has been used 5 times, has been left out of the refrigerator (up to 32°C) for more than 2 hours with each use, has been exposed to temperatures above 32°C or it has been **more than 28 days** after first use, throw it away even if it contains unused medicine. Refer to "**Storage and disposal**" on the right side of this leaflet.

Storage and disposal:

How should I store my child's pen?

- Keep Ngenla, injection supplies, and all medicines out of the reach of children.

Before first use (unused pens):

- Store your child's pens in the refrigerator between 2°C to 8°C.
- Do NOT freeze your child's pen or expose it to heat.
- Unused pens may be used until the expiration date printed on the label, only if the pen has been kept in the refrigerator.

After first use (up to 28 days of use):

- Store your child's pen in the refrigerator between 2°C to 8°C in between each use and away from direct sunlight.

- Keep the pen cap on your child’s pen when it is not in use.
- **Do not** store the pen with a needle attached.
- If your child’s pen is empty, has been used 5 times, has been left out of the refrigerator (up to 32°C) for more than 2 hours with each use, has been exposed to temperatures above 32°C or it has been **more than 28 days** after first use, throw it away even if it contains unused medicine.
- To help you remember when to dispose of your child’s pen, you can write the date of first use on the pen label and below:

Date of first use _____ / _____ / _____

- When travelling, transport your child’s pen in its original carton in an insulated container with an ice pack. To avoid freezing, make sure your child’s pen does not touch the ice pack. Once you arrive, your child’s pen should be placed in a refrigerator as soon as possible. **Do not** leave it in a car or other place where it can get too hot or too cold.

How should I dispose of the pen needles and pens?

- Throw away your child’s pen, and pen needles into an appropriate “sharps” disposal container or puncture resistant container.
- If you do not have a “sharps” disposal container, you may use a household container that:
 - is made of heavy-duty plastic.
 - can be closed with a tight-fitting, puncture resistant lid, without sharps being able to come out.
 - is upright and stable during use.
 - is leak-resistant, and properly labeled to warn of hazardous waste inside the container.
- When your “sharps” disposal container is almost full, you will need to follow your community guidelines for the right way to dispose of your “sharps” disposal container. There may be local laws about how you should throw away used needles, syringes, and pre-filled syringes. Ask your child’s doctor or nurse, if you are not sure what to do.
- **Do not** throw away your used sharps disposal container in your household trash unless your community guidelines permit this.
- Keep the sharps container out of the reach of children.

NGENLA®

Somatrogon Injection

60 mg/1.2 mL (50 mg/mL), pre-filled pen for subcutaneous injection

INSTRUCTIONS FOR USE (IFU)

Injection for subcutaneous (under the skin) use only

Keep this leaflet. These instructions show step-by-step directions on how to prepare and give an injection.

Important information about your child's Ngenla pen

- Ngenla for injection is a single-patient use, disposable (throw away) pre-filled pen containing 60 mg of medicine. You can give more than 1 dose from the pen.
- Ngenla for injection can be given by a patient, caregiver or healthcare provider. **Do NOT** try to inject Ngenla yourself until you are shown the right way to give the injections and read and understand the Instructions for Use. If your child's healthcare provider decides that you may be able to give your child's injections of Ngenla at home, you should receive training on the right way to prepare and inject Ngenla. It is important that you read, understand, and follow these instructions so that you inject Ngenla the right way.
- It is important to talk to your child's healthcare provider to be sure you understand your child's Ngenla dosing instructions. To help you remember when to inject Ngenla, you can mark your calendar ahead of time. Call your child's healthcare provider if you have any questions about the right way to inject Ngenla, or by calling Pfizer Canada ULC at 1-800-463-6001.
- **Do NOT** share your child's pen with other people, even if the needle has been changed. Your child may give other people a serious infection, or get a serious infection from them.
- Each turn (click) of the dose knob dials 0.5 mg of medicine. You can give from 0.5 mg to 30 mg in a single injection. If your child's dose is more than 30 mg, you may need to give more than 1 injection.
- A new pen may contain slightly more than 60 mg of medicine, this is normal.
- Always use a new sterile needle for each injection. This will reduce the risk of contamination, infection, leakage of medicine, and blocked needles leading to the wrong dose.
- **Do NOT** shake your child's pen. Shaking can damage the medicine.
- The pen is **not recommended** for use by the blind or visually impaired without the assistance of a person trained in the proper use of the product.

Supplies you will need each time you inject

Included in the carton:

- 1 Ngenla pre-filled pen.

Not included in the carton:

- 1 new sterile needle for each injection.
- Alcohol swabs.
- Cotton balls or gauze pads.
- Adhesive bandage.
- 1 appropriate “sharps” disposal container for disposal of pen needles and pens (See How should I dispose of the pen needles and pens?).

60 mg NGENLA pen:

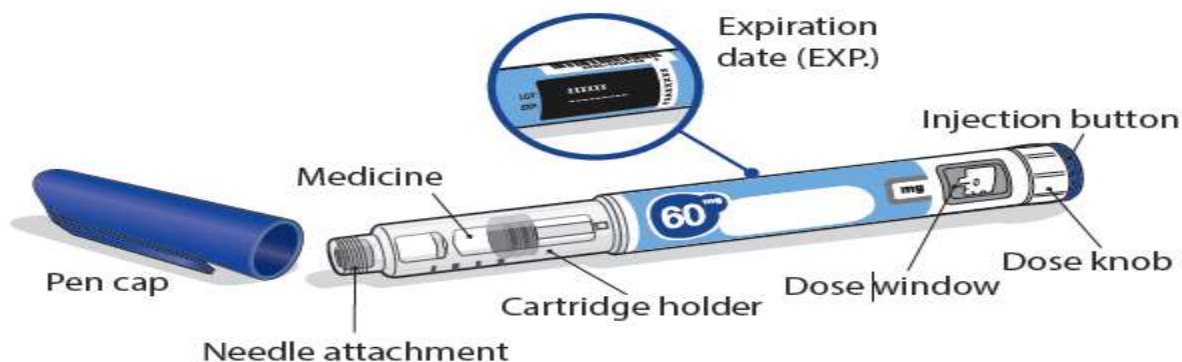

Needles to use

Pen needles are **not included** with your child’s Ngenla pen. You will need a prescription from your child’s healthcare provider to get pen needles up to a length of 8 mm from your pharmacy.

- Needles to use with your child’s Ngenla pen:
 - 32G or 31G (Novo Nordisk®)
 - 31G (Becton Dickinson and Company)
- Talk with your child’s healthcare provider about the right needle for your child.

Sterile needle (example) not supplied:

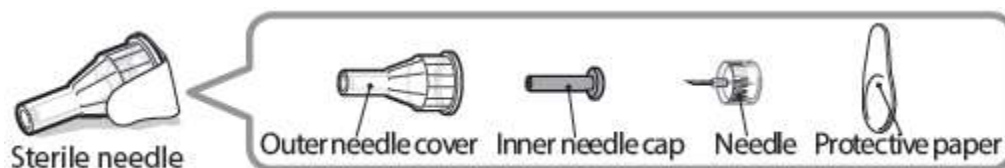

Caution: Never use a bent or damaged needle. Always handle pen needles with care to make sure you do not prick yourself (or anyone else) with the needle. **Do NOT** attach a new needle to your pen until you are ready to take your injection.

Prior to each use the pen can be left at room temperature for a more comfortable injection, not more than 32 °C for a maximum 2 hours. Do not use beyond the expiration date stamped on the carton.

Preparing for your injection

Step 1 - Getting ready

- Wash and dry your hands.
- You can use your child's pen straight from the refrigerator. For a more comfortable injection, leave your child's pen at room temperature for up to 30 minutes.
- Check the name, strength, and label of your child's pen to make sure it is the medicine your child's healthcare provider has prescribed for your child.
- Check the expiration date on the pen label. **Do NOT** use if the expiration date has passed.
- **Do NOT** use your child's pen if:
 - it has been frozen or exposed to heat.
 - it has been dropped.
 - it looks broken or damaged.
 - it has been more than 28 days after first use of the pen.
 - It has been used 5 times.
 - It has been left out of the refrigerator (up to 32°C) for more than 2 hours with each use.
 - It has been exposed to temperatures above 32°C
- **Do not** remove the pen cap from your child's pen - until you are ready to inject.

Step 2 - Choose and clean your child's injection site



- Ngenla can be given in the abdomen, thighs, buttocks, or upper arms.
- Choose the best place to inject, as recommended by your child's healthcare provider.
- If more than 1 injection is needed to complete your child's full dose, each injection should be given in a different injection site.
- **Do not** inject into bony areas, areas that are bruised, red, sore or hard, and areas that have scars or skin conditions.
- Clean the injection site with an alcohol swab.
- Allow the injection site to dry.
- **Do NOT** touch injection site after cleaning.

Step 3 - Check medicine



- Pull off the pen cap and keep it for after your child's injection.
- Check the medicine inside the cartridge holder.
- Make sure the medicine is clear and colorless to slightly light yellow. **Do NOT** inject the medicine if it is cloudy or dark yellow.
- Make sure the medicine is free of flakes or particles. **Do NOT** inject the medicine if it has flakes or particles.

Note: It is normal to see one or more bubbles in the medicine.

Step 4 - Attach needle

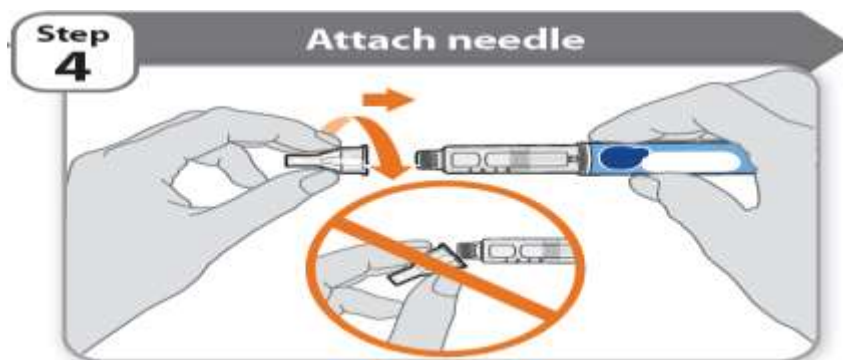

- Take a new needle and pull off the protective paper.
- Line the needle up with your child's pen keeping them both straight.
- Gently push and then screw the needle onto your child's pen.

Do not over tighten.

Note: Be careful not to attach the needle at an angle. This may cause the pen to leak.

Caution: Needles have sharp tips at both ends. Handle with care to make sure you do not prick yourself (or anyone else) with the needle.

Step 5 - Pull off outer needle cover

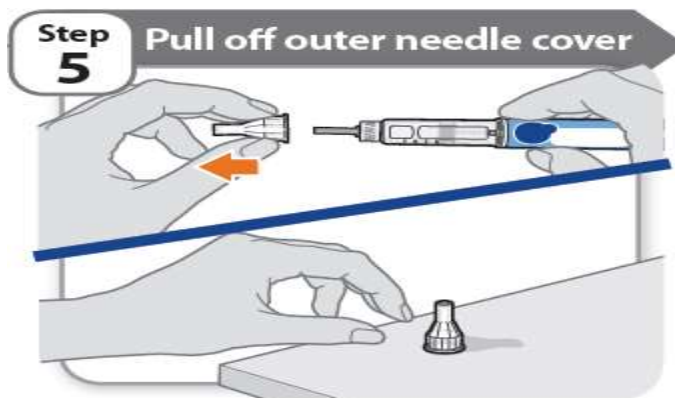

- Pull off the outer needle cover.
- Make sure you keep the outer needle cover. You will need it later to remove the needle.

Note: You should see an inner needle cap after you have removed the outer cover. If you do not see this, try to attach the needle again.

Step 6 - Pull off inner needle cap

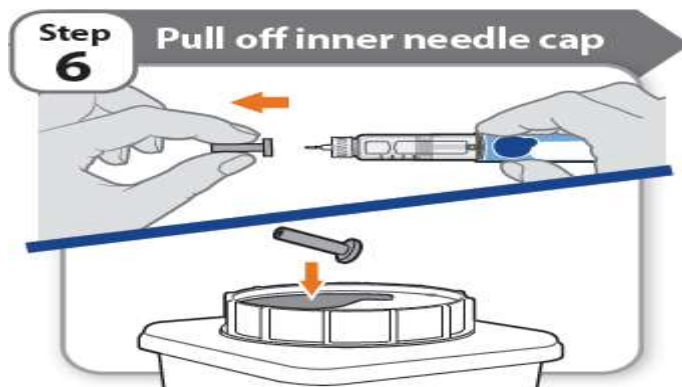

- Pull off the inner needle cap carefully to show the needle.
- Throw away the inner needle cap in an appropriate “sharps” container. It is not needed again.

Is this pen new?

Yes: Go to new pen set up

No



New pen set up (priming) – for the first use of a new pen only

You must set up each new pen (priming) before using it for the first time

- New pen set up is done before each new pen is used for the first time.
- The purpose of setting up a new pen is to remove air bubbles and make sure your child gets the correct dose.

Important: Skip Step-A through to Step-C if you have already set up your child's pen.

A - Set knob to 1.0

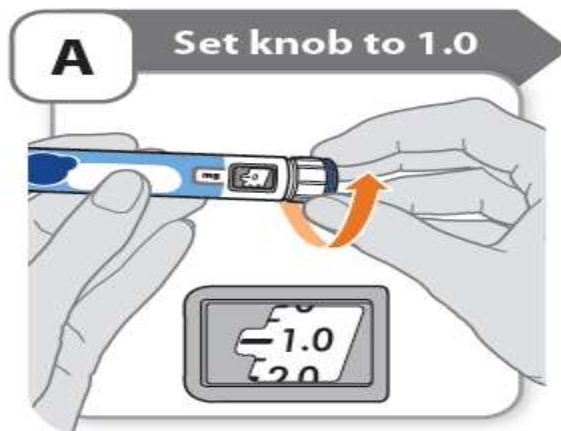

- Turn the dose knob to **1.0**.
Note: If you turn the dose knob too far, you can turn it back.

B - Tap cartridge holder



- Hold the pen with the needle pointing up so that the air bubbles can rise.
- **Tap** the cartridge holder gently to float any air bubbles to the top.
Important: Follow Step-B even if you do not see air bubbles.

C - Press button and check for liquid

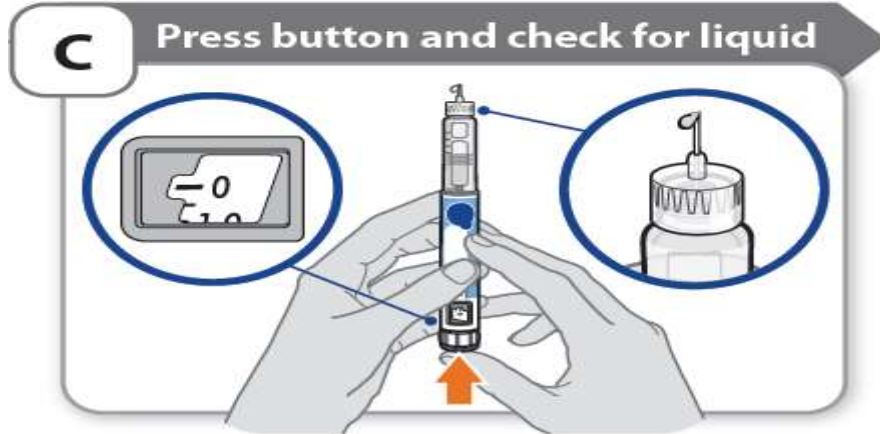

- **Press the injection button** until it cannot go any further and “0” is shown in the dose window.
- **Check** for liquid at the needle tip. If liquid appears, your child’s pen is set up.
- Always make sure that a drop of liquid appears before you inject. If liquid has not appeared, repeat Step-A through to Step-C.
 - If liquid does not appear after you have repeated Step-A through Step-C five (5) times, attach a new needle and try 1 more time. **Do NOT** use the pen if a drop of liquid still does not appear. Contact your child’s healthcare provider or pharmacist, and use a new pen.

Setting your child’s prescribed dose

Step 7 - Set your child’s dose

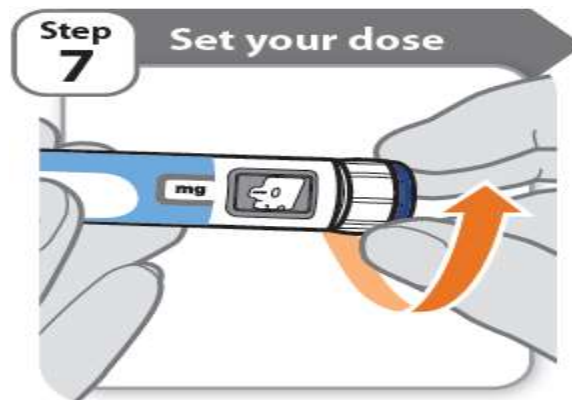

Example A:

21.5 mg shown in the dose window

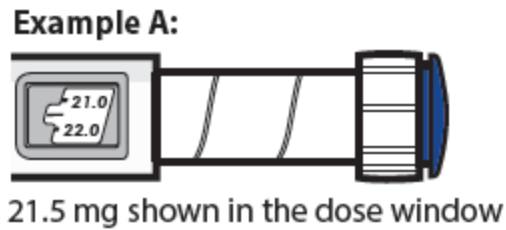

Example B:

30.0 mg shown in the dose window

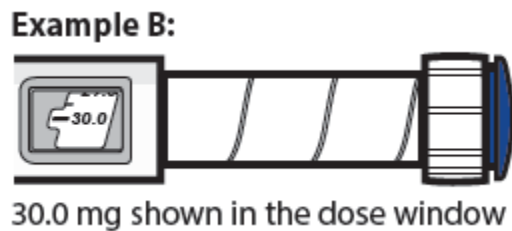

- Turn the dose knob to set your child's dose.
 - The dose can be increased or decreased by turning the dose knob in either direction.
 - The dose knob turns 0.5 mg at a time.
 - Your child's pen contains 60 mg of medicine but you can only set a dose of up to 30 mg for a single injection.
 - The dose window shows the dose in mg. See **Examples A and B**.
- **Always check the dose window to make sure you have set the correct dose.**
Important: Do not press the injection button while setting your child's dose.

What should I do if I cannot set the dose my child needs?

- If your child's dose is more than 30 mg you will need more than 1 injection.
- You can give from 0.5 mg to 30 mg in a single injection.
 - If you need help dividing up your child's dose the right way, ask your child's Healthcare provider.
 - Use a new needle for each injection (See **Step 4: Attach needle**).
 - If you normally need to give 2 injections for your child's full dose, be sure to give your child's second dose.

What should I do if I do not have enough medicine left in my child's pen?

- If your child's pen contains less than 30 mg of medicine, the dose knob will stop with the remaining amount of medicine shown in the dose window.

- If there is not enough medicine left in your child’s pen for your child’s full dose, you may either:
 - inject the amount left in your child’s pen, then prepare a new pen to complete your child’s dose in full. Remember to subtract the dose your child has already received. For example, if the dose is 21.5 mg and you can only set the dose knob to 17 mg, you should inject another 4.5 mg with a new pen.
 - Or get a new pen and inject the full dose.

Injecting your child’s dose

Step 8 - Insert the needle

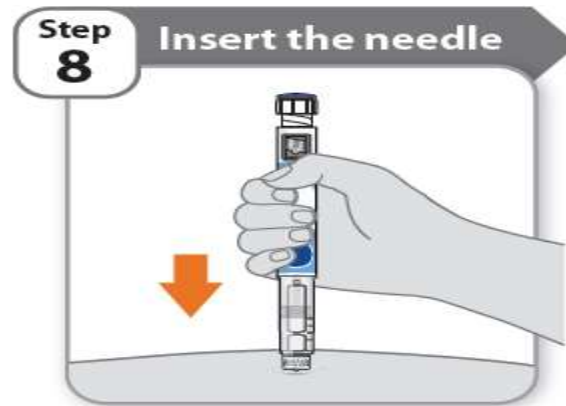

- Hold your child’s pen so you can see the numbers in the dose window.
- Insert the needle straight into your child’s skin.

Step 9 - Inject your child’s medicine



- Keep holding the needle in the same position in your child’s skin.
- **Press the injection button** until it cannot go any further and “0” is shown in the dose window.

Step 10 - Count to 10

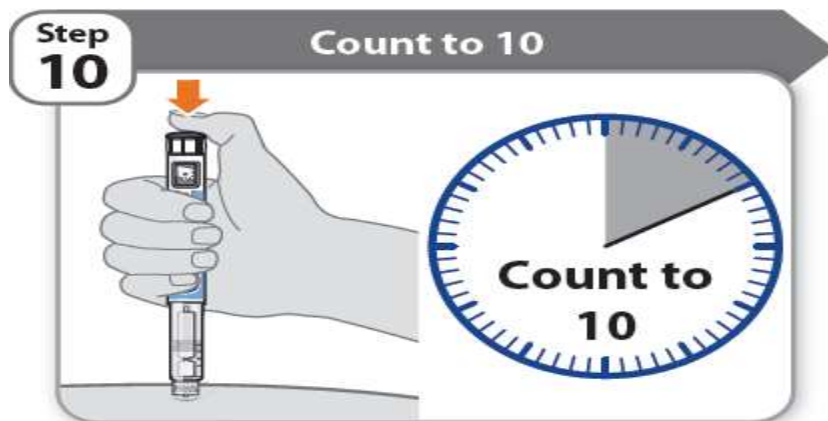

- **Continue to press the injection button while counting to 10.** Counting to 10 will allow the full dose of medicine to be given.
- After counting to 10, let go of the injection button and slowly remove the pen from the injection site by pulling the needle **straight out**.

Note: You may see a drop of medicine at the needle tip. This is normal and does not affect the dose your child just received.

Step 11 - Attach outer needle cover

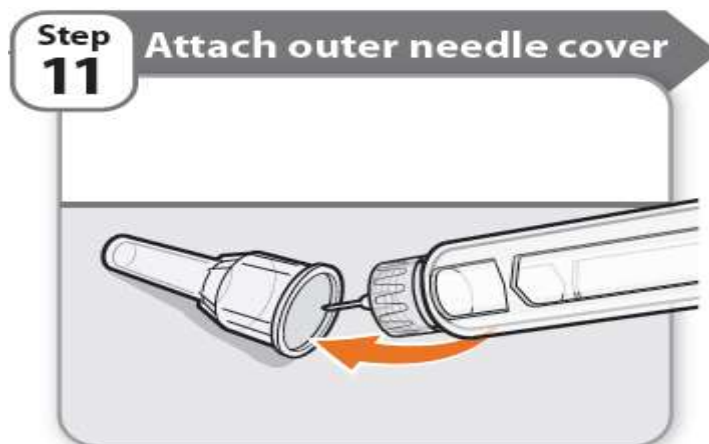

- Carefully place the outer needle cover back on the needle.
 - Press on the outer needle cover until it is secure.
- Caution:** Never try to put the inner needle cap back on the needle. You may prick yourself with the needle.

Step 12 - Remove the needle

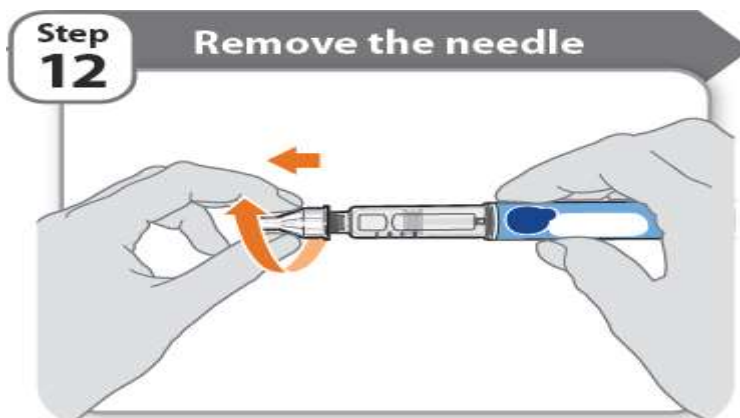

- Unscrew the capped needle from the pen.
- Gently pull until the capped needle comes off.
Note: If the needle is still on, replace the outer needle cover and try again. Be sure to apply pressure when unscrewing the needle.
- Throw away the needle in the sharps container (See How do I dispose of the pen needles and pens?). **Important:** Always remove and throw away used needles. **Do NOT** reuse needles.

Step 13 - Replace the pen cap

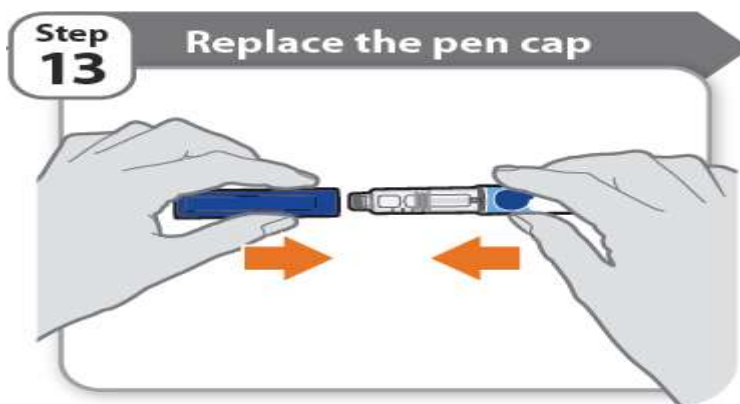

- Replace the pen cap back onto your child's pen.
- **Do NOT** recap the pen with a needle attached.
- If there is any medicine left in your child's pen, store in the refrigerator between uses (See **How should I store my child's pen?**).

Step 14 - After your child's injection

- Press lightly on the injection site with a clean cotton ball or gauze pad, and hold for a few seconds.
- **Do NOT** rub the injection site. Your child may have slight bleeding. This is normal.
- You may cover the injection site with a small adhesive bandage, if needed.
- If your child's pen is empty, has been used 5 times, has been left out of the refrigerator (up to 32°C) for more than 2 hours with each use, has been exposed to temperatures above 32°C or it has been **more than 28 days** after first use, throw it away even if it contains unused medicine. Refer to "**Storage and disposal**" on the right side of this leaflet.

Storage and disposal:

How should I store my child's pen?

- Keep Ngenla, injection supplies, and all medicines out of the reach of children.

Before first use (unused pens):

- Store your child's pens in the refrigerator between 2°C to 8°C.
- Do NOT freeze your child's pen or expose it to heat.
- Unused pens may be used until the expiration date printed on the label, only if the pen has been kept in the refrigerator.

After first use (up to 28 days of use):

- Store your child's pen in the refrigerator at 2°C to 8°C in between each use and away from direct sunlight.
- Keep the pen cap on your child's pen when it is not in use.
- **Do NOT** store the pen with a needle attached.
- If your child's pen is empty, has been used 5 times, has been left out of the refrigerator (up to 32°C) for more than 2 hours with each use, has been exposed to temperatures above 32°C or it has been **more than 28 days** after first use, throw it away even if it contains unused medicine.
- To help you remember when to dispose of your child's pen you can write the date of first use on the pen label and below:

Date of first use _____ / _____ / _____

- When travelling, transport your child's pen in its original carton in an insulated container with an ice pack. To avoid freezing, make sure your child's pen does not touch the ice pack. Once you arrive, your child's pen should be placed in a refrigerator as soon as possible. **Do NOT** leave it in a car or other place where it can get too hot or too cold.

How should I dispose of the pen needles and pens?

- Throw away your child’s pen, and pen needles into an appropriate “sharps” disposal container or puncture resistant container.
- If you do not have a “sharps” disposal container, you may use a household container that:
 - is made of heavy-duty plastic
 - can be closed with a tight-fitting, puncture resistant lid, without sharps being able to come out
 - is upright and stable during use
 - is leak-resistant, and properly labeled to warn of hazardous waste inside the container.
- When your “sharps” disposal container is almost full, you will need to follow your community guidelines for the right way to dispose of your “sharps” disposal container. There may be local laws about how you should throw away used needles, syringes, and pre-filled syringes. Ask your child’s doctor or nurse, if you are not sure what to do.
- **Do NOT** throw away your used sharps disposal container in your household trash unless your community guidelines permit this.
- Keep the sharps container out of the reach of children.