

PRODUCT MONOGRAPH
INCLUDING PATIENT MEDICATION INFORMATION

PrOVIDREL®

choriogonadotropin alfa

250 mcg solution for injection in pre-filled syringe or pre-filled pen

Pharmaceutical Standard: Manufacturer's

Gonadotrophin

EMD Serono, A Division of EMD Inc., Canada
2695 North Sheridan Way, Suite 200
Mississauga, Ontario Canada L5K 2N6
www.emdserono.ca
EMD Serono is a business of Merck KGaA, Darmstadt, Germany

Date of Initial Authorization:
Dec 16, 2004

Date of Revision:
Oct 12, 2023

Submission Control Number: 274651

OVIDREL® is a trademark of Merck KGaA, Darmstadt, Germany or its affiliates.

RECENT MAJOR LABEL CHANGES

7 WARNING AND PRECAUTIONS, Reproductive Health: Female
--

04/2023

TABLE OF CONTENTS

Sections or subsections that are not applicable at the time of authorization are not listed.

RECENT MAJOR LABEL CHANGES	2
TABLE OF CONTENTS	2
PART I: HEALTH PROFESSIONAL INFORMATION	4
1 INDICATIONS	4
1.1 Pediatrics.....	4
1.2 Geriatrics.....	4
2 CONTRAINDICATIONS	4
4 DOSAGE AND ADMINISTRATION	4
4.1 Dosing Considerations	4
4.2 Recommended Dose and Dosage Adjustment	5
4.3 Reconstitution.....	5
5 OVERDOSAGE	5
6 DOSAGE FORMS, STRENGTHS, COMPOSITION AND PACKAGING	5
7 WARNINGS AND PRECAUTIONS	6
7.1 Special Populations	9
7.1.1 Pregnant Women.....	9
7.1.2 Breast-feeding.....	9
7.1.3 Pediatrics.....	9
7.1.4 Geriatrics.....	9
8 ADVERSE REACTIONS	9
8.1 Adverse Reaction Overview	9
8.2 Clinical Trial Adverse Reactions	10
8.3 Less Common Clinical Trial Adverse Reactions.....	11
8.5 Post-Market Adverse Reactions.....	11
9 DRUG INTERACTIONS	12
10 CLINICAL PHARMACOLOGY	12

10.1	Mechanism of Action	12
10.2	Pharmacodynamics.....	13
10.3	Pharmacokinetics.....	13
11	STORAGE, STABILITY AND DISPOSAL.....	14
12	SPECIAL HANDLING INSTRUCTIONS.....	14
PART II: SCIENTIFIC INFORMATION		15
13	PHARMACEUTICAL INFORMATION	15
14	CLINICAL TRIALS	16
14.1	Trial Design and Study Demographics	16
14.2	Study Results.....	16
16	NON-CLINICAL TOXICOLOGY	17
PATIENT MEDICATION INFORMATION		19

PART I: HEALTH PROFESSIONAL INFORMATION

1 INDICATIONS

Ovidrel is indicated for the induction of ovulation (OI) and pregnancy in patients undergoing fertility treatment in whom the cause of infertility is functional and not due to primary ovarian failure.

1.1 Pediatrics

Ovidrel is only intended for use in female patients of reproductive age, therefore, safety and effectiveness in pediatric patients has not been established.

1.2 Geriatrics

Ovidrel is only intended for use in female patients of reproductive age, therefore, safety and effectiveness in geriatric patients has not been established.

2 CONTRAINDICATIONS

Ovidrel is contraindicated in women who exhibit:

- Hypersensitivity to choriogonadotropin alfa or to any of the excipients
- Primary ovarian failure
- Uncontrolled thyroid or adrenal dysfunction
- Tumours of the hypothalamus and pituitary gland
- Abnormal uterine bleeding of undetermined origin (see [4.1 DOSAGE AND ADMINISTRATION, Dosing Considerations, Selection of Patients](#))
- Ovarian enlargement or cyst of unknown aetiology (see [4.1 DOSAGE AND ADMINISTRATION, Dosing Considerations, Selection of Patients](#))
- Ovarian, uterine or mammary cancer
- Pregnancy

4 DOSAGE AND ADMINISTRATION

4.1 Dosing Considerations

Selection of Patients

- Before treatment with gonadotrophins is instituted, a thorough gynecologic and endocrinologic evaluation must be performed. This should include an assessment of pelvic anatomy. Patients with tubal obstruction should receive Ovidrel only if enrolled in an in vitro fertilization program.
- Primary ovarian failure should be excluded by the determination of gonadotrophin levels.
- Appropriate evaluation should be performed to exclude pregnancy.
- Women in later reproductive life have a greater predisposition to endometrial carcinoma as well as a higher incidence of anovulatory disorders. A thorough diagnostic evaluation should always be performed in patients who demonstrate abnormal uterine bleeding or other signs of endometrial

abnormalities before starting follicle stimulating agent and Ovidrel therapy.

- Evaluation of the partner's fertility potential should be included in the initial evaluation.

4.2 Recommended Dose and Dosage Adjustment

Ovidrel should not be administered until adequate follicular development is indicated by serum estradiol and/or vaginal ultrasonography.

Ovidrel 250 mcg should be administered subcutaneously one day following the last dose of the follicle stimulating agent. Ovidrel administration should be withheld in situations where there is an excessive ovarian response, as evidenced by multiple follicular development, clinically significant ovarian enlargement or excessive estradiol production.

4.3 Reconstitution

Reconstituted Solutions:

Solution for Injection: The solution in the pre-filled syringe or pre-filled pen is ready for use. Single use only.

Parenteral Products:

The pre-filled syringe solution or pre-filled pen solution should not be administered if it contains particles or is not clear. Administration by the subcutaneous route.

In the absence of compatibility studies, this medicinal product should not be mixed with other medicinal products.

5 OVERDOSAGE

No case of overdosage has been reported. Nevertheless, there is a possibility that OHSS may result from an overdosage of Ovidrel (see 7 WARNINGS AND PRECAUTIONS).

For management of a suspected drug overdose, contact your regional poison control centre.

6 DOSAGE FORMS, STRENGTHS, COMPOSITION AND PACKAGING

Table 1 – Dosage Forms, Strengths, Composition and Packaging

Route of Administration	Dosage Form / Strength/Composition	Non-medicinal Ingredients
Subcutaneously (pre-filled syringe)	Solution / 250 mcg choriogonadotropin alfa	L-methionine, mannitol, phosphoric acid, poloxamer 188, sodium hydroxide, water for injection
Subcutaneously (pre-filled pen)	Solution / 250 mcg choriogonadotropin alfa	Disodium hydrogen phosphate dihydrate, L-methionine, mannitol, phosphoric acid, poloxamer 188, sodium dihydrogen phosphate monohydrate, sodium hydroxide, water for injection

Ovidrel is a sterile, clear and colourless solution.

Ovidrel is supplied in two formats:

- Sterile solution in a ready-to-use pre-filled syringe containing 250 mcg of r-hCG
- Sterile solution in a ready-to-use pre-filled pen containing 250 mcg of r-hCG

The following package combinations are available:

- 1 pre-filled syringe of Ovidrel 250 mcg solution for Injection
- 1 pre-filled pen of Ovidrel 250 mcg solution for Injection and 2 needles to be used with the pen for administration

7 WARNINGS AND PRECAUTIONS

General

Gonadotrophins, including Ovidrel, should only be used by healthcare professionals who are thoroughly familiar with infertility problems and their management. Like other hCG products, Ovidrel is a potent gonadotrophic substance capable of causing Ovarian Hyperstimulation Syndrome (OHSS) in women with or without pulmonary or vascular complications. Gonadotrophin therapy requires a certain time commitment by healthcare professionals and supportive healthcare professionals, and requires the availability of appropriate monitoring facilities (see [7 WARNINGS AND PRECAUTIONS, Monitoring and Laboratory Tests](#)). Safe and effective induction of ovulation and use of Ovidrel in women requires monitoring of ovarian response with serum estradiol and transvaginal ultrasound on a regular basis.

Careful attention should be given to the diagnosis of infertility in candidates for hCG therapy (see [4.1 DOSAGE AND ADMINISTRATION, Dosing Considerations, Selection of Patients](#)). After the exclusion of pre-existing conditions, elevations in ALT were found in 10 (3%) of 335 patients receiving Ovidrel 250 mcg, 9 (10%) of 89 patients receiving Ovidrel 500 mcg and in 16 (4.8%) of 328 patients receiving urinary-derived hCG. The elevations ranged up to 1.2 times the upper limit of normal. The clinical significance of these findings is not known.

Information for Patients: Prior to therapy with hCG, patients should be informed:

- Of the duration of treatment and monitoring of their condition that will be required
- Of their personal risk of OHSS
- That there is a potential risk of multiple births
- That there is a potential for a false positive pregnancy test for the 10 days following administration of hCG

Carcinogenesis and Mutagenesis

Long-term studies to evaluate the carcinogenic potential of Ovidrel in animals have not been performed. In vitro genotoxicity testing of Ovidrel in bacteria and mammalian cell lines, chromosome aberration assay in human lymphocytes and in vivo mouse micronucleus have shown no indication of genetic defects.

Cardiovascular

As with other hCG products, a potential for the occurrence of arterial thromboembolism exists. In women with recent or ongoing thromboembolic disease or with generally recognized risk factors for thromboembolic events, such as personal or family history, treatment with gonadotrophins may further increase the risk. In these women, the benefits of gonadotrophin administration need to be weighed against the risks. It should be noted however, that pregnancy itself as well as OHSS also carry

an increased risk of thromboembolic events.

Monitoring and Laboratory Tests

In most instances, treatment of women with follicle stimulating agents results only in follicular recruitment and development. In the absence of an endogenous LH surge, hCG is given when monitoring of the patient indicates that sufficient follicular development has occurred. This may be estimated by ultrasound alone or in combination with measurement of serum estradiol levels. The combination of both ultrasound and serum estradiol measurement are useful for monitoring the development of follicles, for timing of the ovulatory trigger, as well as for detecting ovarian enlargement and minimizing the risk of the OHSS and multiple gestation. It is recommended that the number of growing follicles be confirmed using ultrasonography because serum estrogen levels do not give an indication of the size or number of follicles.

Human chorionic gonadotrophins can cross-react in the radioimmunoassay of gonadotrophins, especially luteinizing hormone. Each individual laboratory should establish the degree of cross-reactivity with their gonadotrophin assay. Healthcare professionals should make the laboratory aware of patients on hCG if gonadotrophin levels are requested.

The clinical confirmation of ovulation, with the exception of pregnancy, is obtained by direct and indirect indices of progesterone production. The indices most generally used are as follows:

- A rise in basal body temperature
- Increase in serum progesterone and
- Menstruation following a shift in basal body temperature

When used in conjunction with the indices of progesterone production, sonographic visualization of the ovaries will assist in determining if ovulation has occurred. Sonographic evidence of ovulation may include the following:

- Fluid in the cul-de-sac
- Ovarian stigmata suggestive of a corpus luteum
- Collapsed follicle

Accurate interpretation of the indices of ovulation requires a healthcare professional who is experienced in the interpretation of these tests.

Reproductive Health:

Reproductive Complications

As with other hCG products, reports of multiple births have been associated with Ovidrel treatment when used in combination with follicle stimulating agents. In patients undergoing induction of ovulation, the incidence of multiple pregnancies and births is increased compared with conception in natural, non-stimulated cycles. Multiple pregnancy, especially higher order multiples, carry an increased risk of adverse maternal and perinatal outcomes. To minimise the risk of multiple pregnancy, careful monitoring of ovarian response is recommended. The risk of multiple births correlates to the number of embryos transferred or mature follicles that develop for ovulation induction. In assisted reproductive technologies (ART) clinical trials, involving in vitro fertilization and embryo transfer in women receiving Ovidrel 250 mcg, multiple births occurred in 17 of 55 live deliveries (30.9 %). In the ovulation induction clinical trial, 2 of 15 live deliveries (13.3%) were associated with multiple births in women receiving Ovidrel 250 mcg. The patient should be advised of the potential risk of multiple births before starting treatment with follicle stimulating agents and Ovidrel.

Fertility

Overstimulation of the Ovary Following hCG Therapy

Ovarian Enlargement: Mild to moderate uncomplicated ovarian enlargement which may be accompanied by abdominal distention and/or abdominal pain may occur in patients treated with follicle stimulating agents and hCG, and generally regresses without treatment within two or three weeks. Careful monitoring of ovarian response can further minimize the risk of overstimulation. If the ovaries are abnormally enlarged on the last day of follicle stimulating agent therapy, choriogonadotropin alfa may be withheld in this course of therapy. This will reduce the risk of development of OHSS.

Ovarian Hyperstimulation Syndrome (OHSS): A certain degree of ovarian enlargement is an expected effect of controlled ovarian stimulation. It is more commonly seen in women with polycystic ovarian syndrome and usually regresses without treatment.

OHSS is a medical event distinct from uncomplicated ovarian enlargement. Mild manifestations of OHSS may include abdominal pain, abdominal discomfort and distension, or enlarged ovaries. Moderate OHSS may additionally present with nausea, vomiting, ultrasound evidence of ascites or marked ovarian enlargement.

Severe OHSS further includes symptoms such as severe ovarian enlargement, weight gain, dyspnoea or oliguria. Severe OHSS may progress rapidly (within 24 hours to several days) to become a serious medical event. It is characterized by an increase in vascular permeability, which can result in a rapid accumulation of fluid in the peritoneal cavity, thorax, and potentially, the pericardium.

Clinical evaluation may reveal hypovolemia, hemoconcentration, electrolyte imbalances, ascites, hemoperitoneum, pleural effusions, hydrothorax, or acute pulmonary distress. Very rarely, severe OHSS may be complicated by ovarian torsion or thromboembolic events, such as pulmonary embolism, ischaemic stroke or myocardial infarction. Severe OHSS is potentially life-threatening.

Independent risk factors for developing OHSS include young age (age < 30 years of age), lean body mass, polycystic ovarian syndrome, higher doses of exogenous gonadotropins, high absolute or rapidly rising serum oestradiol levels and previous episodes of OHSS, large number of developing ovarian follicles and large number of oocytes retrieved in ART cycles.

Adherence to recommended Ovidrel dosage and regimen of administration can minimise the risk of ovarian hyperstimulation. Monitoring of stimulation cycles by ultrasound scans as well as oestradiol measurements are recommended to identify risk factors early.

There is evidence to suggest that hCG plays a key role in triggering OHSS and that the syndrome may be more severe and more protracted if pregnancy occurs. Therefore, if signs of ovarian hyperstimulation occur, it is recommended that hCG be withheld and the patient be advised to refrain from coitus or use barrier contraceptive methods for at least 4 days. OHSS develops rapidly; therefore, patients should be followed for at least two weeks after hCG administration. Most often, OHSS occurs after treatment has been discontinued and reaches its maximum severity at seven to ten days following treatment. Usually, OHSS resolves spontaneously with the onset of menses. If there is evidence that OHSS may be developing prior to hCG administration, hCG must be withheld.

When significant risk of OHSS or multiple pregnancies is likely, treatment discontinuation is advised.

If severe OHSS occurs, treatment with gonadotropins must be stopped and the patient should be hospitalized.

A healthcare professional who is experienced in the management of fluid/electrolyte imbalances and/or OHSS should be consulted.

7.1 Special Populations

7.1.1 Pregnant Women

No clinical data on exposed pregnancies are available. No reproduction studies with choriogonadotropin alfa in animals were performed. The rate of miscarriage, in both anovulatory patients and women undergoing assisted reproductive techniques, is higher than that found in the normal population but comparable with the rates observed in women with other fertility problems.

7.1.2 Breast-feeding

It is not known whether this drug is excreted in human milk. Ovidrel is not indicated during breastfeeding.

7.1.3 Pediatrics

Ovidrel is only intended for use in female patients of reproductive age, therefore, safety and effectiveness in pediatric patients has not been established.

7.1.4 Geriatrics

Ovidrel is only intended for use in female patients of reproductive age, therefore, safety and effectiveness in geriatric patients has not been established.

8 ADVERSE REACTIONS

8.1 Adverse Reaction Overview

The safety of Ovidrel was examined in four clinical studies that treated 752 patients of whom 335 received Ovidrel 250 mcg following follicular recruitment with gonadotrophins. When patients enrolled in four clinical studies (1 in ovulation induction and 3 in assisted reproductive technologies) were injected subcutaneously with either Ovidrel or an approved urinary derived hCG, 14.6% (49 of 335 patients) in the Ovidrel 250 mcg group experienced application site disorders compared to 28% (92 of 328 patients) in the approved u-hCG group.

The following adverse reactions have been previously reported during gonadotrophin or menotropin therapy:

- Vascular complications (see 7 WARNINGS AND PRECAUTIONS, Cardiovascular)
- Adnexal torsion (as a complication of ovarian enlargement)
- Mild to moderate ovarian enlargement
- Hemoperitoneum

There have been infrequent reports of ovarian neoplasms, both benign and malignant, in women who have undergone multiple drug regimens for ovulation induction; however, a causal relationship has not been established. During Ovidrel therapy, a minor thyroid stimulation is possible, of which the clinical relevance is unknown. Ectopic pregnancy, ovarian torsion and other complications have been reported in patients after hCG administration. These are considered concomitant effects related to ART.

Ovidrel is used to trigger final follicular maturation and luteinisation for ART, and to achieve ovulation in OI, after use of medicinal products for the stimulation of follicular growth. In this context, it is difficult to attribute undesirable effects to any one of the products used.

8.2 Clinical Trial Adverse Reactions

Clinical trials are conducted under very specific conditions. The adverse reaction rates observed in the clinical trials; therefore, may not reflect the rates observed in practice and should not be compared to the rates in the clinical trials of another drug. Adverse reaction information from clinical trials may be useful in identifying and approximating rates of adverse drug reactions in real-world use.

Adverse events reported for Ovidrel 250 mcg occurring in at least 2% of patients (regardless of causality) are listed in Table 2 for the single OI study.

Table 2: Incidence of Adverse Events of r-hCG in Ovulation Induction (Study 8209)

Body System Preferred Term	Ovidrel 250 mcg (n=99) Incidence Rate % (n)
At Least One Adverse Event	26.2% (26)
Application site disorders	16.2% (16)
Injection site pain	8.1% (8)
Injection site bruising	3.0% (3)
Injection site inflammation	2.0% (2)
Injection site reaction	3.0% (3)
Gastro-intestinal system disorders	4.0% (4)
Abdominal pain	3.0% (3)
Reproductive disorders, female	7.1% (7)
Ovarian cyst	3.0% (3)
Ovarian hyperstimulation	3.0% (3)

Additional adverse events not listed in Table 2 that occurred in less than 2% of patients treated with Ovidrel 250 mcg, whether or not considered causally related to Ovidrel, included: breast pain, flatulence, abdominal enlargement, pharyngitis, upper respiratory tract infection, hyperglycemia and pruritis.

In three studies involving 236 patients treated with Ovidrel 250 mcg and undergoing assisted reproductive technologies (Studies 7648, 7927 and 9073 – Chang, 2001), at least one adverse event was observed in 78 patients (33.1%). Application site disorders occurred in 14.0% of patients, which included injection site pain in 7.6% and injection site bruising in 4.7% of subjects. Twenty patients (8.5%) experienced gastro-intestinal system disorders, and these events included abdominal pain (4.2%), nausea (3.4%) and vomiting (2.5%). Post-operative pain was noted by 4.7% of patients participating in the studies.

Adverse events that occurred in less than 2% of patients treated with Ovidrel 250 mcg, whether or not considered causally related to Ovidrel, included: injection site inflammation and reaction, flatulence, diarrhea, hiccup, ectopic pregnancy, breast pain, intermenstrual bleeding, vaginal hemorrhage, vaginal discharge, cervical lesion, ovarian hyperstimulation, uterine disorders, vaginitis, vaginal discomfort, body pain, back pain, fever, dizziness, headache, hot flashes, malaise, paraesthesia, rash, emotional lability, insomnia, upper respiratory tract infection, cough, dysuria, urinary tract infection, urinary incontinence, albuminuria, cardiac arrhythmia, genital moniliasis, genital herpes, leukocytosis, heart murmur and cervical carcinoma.

The following medical events have been reported subsequent to pregnancies resulting from hCG therapy in controlled clinical studies:

- Spontaneous Abortion
- Ectopic Pregnancy
- Premature Labor
- Postpartum Fever
- Congenital abnormalities

Of 125 clinical pregnancies reported following treatment with FSH and Ovidrel 250 mcg or 500 mcg, three were associated with a congenital anomaly of the fetus or newborn. Among patients receiving Ovidrel 250 mcg, cranial malformation was detected in the fetus of one woman and a chromosomal abnormality (47, XXX) in another. These events were judged by the investigators to be of unlikely or unknown relation to treatment. These three events represent an incidence of major congenital malformations of 2.4%, which is consistent with the reported rate for pregnancies resulting from natural or assisted conception. In a woman who received Ovidrel 500 mcg, one birth in a set of triplets was associated with Down's syndrome and atrial septal defect. This event was considered to be unrelated to the study drug.

After best evidence assessment, the following undesirable effects may be observed after administration of Ovidrel:

Common (>1/100, < 1/10)

Application site disorders: Local reaction/pain at injection site

Nervous system disorders: Headache, tiredness

Gastro-intestinal system disorders: Vomiting/nausea, abdominal pain, abdominal distension

Reproductive disorders: Mild or moderate OHSS

8.3 Less Common Clinical Trial Adverse Reactions

Uncommon (>1/1000, <1/100)

Reproductive disorders: Severe OHSS, breast pain

Gastrointestinal disorders: Abdominal discomfort, diarrhoea

8.5 Post-Market Adverse Reactions

Immune system disorders: Mild to severe hypersensitivity reactions including rash, anaphylactic reactions and shock

Vascular disorders: Very rare (1/10,000) thromboembolism (both in association with and separate from OHSS)

9 DRUG INTERACTIONS

No clinically significant drug interactions have been reported during hCG therapy. Following administration, Ovidrel may interfere for up to ten days with the immunological determination of serum / urinary hCG, leading to a false positive pregnancy test.

10 CLINICAL PHARMACOLOGY

10.1 Mechanism of Action

Ovidrel (choriogonadotropin alfa) is a sterile solution in pre-filled syringe or in pre-filled pen for injection preparation of choriogonadotropin alfa (recombinant human Chorionic Gonadotrophin, r-hCG). The drug substance is produced by recombinant DNA techniques. Choriogonadotropin alfa is a water-soluble glycoprotein consisting of two non-covalently linked subunits – designated α and β – consisting of 92 and 145 amino acid residues, respectively, with carbohydrate moieties linked to ASN-52 and ASN-78 (on alpha subunit) and ASN-13, ASN-30, SER-121, SER-127, SER-132 and SER-138 (on beta subunit). The primary structure of the α -chain of r-hCG is identical to that of the α -chain of hCG, FSH and LH. The glycoform pattern of the α -subunit of r-hCG is closely comparable to urinary derived hCG (u-hCG), the differences mainly being due to the branching and salicylation extent of the oligosaccharides. The β -chain has both O- and N-glycosylation sites and its structure and glycosylation pattern are also very similar to that of u-hCG.

The production process involves expansion of genetically modified Chinese Hamster Ovary (CHO) cells from an extensively characterized cell bank into large scale cell culture processing. Choriogonadotropin alfa is secreted by CHO cells directly into the cell culture medium, which is then purified using a series of chromatographic steps. This process yields a product with a high level of purity and consistent product characteristics including glycoforms and biological activity. The biological activity of choriogonadotropin alfa is determined using the seminal vesicle weight gain test in male rats described in the “Chorionic Gonadotrophins” monograph of the European Pharmacopoeia. The in vivo biological activity of choriogonadotropin alfa has been calibrated against the third international reference preparation IS75/587 for chorionic gonadotrophin.

The physicochemical, immunological, and biological activities of recombinant hCG are comparable to those of placental and human pregnancy urine-derived hCG. Choriogonadotropin alfa stimulates late follicular maturation and resumption of oocyte meiosis, and initiates rupture of the pre-ovulatory ovarian follicle. Choriogonadotropin alfa, the active component of Ovidrel, is an analogue of Luteinizing Hormone (LH) and binds to the LH/hCG receptor of the granulosa and theca cells of the ovary to effect these changes in the absence of an endogenous LH surge. In pregnancy, hCG, secreted by the placenta, maintains the viability of the corpus luteum to provide the continued secretion of estrogen and progesterone necessary to support the first trimester of pregnancy. Ovidrel is administered when monitoring of the patient indicates that sufficient follicular development has occurred in response to follicle stimulating agent treatment for ovulation induction.

10.2 Pharmacodynamics

ANIMAL

The in vivo and in vitro experiments have shown that r-hCG has the same binding affinity to the LH/hCG receptor on MA 10 cells as u-hCG, it stimulates progesterone production by those cells with the same potency as u-hCG and several national and international reference standards, it had the same potency as several reference standards and u-hCG in Ph. Eur. and USP bioassays in the rat, and, in a detailed test in the primed adult female rhesus monkey, r- and u-hCG stimulated the production of oocytes of the same maturity, and exerted the same hormonal activities on luteinisation of ovarian follicles. The time course of the actions of r-hCG and u-hCG were identical in the in vivo studies.

Taken together, these results show the quantitative, functional identity of r-hCG and u-hCG by a number of independent means. The experiment in the rhesus monkey has also demonstrated that r-hCG has the intended pharmacodynamic action as it was a close model of its clinical use to induce ovulation and to produce oocytes of sufficient maturity to be capable of being fertilized.

With regards to the general pharmacology, r-hCG had no particular effect on the functioning of the cardiovascular and respiratory systems.

These findings were also supported by the acute toxicity tests which did not indicate any action on the CNS or PNS, and the lack of clinical signs in those experiments and the repeat dose toxicity tests is a reasonable indication that r-hCG does not affect smooth muscle or the gastrointestinal tract.

All these findings together permit a reasonable assessment of the general pharmacological actions of r-hCG. It does not exhibit actions of this type that suggest a risk to humans.

10.3 Pharmacokinetics

The pharmacokinetics of Ovidrel was studied in healthy male and female volunteers both after intravenous and subcutaneous administration.

Pharmacokinetic parameter estimates following single SC administration of Ovidrel to males and females are presented in Table 3.

Table 3 - Pharmacokinetic Parameters (mean \pm SD) of r-hCG after Single 250 mcg Subcutaneous Dose of Ovidrel in Healthy Male and Female Volunteers (IMP23286)

Pharmacokinetic Parameter	Single dose @ 250 mcg Liquid (IMP23286)	
	Male	Female
C_{max} (mcg/L)	5.62 \pm 1.54	7.10 \pm 2.99
T_{max} (h) *	16 (9-48)	22 (12-48)
AUC (h*mcg/L)	498 \pm 129	560 \pm 148
$T_{1/2}$ (h)	40 \pm 4	37 \pm 6

C_{max} : peak concentration (above baseline), t_{max} : time of C_{max} , AUC: total area under the curve, $t_{1/2}$: apparent elimination half-life, * median (range)

Absorption

Following a single subcutaneous administration of Ovidrel 250 mcg to healthy female volunteers (IMP23286), the maximum serum concentration (7.10 ± 2.99 mcg/L) is reached after approximately 12 to 48 hours. The mean absolute bioavailability of Ovidrel following a single subcutaneous injection to healthy female volunteers at the dose of 132 mcg (GF7013) is about 40%.

Distribution

Following a single intravenous administration of Ovidrel 270 mcg to healthy female volunteers (GF7012), the serum profile of hCG is described by a two-compartment model with a distribution half-life of 4.5 ± 0.5 hours. The steady state volume of distribution is 5.8 ± 1.0 L.

Following repeated subcutaneous administration of Ovidrel 132 mcg to healthy female volunteers (one administration every 48 hours, GF7013), the accumulation ratio is 1.61 ± 0.40 .

Metabolism/Elimination

After a single intravenous administration of Ovidrel 270 mcg to healthy female volunteers (GF7012), the mean terminal half-life is 27 ± 3 hours and the total body clearance is 0.29 ± 0.04 L/h. The exposure is linear in the range 25 – 1000 mcg. One-tenth of the dose is excreted in the urine. After single subcutaneous administration of Ovidrel 250 mcg to healthy female volunteers (IMP23286), the apparent terminal half-life is 37 ± 6 hours.

11 STORAGE, STABILITY AND DISPOSAL

Refer to the date indicated on the labels for the expiry date. Do not use after expiry date.

Do not freeze. Store in the original package. Protect from light.

Ovidrel in pre-filled syringes are to be stored at 2 to 8°C (in a refrigerator). The patient may store the pre-filled syringe at 25°C (room temperature) for up to 30 days, however after this time the pre-filled syringe should be discarded.

Ovidrel in pre-filled pens are to be stored at 2 to 8°C (in a refrigerator).

Use the needle and pen only once. Discard the pen. When the pen is empty, ask your pharmacist how to dispose of it.

Important note: Medicines should not be disposed of via wastewater or household waste.

12 SPECIAL HANDLING INSTRUCTIONS

Not applicable

PART II: SCIENTIFIC INFORMATION

13 PHARMACEUTICAL INFORMATION

Drug Substance

Proper name: Choriogonadotropin alfa for injection

Chemical name: Not applicable

Molecular mass: 70kDa

Structural formula: The full amino acid sequence is as follows:

The α -subunit:

Ala-Pro-Asp-Val-Gln-Asp-Cys-Pro-Glu-Cys-Thr-Leu-Gln-Glu-Asn-Pro
Phe-Phe-Ser-Gln-Pro-Gly-Ala-Pro-Ile-Leu-Gln-Cys-Met-Gly-Cys-Cys
Phe-Ser-Arg-Ala-Tyr-Pro-Thr-Pro-Leu-Arg-Ser-Lys-Lys-Thr-Met-Leu
Val-Gln-Lys-Asn-Val-Thr-Ser-Glu-Ser-Thr-Cys-Cys- Val-Ala-Lys-Ser
Tyr-Asn-Arg-Val-Thr-Val-Met-Gly-Gly-Phe-Lys-Val-Glu-Asn-His-Thr
Ala-Cys-His-Cys-Ser-Thr-Cys-Tyr-Tyr-His-Lys-Ser

The β -subunit:

Ser-Lys-Glu-Pro-Leu-Arg-Pro-Arg-Cys-Arg-Pro-Ile-Asn-Ala-Thr-Leu
Ala-Val-Glu-Lys-Glu-Gly-Cys-Pro-Val-Cys-Ile-Thr-Val-Asn-Thr-Thr-Ile
Cys-Ala-Gly-Tyr-Cys-Pro-Thr-Met-Thr-Arg-Val-Leu-Gln-Gly-Val-Leu
Pro-Ala-Leu-Pro-Gln-Val-Val-Cys-Asn-Tyr-Arg-Asp-Val-Arg-Phe-Glu
Ser-Ile-Arg-Leu-Pro-Gly-Cys-Pro-Arg-Gly-Val-Asn-Pro-Val-Val-Ser-Tyr
Ala-Val-Ala-Leu-Ser-Cys-Gln-Cys-Ala-Leu-Cys-Arg-Arg-Ser-Thr-Thr
Asp-Cys-Gly-Gly-Pro-Lys-Asp-His-Pro-Leu-Thr-Cys-Asp-Asp-Pro-Arg
Phe-Gln-Asp-Ser-Ser-Ser-Ser-Lys-Ala-Pro-Pro-Pro-Ser-Leu-Pro-Ser-Pro
Ser-Arg-Leu-Pro-Gly-Pro-Ser-Asp-Thr-Pro-Ile-Leu-Pro-Gln

Physicochemical properties: pH - 6.5-7.5

Bioactivity - A dose of 250 mcg is equivalent to approximately 6,500 IU

Pharmaceutical standard: Manufacturer's

14 CLINICAL TRIALS

14.1 Trial Design and Study Demographics

The safety and efficacy of Ovidrel have been examined in four well-controlled studies in women; three studies for assisted reproductive technologies and one study for ovulation induction (OI).

Table 4 - Summary of patient demographics for clinical trials in Ovidrel

Study #	Study design	Dosage, route of administration and duration	Study subjects (n)	Sex
8209	Double-blind, randomized, multicenter study in anovulatory infertile women	Ovidrel 250 mcg administered subcutaneously versus 5,000 IU of an approved urinary-derived hCG product administered subcutaneously	242	Female

The safety and efficacy of Ovidrel 250 mcg administered subcutaneously versus 5,000 IU of an approved urinary-derived hCG product administered subcutaneously were assessed in a double-blind, randomized, multicenter study in anovulatory infertile women (Study 8209) which was conducted in 19 centers in Australia, Canada, Europe, Switzerland and Israel. The primary efficacy parameter in this single-cycle study was the patient ovulation rate. 242 patients entered the study, of whom 99 received Ovidrel 250 mcg.

14.2 Study Results

The efficacy of Ovidrel 250 mcg was found to be clinically and statistically equivalent to that of the approved urinary-derived hCG product. The results of those patients who received Ovidrel 250 mcg are summarized in Table 5.

Table 5 - Efficacy Outcomes of r-hCG in OI (Study 8209)

Parameter	Ovidrel 250 mcg (n = 99)
Ovulation Rate	91 (91.9%)
Clinical Pregnancy Rate [†]	22 (22%)

[†] Clinical pregnancy, defined as a pregnancy during which a fetal sac (with or without heartbeat activity) was detected by ultrasound on day 35-42 after hCG administration.

For the 22 patients who had a clinical pregnancy with Ovidrel 250 mcg, the outcome of the pregnancy is presented in Table 6.

Table 6 - Pregnancy Outcomes of r-hCG in OI (Study 8209)

Parameter	Ovidrel 250 mcg (n = 22)
Clinical pregnancies not reaching term	7 (31.8%)
Live births	15 (68.2%)
<i>Singleton</i>	13 (86.7%)
<i>Multiple birth</i>	2 (13.3%)

The trials demonstrated that the 250 mcg dose of Ovidrel was associated with a lower risk of OHSS, while the 500 mcg dose of Ovidrel was significantly more stimulatory to the ovary than the lower dose. However, there was no demonstrable benefit in terms of pregnancy or pregnancy outcome.

16 NON-CLINICAL TOXICOLOGY

General Toxicology:

Recombinant hCG had almost no effect in the single dose studies apart from the predictable pharmacological action on the gonads in the sexually mature rat. The occurrence of antibodies in animals is of no concern as the protein is of human type and will therefore be treated as a foreign antigen.

The subacute tests in the monkey and rat have shown only the anticipated endocrine effects of high doses of this potent gonadotrophin, including some of the known oestrogenic actions in the rat. Antibodies were formed after a few weeks both in the rat and monkey, which greatly accelerated clearance of the injected r-hCG but did not completely reverse the endocrine actions during continued dosing. The effects all disappeared completely or almost so during the 4-week recovery period. There was almost no reaction at the injection sites.

Administration of r-hCG at up to 5,000 U (250 mcg)/kg/d, s.c. for up to 26 weeks, to sexually mature male Cynomolgus monkeys, of u-hCG 500 U/kg/d s.c. again for 26 weeks and of up to 20,000 U (1,000 mcg)/kg/d s.c. to the rat for up to 4 weeks, has not revealed any specific toxic actions.

There have been extensive pharmacodynamic actions, due both to the direct effect of the hCGs and, in the longer term experiments, to the secondary actions of the stimulated production of testosterone in males and oestrogens in females (rats only), always in a dose-related manner. They have comprised effects on body growth in the monkey, on the male and female gonads in both species, and on the pituitary and certain secondary sex organs in both sexes. When assessed after the 4-week studies, the actions have been largely reversed.

The injection sites showed only slight inflammatory cell infiltration. In the 26-week test, the production, morphology and functionality of sperm were normal. In the monkey, serum antibodies to r- and u-hCG appeared in a dose related manner, more often after s.c. than i.v. dosing, usually becoming detectable after about 2 weeks, and being present in most or all animals after 4-12 weeks. Despite their presence, the effects of the hCGs were maintained and serum levels could still be measured even after 26 weeks.

Given that a heterologous protein has been tested, albeit in responsive species, it is apparent that r-hCG has the same biological actions as u-hCG in these experiments, that it lacks any conventional target organ toxicity, and that antibody formation has not led either to neutralisation of its actions or to immune complex disease.

The overall pattern of toxicity findings, therefore, is that of high dose pharmacodynamic actions under circumstances remote from human experience, and with the same actions occurring after the new r-hCG and the identical u-hCG, which is already well-studied and has been extensively used by patients for many years.

The extent of our knowledge of the effects of u-hCG in humans is a good reason why the lack of a formal chronic toxicity test in the rodent does not represent a serious weakness in the studies of r-hCG. Further the present application is only for a single-dose administration per fertility treatment, and women undergo only a limited number of fertility treatments.

Carcinogenicity: No carcinogenicity studies were conducted on r-hCG.

Genotoxicity: A full set of genotoxicity tests including bacteria (*S. typhimurium* and *E. Coli*) and mammalian cell lines (Chinese hamster lung cells), chromosome aberration assay in human lymphocytes and in vivo mouse micronucleus test, was done on r-hCG and the results were uniformly negative.

Reproductive and Developmental Toxicology: No reproductive and developmental toxicity studies were conducted on r-hCG.

PATIENT MEDICATION INFORMATION

READ THIS FOR SAFE AND EFFECTIVE USE OF YOUR MEDICINE

Pr OVIDREL®

choriogonadotropin alfa

Read this carefully before you start taking **Ovidrel** and each time you get a refill. This leaflet is a summary and will not tell you everything about this drug. Talk to your healthcare professional about your medical condition and treatment and ask if there is any new information about **Ovidrel**.

What is Ovidrel used for?

Ovidrel is indicated for women following the stimulation phase of infertility treatment. Ovidrel is used to trigger ovulation in infertile women with ovarian dysfunction.

How does Ovidrel work?

Ovidrel is the only recombinant human chorionic gonadotrophin (r-hCG). Its generic name is choriogonadotropin alfa. hCG, is a hormone that is involved in reproduction in women. It is found in the urine of pregnant women and is produced by the placenta. Ovidrel is produced as a solution in a pre-filled syringe or a pre-filled pen that is intended for subcutaneous injection. Ovidrel ensures that you are receiving the highest purity hCG on the market. Subcutaneous injections offer the advantage of being convenient and easy to self-administer.

What are the ingredients in Ovidrel?

Medicinal ingredients: Pre-filled Syringe and Pre-filled - choriogonadotropin alfa

Non-medicinal ingredients:

Prefilled Syringe - L-methionine, Mannitol, Phosphoric acid, Poloxamer 188, Sodium hydroxide, Water for injection

Prefilled Pen: Disodium hydrogen phosphate dihydrate, L-methionine, Mannitol, Phosphoric acid, Poloxamer 188, Sodium dihydrogen phosphate monohydrate, Sodium hydroxide, Water for injection.

Ovidrel comes in the following dosage forms:

Ovidrel comes in two formats: 250 mcg in a pre-filled pen or 250 mcg in 0.5 ml for the ready to use solution packaged in a pre-filled syringe.

Do not use Ovidrel if:

- if you are allergic to choriogonadotropin alfa or any of the other ingredients of this medicine.
- if you have a tumour in your hypothalamus or pituitary gland (both are parts of the brain).
- if you have large ovaries or sacs of fluid within the ovaries (ovarian cysts) of unknown origin.
- if you have unexplained vaginal bleeding.
- if you have cancer of your ovaries, womb or breast.
- if you have severe inflammation of your veins or blood clotting in your veins (active thromboembolic disorders).
- if you have any condition that usually makes a normal pregnancy impossible, such as menopause or early menopause (ovarian failure), or malformations of sexual organs.
- if you have an uncontrolled thyroid or adrenal function.
- if your ovaries stop functioning.

- If you are currently pregnant.

Other warnings you should know about:

- A higher risk of a blood clot

When undergoing assisted reproductive technologies or stimulation of your ovaries to produce eggs, there may be a higher occurrence of a miscarriage or pregnancy outside of the womb (ectopic pregnancy) than the average woman.

Reports of multiple births have been associated with fertility treatments. You should discuss the potential risk of multiple births with your healthcare professional before beginning treatment.

To help avoid side effects and ensure proper use, talk to your healthcare professional before you take Ovidrel. Talk about any health conditions or problems you may have, including if you have:

- Severe pain
- Bloating in the stomach
- Bloating in the pelvic area
- Severe upset stomach
- Vomiting
- Weight gain

Contact your healthcare professional if you have any of these signs or symptoms. These are symptoms of a medical event called Ovarian Hyperstimulation Syndrome (OHSS). OHSS occurs infrequently (usually less than 3% incidence). However, because OHSS can progress rapidly to a serious medical event, Ovidrel should be stopped at the first signs of OHSS.

There is no evidence to establish an association between the administration of Ovidrel to female patients and the occurrence of congenital anomalies in their offspring. The data supporting this position is derived from the conclusions of clinical trials, as well as from post-marketing information where no cases of congenital anomalies have been reported since the introduction of Ovidrel to the market. Moreover, based on large epidemiological studies published in the literature, the rate of major or minor congenital anomalies following assisted reproductive technology procedures is consistent with that found in the unassisted population. It must be noted that these epidemiological studies relate to clinical trials carried out with urinary drugs. There is, however, no ground to suspect that, with regards to this particular risk, the recombinant product would be different from similar drugs of urinary origin.

Tell your healthcare professional about all the medicines you take, including any drugs, vitamins, minerals, natural supplements or alternative medicines.

The following may interact with Ovidrel:

Please inform your healthcare professional and pharmacist if you are taking or have taken any other medications, even those not requiring a prescription.

How to take Ovidrel:

Ovidrel (choriogonadotropin alfa) offers the ease of use and convenience available with subcutaneous administration. Please familiarize yourself with the following instructions in order to understand how to self-administer Ovidrel.

Directions for Administration of Ovidrel in Pre-filled Syringe

OVIDREL in pre-filled syringes is intended for a single subcutaneous injection. Any unused material should be discarded. Ask your health care provider on how to dispose of used syringes and medicines no longer required. Ovidrel may be self-administered by the patient.

Follow the directions below for injecting Ovidrel

Step 1: Getting ready

On a clean work surface, lay out the items listed below before you begin:

- One Ovidrel pre-filled syringe
- Alcohol wipes (not supplied with the product)
- Sharps disposal container (not supplied with the product)

Step 2: Cleanse

- Wash your hands thoroughly with soap and water.
- It is important that your hands and the items you use be as clean as possible.
- Needles should not touch any surface except alcohol-cleaned skin; keep them capped prior to use.

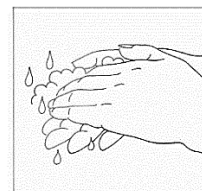

Step 3: Prepare Injection Site

- Select the site of injection (e.g. top of thigh, tummy). Refer to the injection site diagram.
- Wipe the chosen area with an alcohol wipe, cleansing an area of approximately 5 cm x 5 cm. Lay the used side of the wipe next to your working surface or on the alcohol wipe wrapper.
- Pick up the syringe and remove the cap from the needle.
- Invert the needle and hold as if “throwing a dart”. With your other hand, gently squeeze the skin together to make a little elevation at the injection site. Using a “dart like motion”, insert the needle at a 90 degree angle. (You need very little force but quick action.)
- Once the needle is inserted into the tissue all the way, inject the solution by pushing gently on the plunger with your thumb of the hand holding the syringe. Take as much time as you need to inject all the solution.
- Immediately withdraw the needle and clean the site with the clean side of the alcohol wipe using a circular motion. If there is minor oozing you may need to apply a small amount of pressure for a minute.

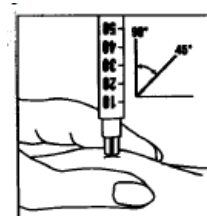

Step 4: Disposal of used Items

Once you have finished your injection, immediately discard the needles and syringe (without recapping the needle) into the disposal container. Take the container to a clinic or pharmacy for proper disposal.

Directions for Administration of Ovidrel in Pre-filled Pen

- This section tells you how to use your pen.

- Do not share the pen. The pen is for subcutaneous injection only.
- Inject Ovidrel as your healthcare professional has taught you.
- **This pen is for single use only.**
- **Please read these directions for use before using your Ovidrel Pen. Follow the procedure exactly, as it may differ from your past experience.**

Ovidrel Pen, and other materials you may need for injection:

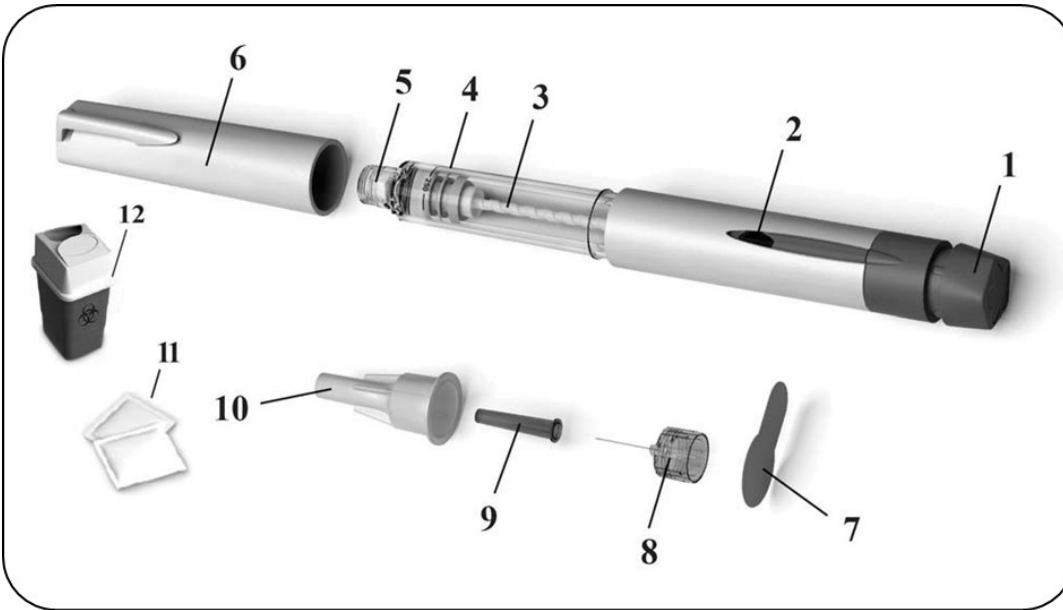

- | | | | |
|----|---------------------------|-----|---|
| 1. | Dose Setting Knob | 7. | Peel off seal tab |
| 2. | Dose Display | 8. | Removable needle |
| 3. | Plunger piston | 9. | Inner needle shield |
| 4. | Reservoir holder | 10. | Outer needle cap |
| 5. | Threaded needle connector | 11. | Alcohol wipes (not supplied with the product) |
| 6. | Pen cap | 12. | Sharps disposal container (not supplied with the product) |

Follow the directions below for injecting Ovidrel

1. Before you start using your Ovidrel Pen

- Wash your hands with soap and water. It is important that your hands and the items you use be as clean as possible.



- On a clean surface, e.g., clean table or kitchen surface, lay out everything you will need:

- Ovidrel Pen
- One removable injection needle
- Alcohol wipes (not supplied with product)
- Sharps disposal container (not supplied with product)
- Verify the **expiration date** on the pen label. Do not use expired medication.



2. Getting your Ovidrel Pen ready for injection

- Take off the pen cap.
- Wipe the end of the threaded tip (containing the rubber center) using an alcohol wipe.
- Look carefully at the reservoir holder. Check that the reservoir holder is not cracked and that the solution is clear and does not contain particles. If the reservoir holder is cracked or if the solution is discoloured or cloudy, obtain a new pen.
- Verify that the Dose Display is set to “0”.

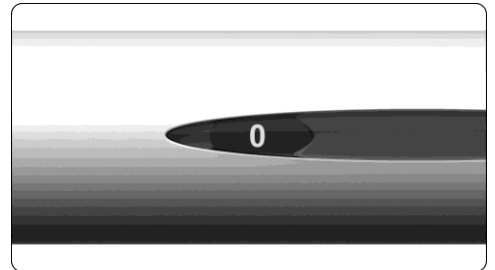
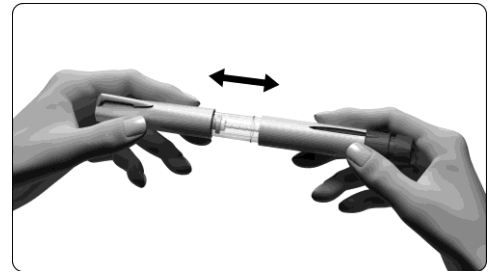

- Prepare your needle for injection:
 - Get a new needle – only use the ‘single use’ needles supplied for the Ovidrel Pen.
 - Hold the outer needle cap firmly.
 - Check that the peel-off seal on the outer needle cap is not damaged or loose. If it is damaged or loose, do not use the needle and get another. Throw away the unused needle with the outer needle cap still on, in a sharps container.



- Remove peel-off seal.



3. Attach the needle

- Press the threaded tip of the Ovidrel Pen into the outer needle cap and twist it clockwise until you feel a light resistance.
- **Important Note:** Do not attach the needle too tightly; the needle could be difficult to remove after the injection.



- Remove the outer needle cap by pulling it straight off.

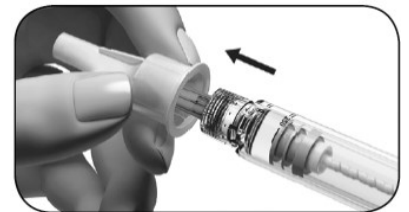

- Put it aside for later use.
- Do not throw away the outer needle cap; you will need it for removing the needle from the pen.

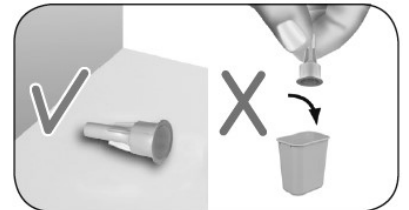

- Hold the Ovidrel Pen with the needle pointing upward.
- Carefully remove and discard the inner green shield.

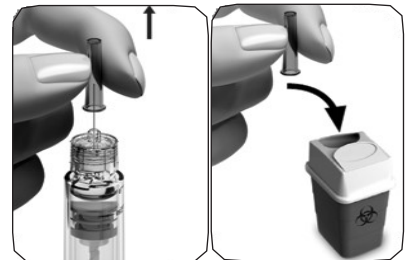

- Look closely at the tip of the needle for tiny drop(s) of fluid. If you see a tiny drop(s) of fluid, proceed to Section 4: **Setting the dose to 250.**

Caution: If you do not see a tiny drop(s) of fluid at or near the needle tip, you must perform the steps below:

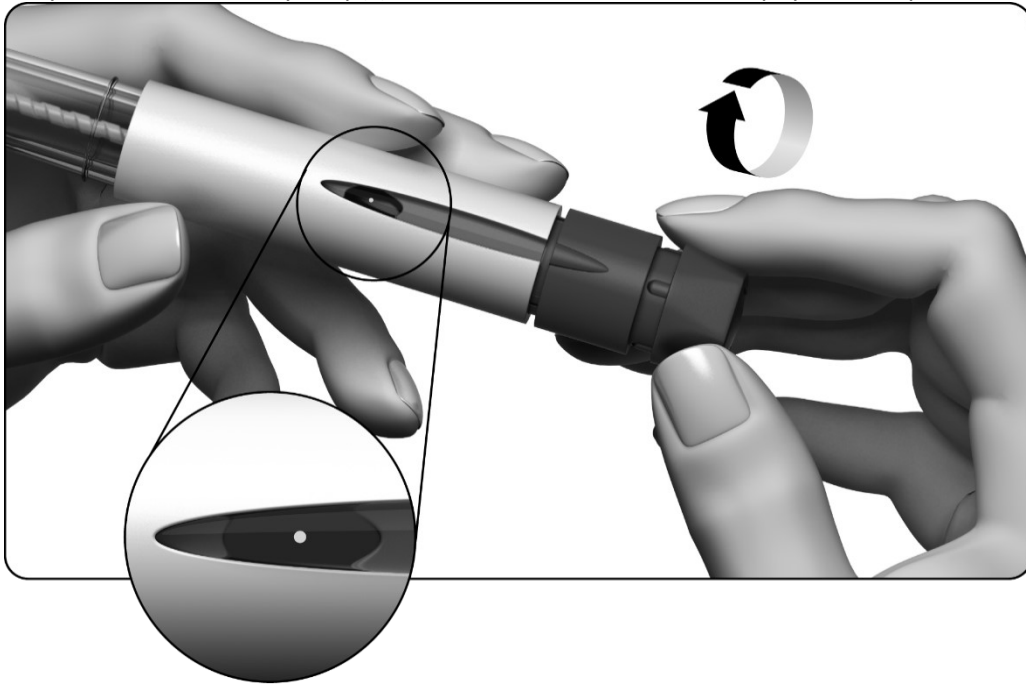

1. Gently turn the Dose Setting Knob clockwise until you see a dot (●) in the Dose Display. If you pass this position, simply turn the Dose Setting Knob back to the dot (●).
2. Hold the pen with the needle pointing upwards.
3. Tap the reservoir holder gently.
4. Press the Dose Setting Knob as far as it will go. A tiny drop of liquid will appear at the top of the needle; this shows that your prefilled pen is ready for injection.
5. If you do not see any liquid, you may try a second time (you may do this a maximum of two times) starting from Step 1 of this section “If you do not see a tiny drop of fluid at or near the needle tip” above.

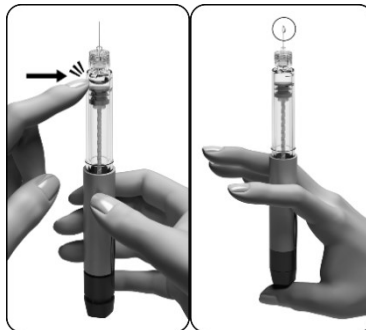

4. Setting the dose to 250

- Gently turn the Dose Setting Knob clockwise. The Dose Display will show a straight line and you have to keep turning until you can read the number “250”.
- Do not push or pull the dose setting button while you turn it.

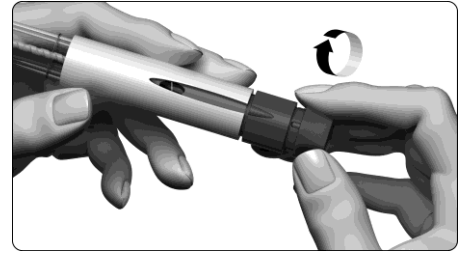

- If not already done while removing air, carefully remove the inner needle shield.
- Check that the Dose Display shows “250” before you move on to the next step.

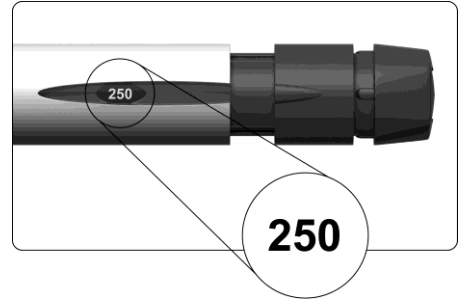

5. Injecting your dose

- Choose the place to give the injection where your healthcare professional or nurse has told you – usually on your upper thighs or abdomen.

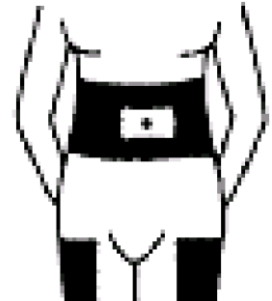

- Clean the skin by wiping the area with an alcohol wipe. Allow the site to dry.
- Lay the used side of the alcohol wipe to the side.
- Verify once more that the Dose Display reads “250”. If it does not, you must adjust it (see step 4. **Setting your dose to 250**).
- Inject the dose as you were told to by your healthcare professional or nurse.
- Holding the pen in one hand, use your other hand to gently squeeze the skin together to make a raised area at the injection site. Slowly push the needle into the skin (1).
- Insert the needle at a 90° angle into the skin. You might bend the needle if you do not insert it at a 90° angle.
- Place your thumb in the middle of the dose setting knob.
- Slowly press the Dose Setting Knob down as far as it will go and hold it to complete the full injection.

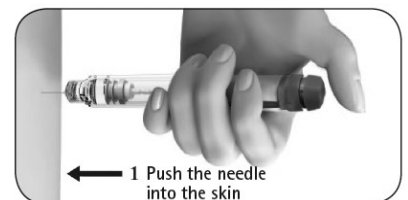

- Hold the Dose Setting Knob down for a minimum of 5 seconds to ensure you inject the full dose (2). **Do not release the Dose Setting Knob until you remove the needle from your skin.**
- Remove the needle from your skin (3), release the Dose Setting Knob.
- The dose number shown in the Dose Display will turn back to “0”. This shows that the complete dose was delivered.
- Use the clean side of the alcohol wipe to gently apply pressure where you have just injected.

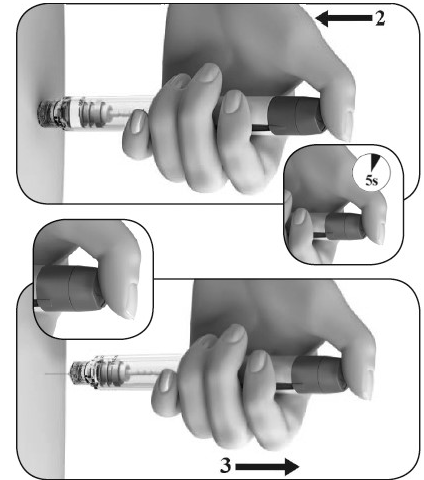

6. After the injection

- Verify you have given a complete injection.
- Check that the Dose Display reads “0”.
- This confirms that your dose has been fully delivered. **Do not attempt to inject a second time.**
- **In case the Dose Display doesn't show “0”, please contact your healthcare professional.**

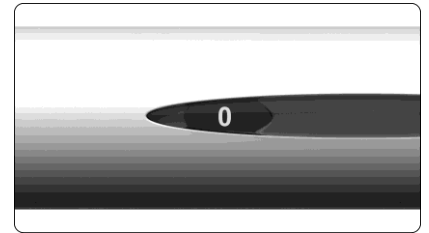

7. Removing the needle after injection

- Hold the pen firmly by the reservoir holder.
- Carefully put the outer needle cap back onto the needle. Be careful not to prick yourself with the needle.
- Grip the outer needle cap and unscrew the needle by turning the cap counter clockwise. Dispose of the used needle safely.

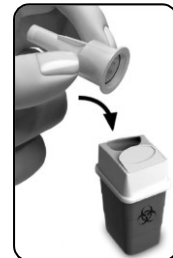
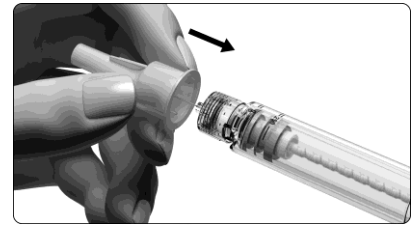

8. Disposal

- Use the needle and pen only once.
- Discard the pen.
- When the pen is empty, ask your pharmacist how to dispose of it.
Important note: Medicines should not be disposed of via wastewater or household waste.

If you have any further questions on the use of this medicine, ask your healthcare professional or pharmacist.

Usual dose:

Ovidrel should not be administered until adequate follicular development is indicated by serum estradiol and/or vaginal ultrasonography

Ovidrel 250 mcg should be administered subcutaneously one day following the last dose of the follicle stimulating agent. Ovidrel administration should be withheld in situations where there is an excessive ovarian response, as evidenced by multiple follicular development, clinically significant ovarian enlargement or excessive estradiol production.

Overdose:

No case of overdose has been reported. Nevertheless, there is a possibility that OHSS may result from an overdose of Ovidrel.

If you think you, or a person you are caring for, have taken too much Ovidrel, contact a healthcare professional, hospital emergency department, or regional poison control centre immediately, even if there are no symptoms.

What are possible side effects from using Ovidrel?

These are not all the possible side effects you may have when taking Ovidrel. If you experience any side effects not listed here, tell your healthcare professional.

The following side effects have been reported with the use of Ovidrel:

- Discomfort at the injection site
- Stomach pain
- Nausea
- Vomiting

Ask your fertility team to discuss the possible side effects with you. As with all medications, it is important to report any physical changes and all symptoms to your healthcare professional.

If you have a troublesome symptom or side effect that is not listed here or becomes bad enough to interfere with your daily activities, tell your healthcare professional.

Reporting Side Effects

You can report any suspected side effects associated with the use of health products to Health Canada by:

- Visiting the Web page on Adverse Reaction Reporting (<https://www.canada.ca/en/health-canada/services/drugs-health-products/medeffect-canada.html>) for information on how to report online, by mail or by fax; or
- Calling toll-free at 1-866-234-2345.

NOTE: Contact your health professional if you need information about how to manage your side effects. The Canada Vigilance Program does not provide medical advice.

Storage:

- Refer to the date indicated on the labels for the expiry date. Do not use after expiry date.
- Do not freeze. Store in the original package. Protect from light.
- Do not use the Ovidrel pre-filled syringe or pre-filled pen if the solution contains particles or is not clear.
- Ovidrel in pre-filled syringes are to be stored at 2 to 8°C (in a refrigerator). The patient may store the pre-filled syringe at 25°C (room temperature) for up to 30 days, however after this time the pre-filled syringe should be discarded.
- Ovidrel in pre-filled pens are to be stored at 2 to 8°C (in a refrigerator).
- Keep out of reach and sight of children.

If you want more information about Ovidrel:

- Talk to your healthcare professional
- Find the full product monograph that is prepared for healthcare professionals and includes this Patient Medication Information by visiting the Health Canada website: (<https://www.canada.ca/en/health-canada/services/drugs-health-products/drug-products/drug-product-database.html>); the manufacturer's website <https://medinfo.emdserono.ca/en>, or by calling 1-800-387-8479.

OVIDREL® is a trademark of Merck KGaA, Darmstadt, Germany or its affiliates.

This leaflet was prepared by EMD Serono, a Division of EMD Inc., Canada.

Last Revised Oct 12, 2023