

PRODUCT MONOGRAPH  
INCLUDING PATIENT MEDICATION INFORMATION

Pr DUPIXENT®

dupilumab injection

solution for subcutaneous injection

300 mg single-use syringe (300 mg/2 mL)

300 mg single-use pen (300 mg/2 mL)

200 mg single-use syringe (200 mg/1.14 mL)

200 mg single-use pen (200 mg/1.14 mL)

Immunomodulator, Interleukin inhibitor

ATC code: D11AH05

Sanofi-aventis Canada Inc.  
1755 Steeles Avenue West  
Toronto, ON  
M2R 3T4

Date of Initial Authorization:  
Nov 30, 2017

Date of Revision:  
Mar 14, 2024

Distributed by Sanofi Genzyme,  
a division of sanofi-aventis Canada Inc.  
1755 Steeles Avenue West  
Toronto, ON  
M2R 3T4

Submission Control Number: 280565

## RECENT MAJOR LABEL CHANGES

1 Indications	07/2023
4 Dosage and Administration, 4.2 Recommended Dose and Dosage Adjustment, 4.3 Administration	07/2023
1 Indications	05/2023
4 Dosage and Administration, 4.2 Recommended Dose and Dosage Adjustment	05/2023
4 Dosage and Administration, 4.3 Administration	05/2023
1 Indications	04/2023
1 Indications, 1.1 Pediatric	04/2023
4 Dosage and Administration, 4.2 Recommended Dose and Dosage Adjustment	04/2023
4 Dosage and Administration, 4.3 Administration	04/2023
1 Indications	03/2022
1 Indications, 1.1 Pediatric	03/2022
4 Dosage and Administration, 4.2 Recommended Dose and Dosage Adjustment	03/2022
4 Dosage and Administration, 4.3 Administration	03/2022
7 Warnings and Precautions, 7.1.3 Pediatrics	03/2022
7 Warnings and Precautions	03/2022

## TABLE OF CONTENTS

*Sections or subsections that are not applicable at the time of authorization are not listed.*

<b>RECENT MAJOR LABEL CHANGES</b> .....	<b>2</b>
<b>TABLE OF CONTENTS</b> .....	<b>2</b>
<b>PART I: HEALTH PROFESSIONAL INFORMATION</b> .....	<b>5</b>
<b>1. INDICATIONS</b> .....	<b>5</b>
1.1 Pediatrics .....	5
1.2 Geriatrics.....	6
<b>2. CONTRAINDICATIONS</b> .....	<b>6</b>
<b>4. DOSAGE AND ADMINISTRATION</b> .....	<b>6</b>
4.2 Recommended Dose and Dosage Adjustment.....	6
4.3 Administration.....	8

4.4	Missed Dose .....	10
<b>5.</b>	<b>OVERDOSAGE .....</b>	<b>10</b>
<b>6.</b>	<b>DOSAGE FORMS, STRENGTHS, COMPOSITION AND PACKAGING .....</b>	<b>10</b>
<b>7.</b>	<b>WARNINGS AND PRECAUTIONS .....</b>	<b>12</b>
7.1	Special Populations .....	14
7.1.1	Pregnant Women .....	14
7.1.2	Breast-feeding .....	14
7.1.3	Pediatrics .....	14
7.1.4	Geriatrics .....	15
<b>8.</b>	<b>ADVERSE REACTIONS .....</b>	<b>15</b>
8.2	Clinical Trial Adverse Reactions .....	15
8.5	Post-Market Adverse Reactions .....	24
<b>9.</b>	<b>DRUG INTERACTIONS .....</b>	<b>25</b>
9.4	Drug-Drug Interactions .....	25
9.5	Drug-Food Interactions .....	25
9.6	Drug-Herb Interactions .....	25
9.7	Drug-Laboratory Test Interactions .....	25
<b>10.</b>	<b>CLINICAL PHARMACOLOGY .....</b>	<b>26</b>
10.1	Mechanism of Action .....	26
10.2	Pharmacodynamics .....	26
10.3	Pharmacokinetics .....	27
<b>11.</b>	<b>STORAGE, STABILITY AND DISPOSAL .....</b>	<b>30</b>
<b>12.</b>	<b>SPECIAL HANDLING INSTRUCTIONS .....</b>	<b>30</b>
<b>PART II: SCIENTIFIC INFORMATION .....</b>		<b>32</b>
<b>13.</b>	<b>PHARMACEUTICAL INFORMATION .....</b>	<b>32</b>
<b>14.</b>	<b>CLINICAL TRIALS .....</b>	<b>33</b>
14.1	Trial Design and Study Demographics .....	33
14.2	Study Results .....	45
<b>15.</b>	<b>MICROBIOLOGY .....</b>	<b>65</b>
<b>16.</b>	<b>NON-CLINICAL TOXICOLOGY .....</b>	<b>66</b>
<b>PATIENT MEDICATION INFORMATION .....</b>		<b>67</b>

<b>INSTRUCTIONS FOR USE.....</b>	<b>75</b>
<b>DUPIXENT 300 MG SINGLE-USE PRE-FILLED SYRINGE WITH NEEDLE SHIELD .....</b>	<b>75</b>
<b>INSTRUCTIONS FOR USE.....</b>	<b>85</b>
<b>DUPIXENT 200 MG SINGLE-USE PRE-FILLED SYRINGE WITH NEEDLE SHIELD .....</b>	<b>85</b>
<b>INSTRUCTIONS FOR USE.....</b>	<b>94</b>
<b>DUPIXENT 300 MG SINGLE-USE PRE-FILLED SYRINGE .....</b>	<b>94</b>
<b>INSTRUCTIONS FOR USE.....</b>	<b>105</b>
<b>DUPIXENT 300 MG SINGLE-USE PRE-FILLED PEN.....</b>	<b>105</b>
<b>INSTRUCTIONS FOR USE.....</b>	<b>115</b>
<b>DUPIXENT 200 MG SINGLE-USE PRE-FILLED PEN.....</b>	<b>115</b>

## PART I: HEALTH PROFESSIONAL INFORMATION

### 1. INDICATIONS

#### ***Atopic Dermatitis***

DUPIXENT (dupilumab injection) is indicated for the treatment of patients aged 6 months and older with moderate-to-severe atopic dermatitis whose disease is not adequately controlled with topical prescription therapies or when those therapies are not advisable.

DUPIXENT can be used with or without topical corticosteroids.

#### ***Asthma***

DUPIXENT is indicated as an add-on maintenance treatment in patients aged 6 years and older with severe asthma with a type 2/eosinophilic phenotype or oral corticosteroid-dependent asthma.

**DUPIXENT is not indicated for relief of acute bronchospasm or status asthmaticus (see WARNINGS AND PRECAUTIONS).**

#### ***Chronic Rhinosinusitis with Nasal Polyposis***

DUPIXENT is indicated as an add-on maintenance treatment with intranasal corticosteroids in adult patients with severe chronic rhinosinusitis with nasal polyposis (CRSwNP) inadequately controlled by systemic corticosteroids and/or surgery.

#### ***Eosinophilic Esophagitis***

DUPIXENT is indicated for the treatment of patients aged 12 years and older, weighing at least 40 kg, with eosinophilic esophagitis (EoE).

#### ***Prurigo Nodularis***

DUPIXENT is indicated for the treatment of adult patients with moderate-to-severe prurigo nodularis (PN) whose disease is not adequately controlled with topical prescription therapies or when those therapies are not advisable. DUPIXENT can be used with or without topical corticosteroids.

### 1.1 Pediatrics

#### ***Atopic Dermatitis***

Efficacy and safety of DUPIXENT in pediatric patients with atopic dermatitis below the age of 6 months have not been established.

#### ***Asthma***

Efficacy and safety in pediatric patients with asthma below the age of 6 years have not been established.

#### ***Chronic Rhinosinusitis with Nasal Polyposis***

Efficacy and safety of DUPIXENT in pediatric patients with CRSwNP have not been established.

#### ***Eosinophilic Esophagitis***

Efficacy and safety of DUPIXENT in pediatric patients with EoE below the age of 12 years have not been established.

### ***Prurigo Nodularis***

Efficacy and safety of DUPIXENT in pediatric patients with PN younger than 18 years have not been established.

## **1.2 Geriatrics**

### ***Atopic Dermatitis***

Of the 1472 patients with atopic dermatitis exposed to DUPIXENT in a phase 2 dose-ranging study or phase 3 placebo-controlled studies, a total of 67 were 65 years or older. Although no differences in efficacy or safety were observed between older and younger patients, the number of patients aged 65 and over is not sufficient to determine whether they respond differently from younger patients (see CLINICAL PHARMACOLOGY, Special Populations and Conditions). No dose adjustment is recommended for elderly patients.

### ***Asthma***

Of the 1977 patients with asthma exposed to DUPIXENT, a total of 240 patients were 65 years or older and 39 patients were 75 years or older. Efficacy and safety in this age group was consistent with the overall study population.

### ***Chronic Rhinosinusitis with Nasal Polyposis***

Of the 440 patients with CRSwNP exposed to DUPIXENT, a total of 79 were 65 years and older. Efficacy and safety in this age group were consistent with the overall study population. A total of 11 patients were 75 years and older (see CLINICAL PHARMACOLOGY, Special Populations and Conditions). No dose adjustment is recommended for elderly patients.

### ***Eosinophilic Esophagitis***

Of 203 subjects with EoE exposed to DUPIXENT in the phase 3 study, a total of 2 were 65 years of age or older.

### ***Prurigo Nodularis***

Of 152 patients with PN exposed to DUPIXENT, a total of 37 patients were 65 years of age or older and 8 patients were 75 years or older.

## **2. CONTRAINDICATIONS**

Dupixent is contraindicated in patients who are hypersensitive to this drug or to any ingredient in the formulation or component of the container. For a complete listing, see the DOSAGE FORMS, STRENGTHS, COMPOSITION AND PACKAGING section of the product monograph.

## **4. DOSAGE AND ADMINISTRATION**

### **4.2 Recommended Dose and Dosage Adjustment**

Dupixent is administered by subcutaneous injection.

Provide proper training to patients and/or caregivers on proper subcutaneous injection technique, including aseptic technique, and the preparation and administration of Dupixent prior to use. Advise patients to follow sharps disposal recommendations (see Instructions for Use).

## ***Atopic Dermatitis***

### Adults

The recommended dose of Dupixent for adult patients with atopic dermatitis is an initial dose of 600 mg (two 300 mg injections), followed by 300 mg every other week.

### Pediatrics (6 to 17 years of age)

The recommended dose of Dupixent for pediatrics 6 to 17 years of age is specified in **Table 1**.

**Table 1 – Dose of Dupixent for Subcutaneous Administration in Pediatrics 6 to 17 Years of Age with Atopic Dermatitis**

<b>Body Weight</b>	<b>Initial Dose</b>	<b>Subsequent Doses</b>
15 to less than 30 kg	600 mg (two 300 mg injections)	300 mg every 4 weeks <b>(Q4W)</b>
30 to less than 60 kg	400 mg (two 200 mg injections)	200 mg every other week <b>(Q2W)</b>
60 kg or more	600 mg (two 300 mg injections)	300 mg every other week <b>(Q2W)</b>

### Pediatrics (6 months to 5 years of age)

The recommended dose of Dupixent for pediatrics 6 months to 5 years of age is specified in **Table 2**.

**Table 2: Dose of Dupixent for Subcutaneous Administration in Pediatrics 6 months to 5 Years of Age with Atopic Dermatitis**

<b>Body Weight</b>	<b>Initial Dose</b>	<b>Subsequent Doses</b>
5 to less than 15 kg	200 mg (one 200 mg injection)	200 mg every 4 weeks <b>(Q4W)</b>
15 to less than 30 kg	300 mg (one 300 mg injection)	300 mg every 4 weeks <b>(Q4W)</b>

Dupixent can be used with or without topical corticosteroids. Topical calcineurin inhibitors may be used, but should be reserved for problem areas only, such as the face, neck, intertriginous and genital areas.

## ***Asthma***

### Adults and adolescents (12 years of age and older)

The recommended dose of Dupixent for adults and adolescents (12 years of age and older) is:

- An initial dose of 400 mg (two 200 mg injections) followed by 200 mg given every other week for patients with severe asthma with a type 2/eosinophilic phenotype. The dose may be increased to 300 mg every-other-week based on clinical judgement.
- An initial dose of 600 mg (two 300 mg injections) followed by 300 mg given every-other-week for patients with oral corticosteroids-dependent asthma or with co-morbid moderate-to-severe atopic dermatitis or adults with co-morbid severe chronic rhinosinusitis with nasal polyposis for which Dupixent is indicated.

### Pediatrics (6 to 11 years of age)

The recommended dose of Dupixent for children aged 6 to 11 years is specified in **Table 3**.

**Table 3– Dose of Dupixent for Subcutaneous Administration Pediatrics 6 to 11 Years of Age with Asthma**

<b>Body Weight</b>	<b>Initial and Subsequent Doses*</b>
15 to less than 30 kg	300 mg every four weeks ( <b>Q4W</b> )†
30 to less than 60 kg	200 mg every other week ( <b>Q2W</b> ) or 300 mg every four weeks ( <b>Q4W</b> )†
60 kg or more	200 mg every other week ( <b>Q2W</b> )

\*For pediatrics (6 to 11 years) with asthma, no initial loading dose is recommended.

†Based on population PK modeling (see 10 CLINICAL PHARMACOLOGY).

For pediatrics (6-11 years old) with asthma and co-morbid moderate-to-severe atopic dermatitis, the recommended dose specified in **Table 1** should be followed.

***Chronic Rhinosinusitis with Nasal Polyps***

The recommended dose of Dupixent for adult patients with chronic rhinosinusitis with nasal polyps is 300 mg every-other-week.

***Eosinophilic Esophagitis***

The recommended dose of Dupixent for patients 12 years of age and older, weighing at least 40 kg, is 300 mg given every week (QW).

***Prurigo Nodularis***

The recommended dose of Dupixent for adult patients is an initial dose of 600 mg (two 300 mg injections), followed by 300 mg given every other week.

**4.3 Administration**

For atopic dermatitis, asthma and prurigo nodularis patients receiving an initial 600 mg dose, administer two 300 mg Dupixent injections consecutively in different injection sites.

For atopic dermatitis and asthma patients taking the initial 400 mg dose, administer two 200 mg Dupixent injections consecutively in different injection sites.

Dupixent is intended for use under the guidance of a healthcare professional. A patient may self-inject Dupixent or the patient's caregiver may administer Dupixent. In children 6 months to less than 12 years of age, Dupixent should be given by a caregiver. In adolescents 12 years of age and older, it is recommended that Dupixent be given by or under the supervision of an adult.

The Dupixent pre-filled pen is only for use in adults and pediatric patients aged 2 years and older. The Dupixent pre-filled syringe can be used in adults and pediatric patients aged 6 months and older. It should be given by a caregiver in pediatric patients 6 months to 11 years of age with atopic dermatitis. Provide proper training to patients and/or caregivers on the preparation and administration of Dupixent prior to use according to the Instructions for Use (IFU).

Dupixent is self-administered by subcutaneous injection into the thigh or abdomen, except for the 5 cm (2 inches) around the navel, using a single-use pre-filled syringe or pen. If a caregiver administers



Dupixent, an injection in the upper arm can also be used.

It is recommended to rotate the injection site with each injection.

Dupixent should not be injected into skin that is tender, damaged or has bruises or scars.

In the absence of compatibility studies, this medicinal product must not be mixed with other medicinal products.

### **Special populations**

#### ***Pediatrics (< 18 years of age):***

##### Atopic Dermatitis

Efficacy and safety of Dupixent in pediatric patients with atopic dermatitis below the age of 6 months have not been established.

##### Asthma

Efficacy and safety of Dupixent in pediatric patients with asthma below the age of 6 years have not been established.

##### Chronic Rhinosinusitis with Nasal Polyps

Efficacy and safety of Dupixent in pediatric patients with CRSwNP have not been established.

##### Eosinophilic Esophagitis

Efficacy and safety of Dupixent in pediatric patients with EoE younger than 12 years of age have not been established.

##### Prurigo Nodularis

Efficacy and safety of Dupixent in pediatric patients with PN younger than 18 years have not been established.

#### ***Geriatrics (>65 years of age):***

No dose adjustment is recommended for elderly patients (see CLINICAL PHARMACOLOGY, Special Populations and Conditions).

#### ***Hepatic impairment***

No data are available in patients with hepatic impairment (see CLINICAL PHARMACOLOGY, Special Populations and Conditions).

#### ***Renal impairment***

No dosage adjustment is recommended in patients with mild or moderate renal impairment. No data are available in patients with severe renal impairment (see CLINICAL PHARMACOLOGY, Special Populations and Conditions).

#### ***Body weight***

No dose adjustment for body weight is recommended in adults with atopic dermatitis, CRSwNP or PN and for adults and adolescents with asthma (see CLINICAL PHARMACOLOGY, Special Populations and Conditions).

For pediatric patients 6 to 17 years of age with atopic dermatitis, the recommended dose is 300 mg Q4W (15 kg to <30 kg), 200 mg Q2W (30 kg to <60 kg), or 300 mg Q2W (≥60 kg) following an initial dose

of 600 mg, 400 mg, or 600 mg, respectively. (see DOSAGE AND ADMINISTRATION, Recommended Dose and Dosage Adjustment).

For pediatric patients 6 to 11 years of age with asthma, the recommended doses are 300 mg Q4W ( $\geq 15$  kg to  $< 30$  kg), 200 mg Q2W or 300 mg Q4W ( $\geq 30$  kg to  $< 60$  kg), and 200 mg Q2W ( $\geq 60$  kg) (see DOSAGE AND ADMINISTRATION, Recommended Dose and Dosage Adjustment).

For pediatric patients 6 months to 5 years of age with atopic dermatitis, the recommended dose is 200 mg Q4W (5 kg to  $< 15$  kg) and 300 mg Q4W (15 kg to  $< 30$  kg). (see DOSAGE AND ADMINISTRATION, Recommended Dose and Dosage Adjustment).

#### 4.4 Missed Dose

If a weekly dose is missed, administer the dose as soon as possible, and start a new weekly schedule from the date of this administered dose.

If an every other week dose is missed, instruct the patient to administer the injection within 7 days from the missed dose and then resume the patient's original schedule. If the missed dose is not administered within 7 days, instruct the patient to wait until the next dose on the original schedule.

If an every 4 week dose is missed, instruct the patient to administer the injection within 7 days from the missed dose and then resume the patient's original schedule. If the missed dose is not administered within 7 days, instruct the patient to administer the dose, starting a new schedule based on this date.

## 5. OVERDOSAGE

In clinical studies, no safety issues were identified with single intravenous doses up to 12 mg/kg.

There is no specific treatment for Dupixent overdose. In the event of overdose, monitor the patient for any signs or symptoms of adverse reactions and institute appropriate symptomatic treatment immediately.

For management of a suspected drug overdose, contact your regional poison control centre.

## 6. DOSAGE FORMS, STRENGTHS, COMPOSITION AND PACKAGING

To help ensure the traceability of biologic products, including biosimilars, health professionals should recognise the importance of recording both the brand name and the non-proprietary (active ingredient) name as well as other product-specific identifiers such as the Drug Identification Number (DIN) and the batch/lot number of the product supplied.

**Table 4 – Dosage Forms, Strengths, Composition and Packaging**

Route of Administration	Dosage Form / Strength/Composition	Non-medicinal Ingredients
Subcutaneous injection	Solution: - 150 mg/mL (300 mg/2 mL): pre-filled syringe with needle shield (PFS-S), pre-filled syringe	L-arginine hydrochloride, L-histidine, polysorbate 80, sodium acetate, sucrose, acetic acid for pH adjustment, water for injection.

	(PFS) or pre-filled pen (PFP) - 175 mg/mL (200 mg/1.14 mL): pre-filled syringe with needle shield (PFS-S) or pre-filled pen (PFP) -	
--	---	--

Dupixent is supplied as a clear to slightly opalescent, colorless to pale yellow sterile, preservative-free, solution, which is free from visible particulates.

Dupixent 300 mg is available in a single-use pre-filled syringe with needle shield (PFS-S), a single-use pre-filled syringe (PFS) or pre-filled pen (PFP), designed to deliver 300 mg dupilumab in 2 mL solution (150 mg/mL) via subcutaneous injection.

Dupixent 200 mg is available in a single-use pre-filled syringe with needle shield (PFS-S) or pre-filled pen (PFP), designed to deliver 200 mg dupilumab in 1.14 mL solution (175 mg/mL) via subcutaneous injection.

.

#### 300 mg Pre-Filled Syringe with needle shield

- Dupixent is provided as a single dose in a 2.25-mL siliconized clear Type-1 glass pre-filled syringe with a fixed 27-gauge ½ inch, thin wall stainless steel staked needle and passive needle shield.
- The needle cap is not made with natural rubber latex.

#### 300 mg Pre-filled Syringe

- Dupixent is provided as a single dose in a 2.25-mL siliconized clear Type-1 glass pre-filled syringe with a fixed 27 gauge ½ inch, thin wall stainless steel staked needle.
- The needle cap is not made with natural rubber latex.

#### 300 mg Pre-filled Pen

- Dupixent is provided as a single dose in a 2.25-mL siliconized clear Type-1 glass syringe.
- The needle cap is not made with natural rubber latex.

#### 200 mg Pre-Filled Syringe with needle shield

- Dupixent is provided as a single dose in a 1.14-mL siliconized clear Type-1 glass pre-filled syringe with a fixed 27 gauge ½ inch, thin wall stainless steel staked needle and passive needle shield.
- The needle cap is not made with natural rubber latex.

#### 200 mg Pre-filled Pen

- Dupixent is provided as a single dose in a 1.14-mL siliconized clear Type-1 glass syringe.
- The needle cap is not made with natural rubber latex.

The pre-filled pen is available either with a round cap and oval viewing window encircled with an arrow

or with a square cap with ridges and an oval viewing window without an arrow.

Dupixent is available in packs containing 1 or 2 pre-filled syringes with needle shield or pre-filled syringes or pre-filled pens

## **7. WARNINGS AND PRECAUTIONS**

### **General**

#### ***Acute Asthma Symptoms or Deteriorating Disease***

Dupixent (dupilumab injection) should not be used to treat acute asthma symptoms or acute exacerbations. Do not use Dupixent to treat acute bronchospasm or status asthmaticus.

Patients should be instructed to seek medical advice if their asthma remains uncontrolled or worsens after initiation of treatment with Dupixent.

#### ***Reduction of Corticosteroid Dosage***

Do not discontinue systemic, topical, or inhaled corticosteroids abruptly upon initiation of treatment with Dupixent. Reductions in corticosteroid dose, if appropriate, should be gradual and only performed under the supervision of a healthcare professional. Reduction in corticosteroid dose may be associated with systemic withdrawal symptoms and/or may unmask conditions previously suppressed by systemic corticosteroid therapy.

Patients with atopic dermatitis or CRSwNP who have comorbid asthma should be advised not to adjust or stop their asthma treatments without consulting their healthcare professional.

### **Immune**

#### ***Hypersensitivity***

Hypersensitivity reactions, including anaphylaxis, serum sickness or serum sickness-like reactions and angioedema, some of which have been serious, have been reported following the use of Dupixent. If a systemic hypersensitivity reaction occurs, including generalized urticaria, rash, erythema nodosum, serum sickness or serum-sickness-like reactions (occurred in less than 1% of subjects who received Dupixent in clinical trials), administration of Dupixent should be discontinued immediately and appropriate therapy initiated. One case of anaphylaxis has been reported in the asthma development program following the administration of Dupixent (see ADVERSE REACTIONS). Advise patients to discontinue Dupixent and to seek immediate medical attention if they experience any symptoms of systemic hypersensitivity reactions.

#### ***Eosinophilic Conditions***

Dupixent has been associated with an elevation of blood eosinophils. Patients being treated for asthma may present with serious systemic eosinophilia sometimes presenting with clinical features of eosinophilic pneumonia or vasculitis consistent with eosinophilic granulomatosis with polyangiitis, conditions that are often treated with systemic corticosteroids. These events usually, but not always, may be associated with the reduction of oral corticosteroid therapy.

Cases of eosinophilic pneumonia were reported with Dupixent in adult subjects who participated in the asthma development program and cases of vasculitis consistent with eosinophilic granulomatosis with

polyangiitis have been reported in subjects who participated in the asthma development program as well as in adult subjects with co-morbid asthma receiving Dupixent in the CRSwNP development program. Healthcare professionals should be alert to vasculitic rash, worsening pulmonary symptoms, cardiac complications, and/or neuropathy presenting in patients with eosinophilia. A causal association between Dupixent and these conditions has not been established.

### ***Helminth Infection***

Patients with known helminth infections were excluded from participation in clinical studies. It is unknown if Dupixent will influence the immune response against helminth infections. Treat patients with pre-existing helminth infections before initiating Dupixent. If patients become infected while receiving treatment with Dupixent and do not respond to anti-helminth treatment, discontinue treatment with Dupixent until infection resolves. Adverse reactions of helminth infections (5 cases of enterobiasis and 1 case of ascariasis) were reported in children 6 to 11 years old who participated in the pediatric asthma development program (see ADVERSE REACTIONS).

### ***Conjunctivitis and Keratitis***

Conjunctivitis and keratitis related events occurred more frequently in subjects with atopic dermatitis who received Dupixent than in subjects who received placebo, and more frequently in subjects with atopic dermatitis than in other indications. Some patients reported visual disturbances (e.g. blurred vision) associated with conjunctivitis or keratitis (see ADVERSE REACTIONS).

Among asthma subjects, the frequency of conjunctivitis was low and consistent between Dupixent and placebo.

In subjects with CRSwNP or PN, the frequency of conjunctivitis was higher in dupilumab compared to placebo. There were no cases of keratitis reported in the CRSwNP and PN development program (see ADVERSE REACTIONS).

Conjunctivitis and keratitis related events (including ulcerative keratitis) have been reported in the postmarketing setting.

Advise patients to report new onset or worsening eye symptoms to their healthcare professional. Patients treated with Dupixent who develop conjunctivitis that does not resolve following standard treatment or signs and symptoms suggestive of keratitis should undergo ophthalmological examination, as appropriate (see ADVERSE REACTIONS).

### ***Concomitant Atopic Conditions***

Patients with atopic dermatitis and comorbid asthma should be advised not to adjust their treatment without consultation with their healthcare professional. If discontinuing Dupixent, consider the potential effects on other atopic conditions.

## **Musculoskeletal and connective tissue disorders**

### ***Arthralgia***

Arthralgia has been reported with the use of Dupixent with some patients reporting gait disturbances or decreased mobility associated with joint symptoms; some cases resulted in hospitalization. In clinical trials and postmarketing reports, onset of arthralgia was variable, ranging from days to months after the first dose of Dupixent. Some patients' symptoms resolved while continuing treatment with Dupixent and other patients recovered or were recovering following discontinuation of Dupixent (see ADVERSE REACTIONS).

Advise patients to report new onset or worsening joint symptoms to their healthcare provider. If symptoms persist or worsen, consider rheumatological evaluation and/or discontinuation of Dupixent.

## **Reproductive Health: Female and Male Potential**

### ***Fertility***

No specific non-clinical animal study on fertility has been conducted with dupilumab (see NON-CLINICAL TOXICOLOGY).

## **7.1 Special Populations**

### **7.1.1 Pregnant Women**

No studies have been conducted with Dupixent in pregnant women and relevant data from clinical use are very limited. Human IgG antibodies are known to cross the placental barrier; therefore, Dupixent may be transmitted from the mother to the developing fetus. Non-clinical animal reproductive and developmental toxicology studies were not conducted with dupilumab due to lack of pharmacologic activity in non-human species (see NON-CLINICAL TOXICOLOGY).

### **7.1.2 Breast-feeding**

There is no information regarding the presence of Dupixent in human breast milk, the effects on the breastfed infant, or the effects on milk production. The developmental and health benefits of breastfeeding should be considered along with the mother's clinical need for Dupixent and any potential adverse effects on the breastfed child from Dupixent or from the underlying maternal condition.

### **7.1.3 Pediatrics**

#### ***Atopic Dermatitis***

Efficacy and safety of Dupixent in pediatric patients with atopic dermatitis less than 6 months of age have not been established.

#### ***Asthma***

Efficacy and safety in pediatric patients with asthma below the age of 6 years have not been established.

For 107 adolescents aged 12 to 17 years with asthma (68 exposed to dupilumab), the safety profile was consistent with the overall adult population.

For 405 children aged 6 to 11 with asthma (271 exposed to dupilumab), the safety profile was consistent with the overall adult and adolescent populations with the additional adverse reaction of helminth infection.

#### ***Chronic Rhinosinusitis with Nasal Polyposis***

Efficacy and safety in pediatric subjects (<18 years of age) with CRSwNP have not been established.

#### ***Eosinophilic Esophagitis***

Efficacy and safety in pediatric patients with EoE younger than 12 years of age have not been established.

For 99 adolescents aged 12 to 17 years with EoE (64 exposed to dupilumab), the safety profile was consistent with the overall adult population.

#### ***Prurigo Nodularis***

Efficacy and safety in pediatric subjects (<18 years of age) with PN have not been established.

### **7.1.4 Geriatrics**

#### ***Atopic Dermatitis***

Of the 1472 patients with atopic dermatitis exposed to Dupixent in a phase 2 dose-ranging study or phase 3 placebo-controlled studies, a total of 67 were 65 years or older. Although no differences in efficacy or safety were observed between older and younger subjects, the number of subjects aged 65 and over is not sufficient to determine whether they respond differently from younger subjects.

#### ***Asthma***

Of the 1977 patients with asthma exposed to Dupixent, a total of 240 patients were 65 years or older and 39 patients were 75 years or older. Efficacy and safety in this age group was consistent with the overall study population.

#### ***Chronic Rhinosinusitis with Nasal Polyposis***

Of the 440 subjects with CRSwNP exposed to Dupixent, a total of 79 were 65 years and older. Efficacy and safety in this age group were consistent with the overall study population. A total of 11 subjects were 75 years and older. No dose adjustment is recommended for elderly patients.

#### ***Eosinophilic Esophagitis***

Clinical studies of Dupixent in EoE did not include sufficient numbers of subjects aged 65 years and over to determine whether they respond differently than younger adult subjects.

#### ***Prurigo Nodularis***

Of 152 patients with PN exposed to Dupixent, a total of 37 patients were 65 years of age or older and 8 patients were 75 years or older. The number of subjects aged 65 and over is not sufficient to determine whether they respond differently from younger subjects.

## **8. ADVERSE REACTIONS**

### **8.2 Clinical Trial Adverse Reactions**

*Clinical trials are conducted under very specific conditions. The adverse reaction rates observed in the clinical trials; therefore, may not reflect the rates observed in practice and should not be compared to the rates in the clinical trials of another drug. Adverse reaction information from clinical trials may be useful in identifying and approximating rates of adverse drug reactions in real-world use.*

#### **Atopic Dermatitis**

##### **Adults**

In the overall exposure pool, a total of 2526 subjects with atopic dermatitis were treated with Dupixent in controlled and uncontrolled clinical trials. Of these, 739 subjects were exposed for at least 1 year.

The safety of Dupixent monotherapy was evaluated through week 16 based on data from three randomized, double-blind, placebo-controlled multicenter studies (SOLO 1, SOLO 2, and a phase 2, dose-ranging study) that included 1564 adult subjects with moderate-to-severe atopic dermatitis (AD). The study population had a mean age of 38.2 years, 41.1 % was female, 67.9 % white, 21.9 % Asian, 7.1% black, and reported co-morbid atopic conditions such as asthma (39.6%), allergic rhinitis (49.0%), food allergy (37.3%), and allergic conjunctivitis (23.1%).

The safety of Dupixent with concomitant topical corticosteroids (TCS) was evaluated based on data from one randomized, double-blind, placebo-controlled multicentre study (CHRONOS). A total of 740 subjects were treated up to 52 weeks. The study population had a mean age of 37.1 years, 39.7% was female, 66.2% white, 27.2% Asian, 4.6% black, and reported co-morbid atopic conditions such as asthma (39.3%), allergic rhinitis (42.8%), food allergy (33.4%), and allergic conjunctivitis (23.2%).

In the monotherapy studies, the proportion of subjects who discontinued treatment due to adverse events was 1.9% of the placebo group and 1.9% of the Dupixent 300 mg every other week (Q2W) group.

In the concomitant TCS study, the proportion of subjects who discontinued treatment due to adverse events was 7.6% of the placebo + TCS group and 1.8% of the Dupixent 300 mg Q2W + TCS group.

In a phase 3, multicentre, open label extension (OLE) study (AD-1225), the long-term safety of repeat doses of Dupixent was assessed in adults with moderate-to-severe AD who had previously participated in controlled studies of Dupixent or had been screened for a phase 3 study (SOLO1 or SOLO2). The safety data in AD-1225 reflect the exposure to Dupixent in 2677 adult atopic dermatitis patients, including 2254 who completed at least 52 weeks, 1192 who completed at least 100 weeks and 357 who completed at least 148 weeks of the study. The majority of the patients in Trial AD-1225 (99.7%) were exposed to Dupixent 300 mg weekly dosing (QW). The long-term safety profile observed in this study up to 148 weeks was generally consistent with the safety profile of Dupixent observed in controlled studies.

**Table 5** summarizes the adverse reactions that occurred in  $\geq 1\%$  of subjects treated with Dupixent during the first 16-weeks of treatment in placebo-controlled trials.



**Table 5 – Adverse Reactions Occurring in ≥1% of subjects with Atopic Dermatitis Treated with Dupixent through Week 16 in Placebo-Controlled Trials**

Adverse Reaction	Dupixent Monotherapy <sup>a</sup>		Dupixent + TCS <sup>b</sup>	
	Placebo N=517 n (%)	Dupixent 300 mg Q2W N=529 n (%)	Placebo +TCS N=315 n (%)	Dupixent 300 mg Q2W + TCS N=110 n (%)
Injection site reaction	28 (5.4%)	51 (9.6%)	18 (5.7%)	11 (10.0%)
Conjunctivitis <sup>c</sup>	12(2.3%)	51(9.6%)	15 (4.8%)	10(9.1%)
Blepharitis	1 (0.2%)	2 (0.4%)	2 (0.6%)	5 (4.5%)
Oral herpes	8 (1.5%)	20 (3.8%)	5 (1.6%)	3 (2.7%)
Eye pruritus	1 (0.2%)	3 (0.6%)	2 (0.6%)	2 (1.8%)
Dry eye	0	1 (0.2%)	1 (0.3%)	2 (1.8%)
Herpes simplex <sup>d</sup>	4 (0.8%)	9 (1.7%)	1 (0.3%)	1 (0.9%)
Keratitis <sup>e</sup>	0	1 (0.2%)	0	4(3.6%)
Eosinophilia	2 (0.4%)	9 (1.7%)	0	1 (0.9%)

<sup>a</sup> Safety data from a phase 2, dose-ranging study and the SOLO 1 and SOLO 2 studies.

<sup>b</sup> Safety data from the CHRONOS study. Subjects were on background TCS therapy.

<sup>c</sup> Conjunctivitis cluster includes conjunctivitis, allergic conjunctivitis, bacterial conjunctivitis, viral conjunctivitis, giant papillary conjunctivitis, eye irritation, and eye inflammation.

<sup>d</sup> In clinical trials, herpes simplex cases were mucocutaneous, generally mild to moderate in severity, and did not include eczema herpeticum. Eczema herpeticum cases were reported separately and incidence was lower in subjects treated with Dupixent compared to placebo.

<sup>e</sup> Keratitis cluster includes keratitis, ulcerative keratitis, allergic keratitis, atopic keratoconjunctivitis, and ophthalmic herpes simplex.

Q2W: every other week; TCS: topical corticosteroids

The safety profile of Dupixent + TCS through week 52 was consistent with the safety profile observed at week 16.

#### Adolescents

The safety of Dupixent was assessed in a study of 250 subjects 12 to 17 years of age with moderate-to-severe atopic dermatitis (AD-1526). The safety profile of Dupixent in these subjects followed through Week 16 was consistent with the safety profile from studies in adults with atopic dermatitis.

The longer term safety of Dupixent was assessed in a 52-week open-label extension study in subjects 12 to 17 years of age with moderate-to-severe atopic dermatitis (AD-1434). The safety profile of Dupixent in subjects followed through Week 52 was consistent to the safety profile observed at Week 16 in AD-1526 study. Overall, the safety profile of Dupixent observed in adolescents was consistent with that seen in adults with atopic dermatitis.

#### Pediatrics (6 to 11 years of age)

The safety of Dupixent was assessed in a trial of 367 pediatric subjects 6 to 11 years of age with severe

atopic dermatitis (AD-1652). The safety profile of Dupixent + TCS in these subjects through Week 16 was consistent with the safety profile established in adults and adolescents with atopic dermatitis.

The longer term safety of Dupixent + TCS was assessed in a 52-week open-label extension study including 368 subjects 6 to 11 years of age with atopic dermatitis (AD-1434) who had participated in a prior atopic dermatitis study of Dupixent. Among subjects who entered this study, 110 (29.9%) had moderate, and 72 (19.6%) had severe atopic dermatitis at the time of enrolment. The safety profile of Dupixent + TCS in subjects followed through Week 52 from trial AD-1434 was consistent with that observed at Week 16 from trial AD-1652. Overall, the safety profile of Dupixent + TCS observed in children was consistent with that seen in adults and adolescents with atopic dermatitis.

#### Pediatrics (6 months to 5 years of age)

The safety of Dupixent + TCS was assessed in a study of 161 pediatric patients 6 months to 5 years of age with moderate-to-severe atopic dermatitis (AD-1539). The safety profile of Dupixent + TCS in these patients through Week 16 was consistent with the safety profile from studies in adults and pediatric patients 6 to 17 years of age with atopic dermatitis.

The long-term safety of Dupixent + TCS was assessed in an open-label extension study of 180 patients 6 months to 5 years of age with atopic dermatitis (AD-1434). The majority of subjects were treated with Dupixent 300 mg every 4 weeks. The safety profile of Dupixent + TCS in subjects followed through Week 52 was similar to the safety profile observed through Week 16 in AD-1539. The long-term safety profile of Dupixent + TCS observed in pediatric subjects 6 months to 5 years of age was consistent with that seen in adults and pediatric patients 6 to 17 years old with atopic dermatitis.

### **Asthma**

#### Adults and adolescents

A total of 2888 adult and adolescent subjects with moderate-to-severe asthma were evaluated in 3 randomized, placebo-controlled, multicentre trials of 24 to 52 weeks duration (DRI12544, QUEST, and VENTURE). Of these, 2678 subjects had a history of 1 or more severe exacerbations in the year prior to enrollment despite regular use of medium- to high-dose inhaled corticosteroids plus an additional controller(s) (DRI12544 and QUEST), while 210 subjects were receiving high-dose inhaled corticosteroids plus up to two additional controllers along with maintenance oral corticosteroids (VENTURE). The safety population (DRI12544 and QUEST) had a mean age of 48.1 years, 63.4% were female, 81.9% were white, 12.5% Asian, 4.4% black, and 76.9% reported co-morbid atopic conditions such as, allergic rhinitis (67.5%), allergic conjunctivitis (14.5%), chronic rhinosinusitis (17.3%), nasal polyposis (12.3%), atopic dermatitis (9.7%), and food allergy (8.5%). Dupixent 200 mg or 300 mg was administered subcutaneously every-other-week, following an initial dose of 400 mg or 600 mg, respectively.

In DRI12544 and QUEST studies, the proportion of subjects who discontinued treatment due to an adverse event was 3.2% in the Dupixent 200 mg Q2W group, 6.1% in the Dupixent 300 mg Q2W group, and 4.3% in the combined placebo group.

**Table 6** summarizes the adverse reactions that occurred at a rate of at least 1% in subjects receiving Dupixent and at higher rate than in their respective comparator groups in DRI12544 and QUEST studies.

**Table 6 – Adverse Reactions Occurring in ≥1% of the Dupixent Groups in DRI12544 and QUEST and Greater than Placebo (6 Month Safety Pool)**

Adverse Reaction	DRI12544 and QUEST		
	Dupixent 200 mg Q2W  N=779 n (%)	Dupixent 300 mg Q2W  N=788 n (%)	Placebo  N=792 n (%)
Injection site reactions <sup>a</sup>	111 (14%)	144 (18%)	50 (6%)
Oropharyngeal pain	13 (2%)	19 (2%)	7 (1%)
Eosinophilia <sup>b</sup>	17 (2%)	16 (2%)	2 (<1%)

<sup>a</sup> Injection site reactions cluster includes erythema, edema, pruritus, pain, and inflammation.

<sup>b</sup> Eosinophilia = blood eosinophils ≥3,000 cells/mcL, or deemed by the investigator to be an adverse event. None met the criteria for serious eosinophilic conditions (*see* WARNINGS AND PRECAUTIONS).

The long-term safety of Dupixent was assessed in an open-label extension study in 2193 adults and 89 adolescents (aged 12 to 17 years) with moderate-to-severe asthma, including 185 adults with oral corticosteroid-dependent asthma (TRAVERSE). In this study, patients were followed for up to 96 weeks, resulting in 3169 patient-years cumulative exposure to Dupixent. The safety profile of Dupixent in TRAVERSE was consistent with the safety profile observed in pivotal asthma studies for up to 52 weeks of treatment.

#### Pediatrics (6 to 11 years of age)

The safety of Dupixent was assessed in 405 patients 6 to 11 years of age with moderate-to-severe asthma (VOYAGE). The safety profile of Dupixent in these patients through Week 52 was similar to the safety profile from studies in adults and adolescents with moderate-to-severe asthma (Table 5), with the additional adverse reaction of helminth infections. Helminth infections were reported in 2.2% (6 subjects) in the Dupixent groups and 0.7% (1 subjects) in the placebo group. The majority of cases were enterobiasis, reported in 1.8% (5 patients) in the Dupixent groups and none in the placebo group. There was one case of ascariasis in the Dupixent groups. All helminth infections cases were mild to moderate and patients recovered with anti-helminth treatment without Dupixent treatment discontinuation.

#### Chronic Rhinosinusitis with Nasal Polyposis

A total of 722 adult subjects with chronic rhinosinusitis with nasal polyposis (CRSwNP) were evaluated in 2 randomized, placebo-controlled, multicentre trials of 24 to 52 weeks duration (SINUS-24 and SINUS-52) The safety pool consisted of data from the first 24 weeks of treatment.

In the safety pool, the proportion of subjects who discontinued treatment due to adverse events was 2.0% of the Dupixent 300 mg Q2W group and 4.6% of the placebo group. **Table 7** summarizes the adverse reactions that occurred at a rate of at least 1% in subjects treated with Dupixent and at a higher rate than in their respective comparator group in SINUS-24 and SINUS-52.

**Table 7 – Adverse Reactions Occurring in  $\geq 1\%$  of the Dupixent Group in SINUS-24 and SINUS-52 and at a greater frequency than Placebo (24-Week Safety Pool)**

Adverse Reaction	SINUS-24 and SINUS-52	
	Dupixent 300 mg Q2W N=440 n (%)	Placebo N=282 n (%)
Injection site reactions <sup>a</sup>	28 (6.4%)	12 (4.3%)
Conjunctivitis <sup>b</sup>	7 (1.6%)	2 (0.7%)
Arthralgia	14 (3.2%)	5 (1.8%)
Gastritis	7 (1.6%)	2 (0.7%)
Insomnia	6 (1.4%)	0 (0%)
Eosinophilia	5 (1.1%)	1 (0.4%)

<sup>a</sup> Injection site reactions cluster includes injection site reactions, pain, bruising, and swelling.

<sup>b</sup> Conjunctivitis cluster includes conjunctivitis, allergic conjunctivitis, bacterial conjunctivitis, viral conjunctivitis, giant papillary conjunctivitis, eye irritation, and eye inflammation.

The safety profile of Dupixent through Week 52 was generally consistent with the safety profile observed at Week 24.

### **Prurigo Nodularis**

A total of 309 adult patients with prurigo nodularis (PN) were evaluated in two 24-week randomized, double-blind, placebo-controlled, multicenter trials (PRIME and PRIME2). The safety pool included data from the 24 week treatment and available 12 week follow-up periods from both studies.

In the safety pool, the proportion of patients who discontinued treatment due to adverse events was 3% of the placebo group and 0% of the DUPIXENT 300 mg Q2W group.

Table 8 summarizes the adverse reactions that occurred at a rate of at least 2% in patients treated with DUPIXENT and at a higher rate than in their respective comparator group in PRIME and PRIME2.

**Table 8- Adverse Reactions Occurring with a frequency  $\geq 2\%$  in dupilumab group in PRIME and PRIME2 Pooled safety population and difference  $\geq 1\%$  versus placebo group.**

Adverse Reaction	PRIME and PRIME2	
	DUPIXENT 300 mg Q2W N=152 n (%)	Placebo N=157 n (%)
Nasopharyngitis <sup>a</sup>	8 (5%)	3 (2%)
Conjunctivitis <sup>b</sup>	6 (4%)	2 (1%)
Herpes infections <sup>c</sup>	5 (3%)	0 (0%)
Dizziness <sup>d</sup>	5 (3%)	2 (1%)
Myalgia <sup>e</sup>	5 (3%)	2 (1%)
Diarrhea	4 (3%)	1 (1%)

- a Nasopharyngitis includes pharyngitis
- b Conjunctivitis cluster includes conjunctivitis, allergic conjunctivitis, bacterial conjunctivitis, viral conjunctivitis, giant papillary conjunctivitis, eye irritation, and eye inflammation. In the PN program, the observed events from the cluster in the DUPIXENT arm were conjunctivitis and allergic conjunctivitis.
- c Herpes infection includes oral herpes, genital herpes simplex, herpes zoster and ophthalmic herpes zoster
- d Dizziness includes dizziness postural, vertigo and vertigo positional
- e Myalgia includes musculoskeletal pain and musculoskeletal chest pain

### **Eosinophilic Esophagitis**

A total of 321 adult and pediatric patients 12 to 17 years of age, weighing at least 40 kg, with EoE were evaluated in a randomized, double-blind, parallel-group, multicenter, placebo-controlled protocol consisting of two 24-week treatment studies (TREET Part A and TREET Part B). Patients completing the 24 weeks of the double-blind treatment period in Parts A or B were provided an option to enroll in a 28-week active treatment extension study (TREET Part C). The safety pool consisted of 239 patients in Parts A and B who received either Dupixent 300 mg QW or placebo.

In the safety pool, the proportion of patients who discontinued treatment due to adverse events was 1.7% of the placebo group and 2.5% of the Dupixent 300 mg QW group.

Table 9 summarizes the adverse reactions that occurred at a rate of at least 2% in patients treated with Dupixent and at a higher rate than in their respective comparator group in TREET Parts A and B.

**Table 9: Adverse Reactions Occurring in  $\geq$ 2% of DUPIXENT Group in TREET Parts A and B and at a greater frequency than Placebo (24-Week Safety Pool)**

Adverse Reaction	TREET Parts A and B	
	DUPIXENT 300 mg QW N=122 n (%)	Placebo N=117 n (%)
Injection site reactions <sup>a</sup>	46 (38%)	39 (33%)
Upper respiratory tract infections <sup>b</sup>	22 (18%)	12 (10%)
Arthralgia	3 (2%)	1 (1%)
Herpes viral infections <sup>c</sup>	3 (2%)	1 (1%)

<sup>a</sup> Injection site reactions are composed of several terms including, but not limited to, injection site swelling, pain, and bruising.

<sup>b</sup> Upper respiratory tract infections are composed of several terms including, but not limited to, COVID-19, sinusitis, and upper respiratory tract infection.

<sup>c</sup> Herpes viral infections are composed of oral herpes and herpes simplex.

### **Description of Selected Adverse Reactions**

#### ***Hypersensitivity***

Hypersensitivity reactions, including anaphylaxis and serum sickness or serum sickness-like reactions, have been reported in subjects receiving Dupixent (see WARNINGS AND PRECAUTIONS, Immune).

One serious case of anaphylaxis has been reported in the asthma development program following administration of Dupixent (see WARNINGS AND PRECAUTIONS, Immune).

### ***Eosinophils***

Subjects receiving Dupixent had a greater mean initial increase from baseline in blood eosinophil count compared to subjects receiving placebo in the atopic dermatitis, asthma, and CRSwNP indications. Blood eosinophil counts declined to near baseline levels during study treatment. Eosinophil counts continued to decline to near baseline levels during the open-label extension study in asthma patients.

Across atopic dermatitis, asthma, and CRSwNP indications, the incidence of treatment-emergent eosinophilia ( $\geq 500$  cells/mcL) was consistent in Dupixent and placebo groups. An increase from baseline in blood eosinophil count was not observed in subjects with EoE and in subjects with PN treated with Dupixent as compared to placebo.

Treatment-emergent eosinophilia ( $\geq 5,000$  cells/mcL) was reported in  $<3\%$  of subjects receiving Dupixent and  $<0.5\%$  in subjects receiving placebo (SOLO1, SOLO2, AD-1021, DRI12544, QUEST, VOYAGE, SINUS-24 and SINUS-52; TREET Parts A and B, PRIME and PRIME2 studies). Treatment-emergent eosinophilia ( $\geq 5,000$  cells/mcL) was reported in 8.4% of Dupixent-treated patients and 0% in placebo-treated patients in study AD-1539 in atopic dermatitis patients, with median eosinophil counts declining below baseline at end of treatment period (see WARNINGS AND PRECAUTIONS, Eosinophilic Conditions).

### ***Infections***

In atopic dermatitis, asthma, CRSwNP, and PN the rate of serious infections was consistent between subjects receiving Dupixent and subjects receiving placebo.

The overall incidence of infections or serious infections was consistent with Dupixent compared to placebo in the primary safety pool for atopic dermatitis clinical studies. In the 16-week monotherapy clinical studies primary safety pool, serious infections were reported in 1.0% of subjects treated with placebo and 0.5% of subjects treated with Dupixent. In the 52-week CHRONOS trial, serious infections were reported in 0.6% of subjects treated with placebo and 0.2% of subjects treated with Dupixent. The rates of serious infections remained stable at 148 weeks in the long-term OLE study (AD-1225).

The overall incidence of infections was consistent with Dupixent compared to placebo in the safety pool for asthma clinical studies. In the 24-week safety pool, serious infections were reported in 1.0% of subjects receiving Dupixent and 1.1% of subjects receiving placebo. In the 52-week QUEST study, serious infections were reported in 1.3% of subjects receiving Dupixent and 1.4% of subjects receiving placebo. In the 52-week VOYAGE study, serious infections were reported in 1.1% (3/271) of subjects receiving Dupixent and 2.2% (3/134) of subjects receiving placebo.

The overall incidence of infections was consistent with Dupixent compared to placebo in the safety pool for CRSwNP clinical studies. In the 24-week safety pool, serious infections were reported in 0.7% of subjects receiving Dupixent and 1.1% of subjects receiving placebo. In the 52-week SINUS-52 study, serious infections reported in 1.3% of subjects receiving Dupixent and 1.3% of subjects receiving placebo.

The overall incidence of infections was consistent with Dupixent compared to placebo in the safety pool for PN clinical studies. In the 24-week safety pool, serious infections were reported in 1.3% of patients treated with Dupixent and 1.3% of patients treated with placebo.

The overall incidence of infections was slightly elevated for Dupixent compared to placebo in the safety pool for EoE clinical studies. In the 24-week safety pool, infections were reported in 32.0% of subjects receiving Dupixent and 24.8% of subjects receiving placebo; serious infections were reported in 0.8% of patients treated with Dupixent and 0% of patients treated with placebo.

### ***Eczema Herpeticum and Herpes Zoster***

The rate of eczema herpeticum was consistent in the Dupixent and placebo groups in 16 week monotherapy studies. In the 52-week placebo-controlled CHRONOS trial, the incidence of eczema herpeticum in the Dupixent combined group was 0.2% and in the placebo group was 1.9%. The rates remained stable at 148 weeks in the long-term OLE trial (AD-1225).

Herpes zoster was reported in <0.1% of the Dupixent groups (<1%) and in <1% of the placebo group (1 per 100 subject-years) in the 16-week monotherapy trials. In the 52-week Dupixent + TCS trial, herpes zoster was reported in 1% of the Dupixent + TCS group (1 per 100 subject-years) and 2% of the placebo + TCS group (2 per 100 subject-years). During the long-term OLE trial with data up to 148 weeks (AD-1225), 1.9% of Dupixent-treated subjects reported herpes zoster (0.99 per 100 subject-years of follow up).

Among PN subjects, herpes zoster and ophthalmic herpes zoster were each reported in <1% of the Dupixent group (1 per 100 subject-years) and 0% of the placebo group.

### ***Conjunctivitis and Keratitis***

Conjunctivitis and keratitis related events occurred more frequently in atopic dermatitis patients who received Dupixent in the placebo controlled atopic dermatitis studies. Keratitis was reported in <1% of the Dupixent group (1 per 100 subject-years) in the 16-week monotherapy trials. In the 52-week Dupixent + topical corticosteroids (TCS) trial, keratitis was reported in 4% of the Dupixent + TCS group (12 per 100 subject-years). In the long-term OLE trial (AD-1225) through 148 weeks, keratitis was reported in 3% of the Dupixent group (2 per 100 subject-years).

During the 52-week treatment period of concomitant therapy trial (CHRONOS) in subjects with atopic dermatitis, conjunctivitis was reported in 16% of the Dupixent 300 mg Q2W + TCS group (20 per 100 subject-years) and in 9% of the placebo + TCS group (10 per 100 subject-years). During the long-term OLE trial (AD-1225) with data through 148 weeks, conjunctivitis was reported in 20% of the Dupixent group (12 per 100 subject-years). Most patients with conjunctivitis or keratitis recovered or were recovering during the treatment period.

Among asthma subjects, the frequency of conjunctivitis was low and consistent between Dupixent and placebo.

In subjects with CRSwNP, the frequency of conjunctivitis was 2% in the Dupixent group compared to 1% in the placebo group in the 24-week safety pool; these subjects recovered. During the 52-week treatment period of subjects with CRSwNP (SINUS-52), conjunctivitis was reported in 3% of subjects receiving Dupixent and in 1% of subjects receiving placebo; all of these subjects recovered. There were no cases of keratitis reported in the CRSwNP development program (see WARNINGS AND PRECAUTIONS).

Among subjects with PN, the frequency of conjunctivitis was 4% in the Dupixent group compared to 1% in the placebo group in the safety pool; all of these subjects recovered or were recovering during the treatment period. There were no cases of keratitis reported in the PN development program (see WARNINGS AND PRECAUTIONS).

Among patients with EoE, the frequency of conjunctivitis was low and similar between dupilumab and placebo groups. There were no cases of keratitis in the EoE development program.

### **Immunogenicity**

As with all therapeutic proteins, there is a potential for immunogenicity with dupilumab. The observed incidence of persistent ADA responses and neutralizing activity in the assay are highly dependent on the sensitivity and specificity of the assay used. Additionally, the observed incidence of antibody

positivity in an assay may be influenced by several factors, including assay methodology, sample handling, timing of sample collection, concomitant medications, and underlying disease status of the individual patient. For these reasons, comparison of the incidence of antibodies to Dupixent with the incidence of antibodies to other products may be misleading.

Approximately 5% of subjects with atopic dermatitis, asthma or CRSwNP who received Dupixent 300 mg Q2W for 52 weeks developed anti-drug antibodies (ADA) to dupilumab; approximately 2% exhibited persistent ADA responses and approximately 2% had neutralizing antibodies. Similar results were observed in pediatric patients (6 months to 11 years of age) with atopic dermatitis who received either Dupixent 200 mg Q2W, 200 mg Q4W or 300 mg Q4W.

Approximately 16% of adolescent subjects (12-17 years of age) with atopic dermatitis who received Dupixent 300 mg or 200 mg Q2W for 16 weeks developed antibodies to dupilumab; approximately 3% exhibited persistent ADA responses, and approximately 5% had neutralizing antibodies.

Approximately 9% of adults and adolescent subjects (12-17 years of age) with asthma who received Dupixent 200 mg Q2W for 52 weeks developed antibodies to dupilumab; approximately 4% exhibited persistent ADA responses and approximately 4% had neutralizing antibodies.

Approximately 3 to 6% of pediatric subjects (6-11 years of age) with atopic dermatitis who received Dupixent 200 mg Q2W or 300 mg Q4W for 16 weeks, and with asthma who received Dupixent 100 mg Q2W or 200 mg Q2W for 52 weeks developed antibodies to dupilumab; approximately 0 to 3% exhibited persistent ADA responses, and approximately 1 to 2% had neutralizing antibodies.

Approximately 1% of pediatric subjects (6 months-5 years of age) with atopic dermatitis who received Dupixent 200 mg or 300 mg Q4W for 16 weeks developed antibodies to dupilumab; neutralizing antibodies were not observed.

Approximately 8% of patients with PN who received Dupixent 300 mg Q2W for 24 weeks developed antibodies to dupilumab; approximately 1% exhibited persistent ADA responses, and approximately 3% had neutralizing antibodies.

Approximately 1% of patients with EoE who received Dupixent 300 mg QW for 24 weeks developed antibodies to dupilumab.

Regardless of age or population, up to 4% of subjects in the placebo groups were positive for antibodies to Dupixent; approximately 2% exhibited persistent ADA responses and approximately 1% had neutralizing antibodies.

ADA responses were not generally associated with impact on Dupixent exposure, safety, or efficacy. Less than 1% of subjects who received Dupixent at approved dosing regimens exhibited high titer ADA responses associated with reduced exposure and efficacy. Two subjects who experienced high titer antibody responses developed serum sickness or serum sickness-like reactions during treatment with Dupixent (see WARNINGS AND PRECAUTIONS, Immune).

### **8.5 Post-Market Adverse Reactions**

The following additional adverse reactions have been identified during post-approval use of Dupixent. The adverse reactions are derived from spontaneous reports and therefore, the frequency is “not known” (cannot be estimated from the available data).

- *Immune system disorders:*
  - Angioedema
- *Musculoskeletal and connective tissue disorders:*
  - Arthralgia



- *Skin and subcutaneous tissue disorders:*
  - Facial rash
- *Eye disorders:*
  - Keratitis, ulcerative keratitis

## **9. DRUG INTERACTIONS**

### **9.4 Drug-Drug Interactions**

#### **Interactions with CYP450 Substrates**

In a clinical trial with 12-13 evaluable subjects with atopic dermatitis, the effects of dupilumab injection on the pharmacokinetics of caffeine (metabolized by CYP1A2), warfarin (metabolized by CYP2C9), omeprazole (metabolized by CYP2C19), metoprolol (metabolized by CYP2D6), and midazolam (metabolized by CYP3A4) were evaluated. The AUC of metoprolol increased by 29% after dupilumab injection administration (a SC loading dose of 600 mg followed by 300 mg SC weekly for 6 weeks). The AUC of other CYP substrates investigated were comparable before and after dupilumab injection administration.

#### **Use with Other Drugs for Treatment of Asthma**

An effect of dupilumab on the pharmacokinetics of co-administered medications is not expected. Based on the population pharmacokinetic analysis, commonly co-administered medications had no effect on dupilumab pharmacokinetics in subjects with moderate to severe asthma.

#### **Drug-Vaccine Interactions**

##### ***Live Vaccines***

Dupixent has not been studied with live vaccines. Live vaccines should not be given concurrently with Dupixent.

##### ***Non-Live Vaccines***

Immune responses to vaccination were assessed in a study in which subjects with atopic dermatitis were treated once weekly for 16 weeks with 300 mg of dupilumab injection. After 12 weeks of dupilumab injection administration, subjects were vaccinated with a Tdap vaccine (T cell-dependent, Adacel<sup>®</sup>) and a meningococcal polysaccharide vaccine (T cell-independent, Menomune<sup>®</sup>) and immune responses were assessed 4 weeks later. Antibody responses to both tetanus vaccine and meningococcal polysaccharide vaccine were similar in dupilumab injection -treated and placebo-treated subjects. No adverse interactions between either of the non-live vaccines and dupilumab injection were noted in the study.

### **9.5 Drug-Food Interactions**

Interactions with food have not been established.

### **9.6 Drug-Herb Interactions**

Interactions with herbal products have not been established.

### **9.7 Drug-Laboratory Test Interactions**

Interactions with laboratory tests have not been established.

## 10. CLINICAL PHARMACOLOGY

### 10.1 Mechanism of Action

Dupilumab is a recombinant human IgG4 monoclonal antibody that inhibits interleukin-4 (IL-4) and interleukin-13 (IL-13) signaling by specifically binding to the IL-4R $\alpha$  subunit shared by the IL-4 and IL-13 receptor complexes. Dupilumab inhibits IL-4 signaling via the Type I receptor (IL-4R $\alpha$ / $\gamma$ c), and both IL-4 and IL-13 signaling through the Type II receptor (IL-4R $\alpha$ /IL-13R $\alpha$ ).

IL-4 and IL-13 are key type 2 (including Th2) cytokines involved in atopic disease.

Type 2 inflammation is an important component in the pathogenesis of asthma, atopic dermatitis, CRSwNP, PN and EoE. Multiple cell types that express IL-4R $\alpha$  (e.g., mast cells, eosinophils, macrophages, lymphocytes, epithelial cells, goblet cells) and inflammatory mediators (e.g., histamine, eicosanoids, leukotrienes, cytokines, chemokines) are involved in inflammation. Blocking IL-4R $\alpha$  with dupilumab inhibits IL-4 and IL-13 cytokine-induced inflammatory responses, including the release of pro-inflammatory cytokines, chemokines, nitric oxide, and IgE; however, the mechanism of dupilumab action in asthma has not been definitively established.

### 10.2 Pharmacodynamics

#### Atopic Dermatitis

In clinical trials that enrolled subjects with atopic dermatitis, treatment with Dupixent was associated with decreases from baseline in concentrations of type 2-associated biomarkers, such as thymus and activation-regulated chemokine (TARC/CCL17), total serum IgE, and allergen-specific IgE in serum. A reduction of lactate dehydrogenase (LDH), a biomarker associated with AD disease activity and severity, was observed with Dupixent treatment.

Dupixent suppressed TARC relative to placebo as early as week 2, with a trend of continued decline to a maximal and sustained suppression by Week 12. The majority of subjects treated with Dupixent in the CHRONOS study (87.0% of subjects in the Dupixent 300 mg Q2W group) achieved normalized TARC levels compared to 20.0% in the placebo group at week 52.

Total IgE was reduced -74.8% by Week 52 (median change from baseline) with Dupixent 300 mg Q2W, compared to a 0% reduction in the placebo group. Consistent trends were observed for allergen specific IgEs. After 52 weeks of treatment, total IgE was normalized in 11.7% of subjects receiving Dupixent 300 mg Q2W, respectively compared to 4.4% in the placebo group. Consistent trends were observed with antigen-specific IgEs, including *S. aureus* specific enterotoxin A, grass and tree allergens.

#### Asthma

Consistent with inhibition of IL-4 and IL-13 signaling, dupilumab decreased FeNO and circulating concentrations of eotaxin-3, total IgE, allergen specific IgE, TARC, and periostin relative to placebo, in subjects with severe asthma. These reductions in biomarkers of inflammation were consistent for the 200 mg Q2W and 300 mg Q2W regimens, with near maximal reduction observed after 2 weeks of exposure to dupilumab, except for IgE, which declined more slowly. These reductions in biomarkers were sustained throughout treatment.

### 10.3 Pharmacokinetics

The pharmacokinetics of dupilumab are consistent between subjects with atopic dermatitis, asthma, CRSwNP, PN and EoE.

**Table 10 - Summary of steady-state dupilumab pharmacokinetic parameters in patients with atopic dermatitis, asthma, CRSwNP, PN, and EoE**

Dose Regimen	Age Group	AUC <sub>4wk,ss</sub> <sup>a,c</sup> (mg day/L)	C <sub>max,ss</sub> <sup>a,c</sup> (mg/L)	C <sub>trough,ss</sub> <sup>a,c</sup> (mg/L)	T <sub>max</sub> <sup>b</sup> (day)	V <sub>d</sub> <sup>c</sup> (L)
300 mg qw	Adults and Adolescents <sup>d</sup>	5360 (2180)	211 (85)	198 (83)	2-7	3.1-4.9
300 mg q2w		2070 (896)-2404(912)	83.6 (34.5)-95.1 (39.4)	60.4 (29.5)-72.5 (30.3)		
200 mg q2w		1192 (672)-2031 (691)	50.1 (25.3)-83.5 (27.2)	38.9 (23.1)-57.7 (22.3)		
200 mg q2w	6 to 11 Years <sup>d</sup>	2902 (1030)-3306 (1062)	114 (38.4)-135 (41.6)	86.6 (34.0)-95.3 (34.6)	1.7-2.9	1.3-1.5
300 mg q4w		2143 (884)-3845 (1286)	102 (35.5)-189 (49.7)	48.0 (26.5)-98.7 (41.0)		
100 mg q2w		1984 (722)	77.5 (26.7)	59.8 (23.7)		
300 mg q4w	6 Months to 5 Years <sup>d</sup>	4495 (1402)	230 (57.1)	111 (46.5)		
200 mg q4w		4506 (1465)	224 (56.0)	123 (52.3)		

<sup>a</sup>range of mean(SD); <sup>b</sup>range of median; <sup>c</sup>estimated by population PK analysis; <sup>d</sup>adults and adolescents with atopic dermatitis asthma or EoE, and adults with CRSwNP and PN, children 6 to 11 years with atopic dermatitis or asthma, and children 6 months to 5 years with atopic dermatitis

AUC<sub>4wk,ss</sub>: area under the concentration time curve over 4 weeks interval at steady state; C<sub>max,ss</sub>: maximum concentration at steady state; C<sub>trough,ss</sub>: trough concentration at steady state; T<sub>max</sub>: times to maximum concentration; V<sub>d</sub>= volume of distribution

#### Absorption

After a single subcutaneous (SC) dose of 75-600 mg dupilumab, median times to maximum concentration in serum (t<sub>max</sub>) were 3-7 days. The absolute bioavailability of dupilumab following a SC dose is consistent between AD, asthma, CRSwNP, PN and EoE subjects, ranging from 61% and 64%, as determined by a population pharmacokinetic (PK) analysis.

In adults with AD, CRSwNP or PN, as well as adults and adolescents with asthma, for every-other-week dosing (Q2W) with either 200 mg or 300 mg, starting with a respective loading dose of 400 mg or 600 mg, or with 300 mg without a loading dose, population PK analysis determined steady-state concentrations to be achieved by 16 weeks. Mean steady state trough concentrations were 29-37 mg/L at 200 mg Q2W and 60-80 mg/L at 300 mg Q2W. The mean steady state trough concentration was 172-195 mg/L at 300 mg QW for adults with EoE.

#### Dose Linearity

Due to nonlinear clearance, dupilumab exposure, as measured by area under the concentration-time curve (AUC), increases with dose in a greater than proportional manner following single SC doses from 75 mg (AUC of 59.2 mg day/L) to 600 mg (AUC of 1780 mg day/L).

**Distribution:**

A volume of distribution for dupilumab of approximately 4.6 L was estimated by population PK analysis.

**Metabolism:**

Specific metabolism studies were not conducted because dupilumab is a protein. Dupilumab is expected to degrade to small peptides and individual amino acids.

**Elimination:**

Dupilumab elimination is mediated by parallel linear and nonlinear pathways. At higher concentrations, dupilumab elimination is primarily through a non-saturable proteolytic pathway, while at lower concentrations, the non-linear saturable IL-4R $\alpha$  target-mediated elimination predominates.

After the last steady state dose of 300 mg QW, 300 mg Q2W, 200 mg Q2W, 300 mg Q4W, or 200 mg Q4W dupilumab, the median times to washout of dupilumab, determined by population PK analysis, ranged from 9-13 weeks in adults and adolescents and are approximately 1.5 times and 2.5 times longer in pediatric subjects 6 to 11 years of age and pediatric subjects less than 6 years of age, respectively.

**-Special Populations and Conditions**

- **Pediatrics:**

- Atopic Dermatitis

- Adolescents (12 to 17 years of age)

- For adolescents 12 to 17 years of age with moderate-to-severe atopic dermatitis that received Q2W dosing with either 200 mg (<60 kg) or 300 mg ( $\geq$ 60 kg), the mean  $\pm$ SD steady-state trough concentration of dupilumab was 54.5 $\pm$ 27.0 mg/L.

- Pediatrics (6 to 11 years of age)

- For children 6 to 11 years of age with severe atopic dermatitis Q2W dosing with 200 mg ( $\geq$ 30 kg) or Q4W dosing with 300 mg (<30 kg), the mean  $\pm$  SD steady-state trough concentration of dupilumab was 86.0 $\pm$ 34.6 mg/L and 98.7 $\pm$ 33.2 mg/L, respectively.

- Pediatrics (6 months to 5 years of age)

- For children 6 months to 5 years of age with atopic dermatitis receiving every four week dosing (Q4W) with 300 mg ( $\geq$ 15 to <30 kg) or 200 mg ( $\geq$ 5 to <15 kg) mean  $\pm$  SD steady-state trough concentration was 110 $\pm$ 42.8 mcg/mL and 109 $\pm$ 50.8 mcg/mL, respectively.

- Asthma

- Adolescents (12 to 17 years of age)

- A total of 107 adolescents aged 12 to 17 years with moderate to severe asthma were enrolled in QUEST study and received either 200 mg (n=21) or 300 mg (n=18) dupilumab (or matching placebo either 200 mg [n=34] or 300 mg [n=34]) every-other-week. The mean  $\pm$ SD steady-state trough concentration of dupilumab was 46.7 $\pm$ 26.9 mcg/mL or 107 $\pm$  51.6 mcg/mL, respectively,

for 200 mg or 300 mg administered every–other-week.

#### Pediatrics (6 to 11 years of age)

In the VOYAGE study, dupilumab pharmacokinetics was investigated in 270 patients with moderate-to-severe asthma following subcutaneous administration of either 100 mg Q2W (for 91 children weighing <30 kg) or 200 mg Q2W (for 179 children weighing ≥30 kg). The mean ± SD steady-state trough concentration was 58.4±28.0 mcg/mL and 85.1±44.9 mcg/mL, respectively. Simulation of a 300 mg Q4W subcutaneous dose in children aged 6 to 11 years with body weight of ≥15 to <30 kg and ≥30 to <60 kg resulted in predicted steady-state trough concentrations was 98.7±41.0 mcg/mL and 48.0±26.5 mcg/mL, respectively.

#### Chronic rhinosinusitis with nasal polyposis

The pharmacokinetics of dupilumab has not been studied in pediatric patients (<18 years of age) with CRSwNP.

#### Eosinophilic Esophagitis

A total of 35 adolescents aged 12 to 17 years with eosinophilic esophagitis weighing ≥40 kg were enrolled in TREET Part A and Part B, receiving 300 mg every week dosing (QW). The mean ± SD steady-state trough concentration of dupilumab was 227 ± 95.3 mcg/mL.

#### PN

The pharmacokinetics of dupilumab have not been studied in pediatric patients (< 18 years of age) with PN.

- **Geriatrics**

#### Atopic Dermatitis

In subjects with atopic dermatitis who were 65 years and older, the mean steady-state trough concentrations of dupilumab were 69.4 mg/L and 166 mg/L, respectively, for 300 mg administered every 2 weeks and weekly. No dose adjustment in this population is recommended.

#### Asthma

Of the 1977 subjects with asthma exposed to dupilumab, a total of 240 subjects were 65 years or older and 39 subjects were 75 years or older. No dose adjustment in this population is recommended.

#### Chronic Rhinosinusitis with Nasal Polyposis

Of the 440 subjects with CRSwNP exposed to dupilumab, a total of 79 were 65 years and older and 11 subjects were 75 years and older. No dose adjustment in this population is recommended.

#### Eosinophilic Esophagitis

Of 203 subjects with EoE exposed to DUPIXENT in the phase 3 study, a total of 2 were 65 years of age or older. Clinical studies of Dupixent in EoE did not include sufficient numbers of patients aged 65 years and over to determine whether they respond differently from younger patients.

### Prurigo Nodularis

Of the 152 subjects with PN exposed to dupilumab, a total of 37 were 65 years or older and 8 subjects were 75 years or older. No dose adjustment in this population is recommended.

- **Sex:** Sex was not found to be associated with any clinically meaningful impact on the systemic exposure of dupilumab as determined by population PK analysis.
- **Age:** Age was not found to be associated with any clinically meaningful impact on the systemic exposure of dupilumab in adults and in pediatric patients 6 to 17 years of age as determined by population PK analysis. In pediatric patients 6 months to 5 years of age, clearance increased with age as determined by population PK analysis.
- **Race:** Race was not found to be associated with any clinically meaningful impact on the systemic exposure of dupilumab as determined by population PK analysis.
- **Hepatic Insufficiency:** No clinical studies have been conducted to evaluate the effect of hepatic impairment on the pharmacokinetics of dupilumab.
- **Renal Insufficiency:** No clinical studies have been conducted to evaluate the effect of renal impairment on the pharmacokinetics of dupilumab. Population PK analysis did not identify mild or moderate renal impairment as having a clinically meaningful influence on the systemic exposure of dupilumab. No data are available in patients with severe renal impairment.
- **Body Weight:** Dupilumab trough concentrations were lower in subjects with higher body weight as determined by population-PK analysis.

## **11. STORAGE, STABILITY AND DISPOSAL**

Store refrigerated at 2°C to 8°C in the original carton to protect from light.

Do not freeze.

Do not expose to heat.

Do not shake.

Do not use beyond the expiry date stamped on the carton and container label.

## **12. SPECIAL HANDLING INSTRUCTIONS**

The patient may either self-inject Dupixent, or a caregiver may administer Dupixent, after guidance has been provided by a healthcare professional on proper subcutaneous injection technique.

Parenteral drug products should be inspected visually for particulate matter and discoloration prior to administration. If the solution is discolored or contains visible particulate matter, the solution should not be used.

The 300 mg pre-filled syringe with a needle shield, pre-filled syringe or pre-filled pen should be allowed to reach room temperature by waiting for 45 min before injecting Dupixent.

The 200 mg pre-filled syringe with a needle shield, or pre-filled pen should be allowed to reach room temperature by waiting for 30 min before injecting Dupixent.

If necessary, pre-filled syringes or pens may be kept at room temperature up to 25°C for a maximum of 14 days. Do not store above 25°C. After removal from the refrigerator, Dupixent must be used within 14 days or discarded.

The pre-filled syringe or pen should not be exposed to heat or direct sunlight.

In the absence of compatibility studies, this medicinal product must not be mixed with other medicinal products.

Any unused medicinal product or waste material should be disposed of in accordance with local requirements.

## PART II: SCIENTIFIC INFORMATION

### 13. PHARMACEUTICAL INFORMATION

#### Drug Substance

Proper name: Dupilumab

Molecular mass: 147 kDa.

#### Product Characteristics:

Dupixent (dupilumab injection) is a fully human IgG4 monoclonal antibody produced by recombinant DNA technology in Chinese Hamster Ovary cell suspension culture.

Dupixent inhibits interleukin-4 (IL-4) and interleukin-13 (IL-13) signaling by specifically binding to the IL-4R $\alpha$  subunit shared by the IL-4 and IL-13 receptor complexes. Dupixent inhibits IL-4 signaling via the Type I receptor (IL-4R $\alpha$ / $\gamma$ c), and both IL-4 and IL-13 signaling through the Type II receptor (IL-4R $\alpha$ /IL-13R $\alpha$ ).

Dupilumab is a covalent heterotetramer consisting of two disulfide-linked human heavy chains, each covalently linked through a disulfide bond to a human kappa light chain. There is a single N-linked glycosylation site in each heavy chain, located within the CH2 domain of the Fc constant region of the molecule. The Dupixent heavy chain has an immunoglobulin (Ig) G4P isotype constant region. IgG4P is an IgG4 constant region with a single amino acid substitution in the hinge region that recreates the IgG1 hinge sequence in order to stabilize IgG4 dimer formation. The variable domains of the heavy and light chains combine to form the IL-4R $\alpha$  binding site within the antibody.



## 14. CLINICAL TRIALS

### 14.1 Trial Design and Study Demographics

#### **14.1.1 - Trial design and demographics: Atopic Dermatitis in adults**

Three randomized, double-blind, placebo-controlled trials (SOLO 1, SOLO 2, and CHRONOS) enrolled a total of 2119 subjects 18 years of age and older with moderate-to-severe atopic dermatitis (AD) not adequately controlled by topical medication(s). Disease severity was defined by an Investigator's Global Assessment (IGA) score  $\geq 3$  in the overall assessment of AD lesions on a severity scale of 0 to 4, an Eczema Area and Severity Index (EASI) score  $\geq 16$  on a scale of 0 to 72, and a minimum body surface area involvement of  $\geq 10\%$ . At baseline, 59% of subjects were male, 67% were white, 52% of subjects had a baseline IGA score of 3 (moderate AD), and 48% of subjects had a baseline IGA of 4 (severe AD). The baseline mean EASI score was 33 and the baseline weekly averaged peak pruritus Numeric Rating Scale (NRS) was 7 on a scale of 0-10.

In all three trials, subjects in the Dupixent (dupilumab) group received subcutaneous injections of Dupixent 600 mg at Week 0, followed by 300 mg every other week (Q2W). In the monotherapy trials (SOLO 1 and SOLO 2), subjects received Dupixent or placebo for 16 weeks.

In the concomitant therapy trial (CHRONOS), subjects received Dupixent or placebo with concomitant topical corticosteroids (TCS) and as needed topical calcineurin inhibitors for problem areas only, such as the face, neck, intertriginous and genital areas for 52 weeks.

All three trials assessed the primary endpoint, the change from baseline to Week 16 in the proportion of subjects with an IGA 0 (clear) or 1 (almost clear) and at least a 2-point improvement. Other endpoints included the proportion of subjects with EASI-75 (improvement of at least 75% in EASI score from baseline), and reduction in itch as defined by at least a 4 point improvement in the peak pruritus NRS from baseline to Week 16.

**Table 11– Summary of patient demographics for clinical trials in adults with moderate-to-severe atopic dermatitis (AD)**

Study #	Trial design	Dosage, route of administration and duration	Study subjects (n = number)	Mean age (Range)	Gender
<b>SOLO 1</b>	Randomized, double-blind, placebo-controlled, parallel group, in adults with moderate-to-severe AD	Subcutaneous: dupilumab injection vs. placebo - Dupilumab injection: 600 mg loading dose, then 300 mg Q2W or 300 mg QW - Placebo 16 weeks	Dupilumab injection: - 300 mg Q2W: n = 224 - 300 mg QW: n = 223 Placebo: n = 224	39.5 (18-85)	M: 58.1% F: 41.9%

**Table 11– Summary of patient demographics for clinical trials in adults with moderate-to-severe atopic dermatitis (AD)**

<b>Study #</b>	<b>Trial design</b>	<b>Dosage, route of administration and duration</b>	<b>Study subjects (n = number)</b>	<b>Mean age (Range)</b>	<b>Gender</b>
<b>SOLO 2</b>	Randomized, double-blind, placebo-controlled, parallel group, in adults with moderate-to-severe AD	Subcutaneous: dupilumab injection vs. placebo - Dupilumab injection: 600 mg loading dose, then 300 mg Q2W or 300 mg QW - Placebo 16 weeks	Dupilumab injection: - 300 mg Q2W: n = 233 - 300 mg QW: n = 239 Placebo: n = 236	37.1 (18-88)	M: 57.6% F: 42.4%
<b>CHRONOS</b>	Randomized, double-blind, placebo-controlled, parallel group, in adults with moderate-to-severe AD	Dupilumab injection + topical corticosteroids (TCS) vs. placebo+TCS* Subcutaneous: - Dupilumab injection: 600 mg loading dose, then 300 mg Q2W or 300 mg QW - Placebo 52 weeks	Dupilumab injection: - 300 mg Q2W: n = 106 - 300 mg QW: n = 319 Placebo: n = 315	37.1 (18-81)	M: 60.3% F: 39.7%

\* Subjects received Dupixent or placebo with concomitant use of TCS starting at baseline using a standardized regimen. Subjects were also permitted to use topical calcineurin inhibitors (TCI)  
Q2W: every other week; QW: weekly

#### **14.1.2 - Trial design and demographics: Atopic Dermatitis in pediatrics (6 to 11 years of age)**

The efficacy and safety of Dupixent in pediatric patients treated concomitantly with TCS was evaluated in a multicentre, randomized, double-blind, placebo-controlled trial (AD-1652) in 367 subjects 6 to 11 years of age, with AD defined by an IGA score of 4 (scale of 0 to 4), an EASI score  $\geq 21$  (scale of 0 to 72), and a minimum BSA involvement of  $\geq 15\%$ . Eligible subjects enrolled into this trial had previous inadequate response to topical medication. Enrollment was stratified by baseline weight ( $<30$  kg;  $\geq 30$  kg).

Subjects in the Dupixent Q2W + TCS group with baseline weight of  $<30$  kg received an initial dose of 200 mg on Day 1, followed by 100 mg Q2W from Week 2 to Week 14, and subjects with baseline weight of  $\geq 30$  kg received an initial dose of 400 mg on Day 1, followed by 200 mg Q2W from week 2 to week 14. Subjects in the Dupixent Q4W + TCS group received an initial dose of 600 mg on Day 1, followed by 300 mg Q4W from week 4 to week 12, regardless of weight. Subjects were permitted to receive rescue treatment at the discretion of the investigator. Subjects who received rescue treatment were considered non-responders.

The mean age of subjects was 8.5 years, the median weight was 29.8 kg, 50.1% of patients were female, 69.2% were White, 16.9% were Black, and 7.6% were Asian. At baseline, the mean BSA involvement was 57.6%, and prior systemic non-steroidal immunosuppressants were utilized by 16.9% of subjects. Also, at baseline the mean EASI score was 37.9, and the weekly average of daily worst itch score was 7.8 on a scale of 0-10, the baseline mean SCORAD score was 73.6, the baseline POEM score was 20.9, and the baseline mean CDLQI was 15.1. Overall, 91.7% of subjects had at least one co-morbid allergic condition; 64.4% had food allergies, 62.7% had other allergies, 60.2% had allergic rhinitis, and 46.7% had asthma.

The primary endpoint was the proportion of subjects with an IGA 0 (clear) or 1 (almost clear) at week 16. Other evaluated outcomes included the proportion of subjects with EASI-75 or EASI-90 (improvement of at least 75% or 90% in EASI from baseline, respectively), percent change in EASI score from baseline to week 16, and reduction in itch as measured by the peak pruritus NRS ( $\geq 4$ -point improvement). Additional secondary endpoints included mean change from baseline to week 16 in the POEM and CDLQI scores.

#### **14.1.3 Trial design and demographics: Atopic Dermatitis in pediatrics (6 months to 5 years of age)**

The efficacy and safety of Dupixent use concomitantly with TCS in pediatric patients was evaluated in a multicenter, randomized, double-blind, placebo-controlled trial (AD-1539) in 162 patients 6 months to 5 years of age, with moderate-to-severe AD defined by an IGA score  $\geq 3$  (scale of 0 to 4), an EASI score  $\geq 16$  (scale of 0 to 72), and a minimum BSA involvement of  $\geq 10\%$ . Eligible patients enrolled into this trial had previous inadequate response to topical medication. Enrollment was stratified by baseline weight ( $\geq 5$  to  $<15$  kg and  $\geq 15$  to  $<30$  kg).

Patients in the Dupixent Q4W + TCS group with baseline weight of  $\geq 5$  to  $<15$  kg received an initial dose of 200 mg on Day 1, followed by 200 mg Q4W from Week 4 to Week 12, and patients with baseline weight of  $\geq 15$  to  $<30$  kg received an initial dose of 300 mg on Day 1, followed by 300 mg Q4W from Week 4 to Week 12. Patients were permitted to receive rescue treatment at the discretion of the investigator. Patients who received rescue treatment were considered non-responders.

In AD-1539, the mean age was 3.8 years, the median weight was 16.5 kg, 38.9% of patients were female, 68.5% were White, 18.5% were Black, and 6.2% were Asian. At baseline, the mean BSA involvement was 58.4%, and 29% had received prior systemic non-steroidal immunosuppressants. Also, at baseline the mean EASI score was 34.1, and the weekly average of daily worst itch score was 7.6 on a

scale of 0-10. Overall, 81.4% of patients had at least one co-morbid allergic condition; 68.3% had food allergies, 52.8% had other allergies, 44.1% had allergic rhinitis, and 25.5% had asthma.

The primary endpoint was the proportion of patients with an IGA 0 (clear) or 1 (almost clear) at Week 16. Other evaluated outcomes included the proportion of patients with EASI-75 or EASI-90 (improvement of at least 75% or 90% in EASI from baseline, respectively), and reduction in itch as measured by the Worst Scratch/Itch NRS ( $\geq 4$ -point improvement).

#### **14.1.4 Trial design and demographics: Asthma in adults and adolescents (aged 12 years and older)**

The asthma development program for patients aged 12 years and older included three randomized, double-blind, placebo-controlled, parallel-group, multi-centre studies (DRI12544, QUEST, and VENTURE) of 24 to 52 weeks in treatment duration. Patients were enrolled without requiring a minimum baseline blood eosinophil or other type 2 inflammatory biomarkers (e.g. FeNO or IgE) level

##### DRI12544

DRI12544 was a 24-week dose-ranging study that included 776 subjects (18 years of age and older). Dupixent compared with placebo was evaluated in adult patients with asthma receiving medium-or-high dose inhaled corticosteroid and a long-acting beta agonist. Subjects were randomized to receive either 200 mg (n= 150) or 300 mg (n= 157) Dupixent every-other-week or 200 mg (n= 154) or 300 mg (n= 157) Dupixent every 4 weeks following an initial dose of 400 mg, 600 mg, or placebo (n= 158), respectively. The primary analysis population was subjects with baseline blood eosinophil count of  $\geq 300$  cells/mcL. The primary endpoint was change from baseline to Week 12 in FEV1 (L). Annualized rate of severe asthma exacerbation events during the 24-week placebo controlled treatment period was also determined as described in QUEST.

##### QUEST

QUEST was a 52-week study that included 1902 subjects (12 years of age and older). Dupixent compared with placebo was evaluated in 107 adolescent and 1795 adult subjects with asthma receiving medium- or high- dose inhaled corticosteroid (ICS) and one or two additional controller medications (e.g., long-acting beta agonists). Subjects were randomized to receive either 200 mg (n=631) or 300 mg (n=633) Dupixent every-other-week (or matching placebo for either 200 mg [n = 317] or 300 mg [n= 321] every-other-week) following an initial dose of 400 mg, 600 mg, or placebo, respectively. The primary endpoints were the annualized rate of severe exacerbation events during the 52-week placebo-controlled period and change from baseline in pre-bronchodilator FEV1 at Week 12. A severe exacerbation was defined as a deterioration of asthma requiring the use of systemic corticosteroids for at least 3 days or hospitalization or emergency room visit due to asthma that required systemic corticosteroids.

##### VENTURE

VENTURE was a 24-week oral corticosteroid (OCS) reduction study in 210 subjects with asthma receiving high-dose inhaled corticosteroids plus additional controller(s) (e.g., LABA). All subjects were receiving OCS; the mean baseline daily OCS dose was 11 mg in subjects receiving Dupixent and 12 mg in subjects receiving placebo. The number of subjects receiving 5 mg OCS as the optimized OCS dose at randomization was limited to approximately 30% of the study population. After optimizing the OCS dose during the screening period, subjects were randomized to receive 300 mg Dupixent (n=103) or placebo (n=107) once every-other-week for 24 weeks following an initial dose of 600 mg or placebo. Subjects continued to receive their existing asthma medicine during the study; however, their OCS dose was reduced every 4 weeks during the OCS reduction phase (Week 4-20), if asthma control was maintained. Asthma control was maintained if subjects did not experience i) an increase in ACQ-5  $\geq 0.5$

units, ii) a severe asthma exacerbation, or iii) a clinically significant event that required OCS dose adjustment. The primary endpoint was the percent reduction of OCS dose at Weeks 20 to 24 compared with the baseline dose, while maintaining asthma control.

The demographics and baseline characteristics of these 3 trials are provided in **Table 12**

**Table 12 – Demographics and Baseline Characteristics of Asthma Trials**

Parameter	DRI12544 (n = 776)	QUEST (n = 1902)	VENTURE (n=210)
Mean age (years) (SD)	48.6 (13.0)	47.9 (15.3)	51.3 (12.6)
% Female	63.1	62.9	60.5
% White	78.2	82.9	93.8
Duration of Asthma (years), mean (± SD)	22.03 (15.42)	20.94 (15.36)	19.95 (13.90)
Never smoked, (%)	77.4	80.7	80.5
Mean exacerbations in previous year (± SD)	2.17 (2.14)	2.09 (2.15)	2.09 (2.16)
High dose ICS use (%)	49.5	51.5	88.6
Pre-dose FEV <sub>1</sub> (L) at baseline (± SD)	1.84 (0.54)	1.78 (0.60)	1.58 (0.57)
Mean percent predicted FEV <sub>1</sub> (%) (±SD)	60.77 (10.72)	58.43 (13.52)	52.18 (15.18)
% Reversibility (± SD)	26.85 (15.43)	26.29 (21.73)	19.47 (23.25)
Mean ACQ-5 score (± SD)	2.74 (0.81)	2.76 (0.77)	2.50 (1.16)
Mean AQLQ score (± SD)	4.02 (1.09)	4.29 (1.05)	4.35 (1.17)
Atopic Medical History % Overall (AD %, NP %, AR %)	72.9 (8.0, 10.6, 61.7)	77.7 (10.3, 12.7, 68.6)	72.4 (7.6, 21.0, 55.7)
Mean FeNO ppb (± SD)	39.10 (35.09)	34.97 (32.85)	37.61 (31.38)
Mean total IgE IU/mL (± SD)	435.05 (753.88)	432.40 (746.66)	430.58 (775.96)
Mean blood eosinophil count (± SD) cells/mcL	350 (430)	360 (370)	350 (310)

ICS = inhaled corticosteroid; LABA = Long-acting beta2-agonist; FEV<sub>1</sub> = Forced expiratory volume in 1 second; ACQ-5 = Asthma Control Questionnaire-5; AQLQs = Asthma Quality of Life Questionnaire, Standardized Version; AD = atopic dermatitis; NP = nasal polyposis; AR = allergic rhinitis; FeNO = fraction of exhaled nitric oxide.

#### **14.1.5 Trial design and demographics: Asthma in pediatrics (6 to 11 years of age)**

The efficacy and safety of Dupixent in children was evaluated in a 52-week multicenter, randomized, double-blind, placebo-controlled study in 408 patients 6 to 11 years of age, with moderate-to-severe asthma on a medium- or high- dose ICS and a second controller medication or high dose ICS alone. Patients were randomized to Dupixent (N=273) or matching placebo (N=135) every other week based on body weight ≤30 kg (100 mg Q2W) or >30 kg (200 mg Q2W), respectively. The efficacy was

evaluated in two primary analysis populations: (1) subjects with baseline blood eosinophil count of  $\geq 300$  cells/mL, and (2) subjects with baseline blood eosinophil count of  $\geq 150$  cells/mL or FeNO  $\geq 20$  ppb). The majority of patients with FeNO  $\geq 20$  ppb also had blood eosinophils levels of  $\geq 150$  cells/mL (184/203). The primary endpoint was the annualized rate of severe exacerbation events during the 52-week placebo-controlled period. A severe exacerbations were defined as deterioration of asthma requiring the use of systemic corticosteroids for at least 3 days or hospitalization or emergency room visit due to asthma that required systemic corticosteroids. The key secondary endpoint was the change from baseline in pre-bronchodilator FEV1 percent predicted at Week 12.

The effectiveness of Dupixent 300 mg Q4W in children 6 to 11 years of age with body weight 15 to  $< 60$  kg was extrapolated from efficacy of 100 mg Q2W and 200 mg Q2W in VOYAGE with support from population pharmacokinetic analyses (see CLINICAL PHARMACOLOGY).

The demographics and baseline characteristics for VOYAGE are provided in **Table 13**.

**Table 13 – Demographics and Baseline Characteristics of VOYAGE**

Parameter	ITT (N=408)
Mean age (years) (SD)	8.9 (1.6)
% Female	60.5
% White	88.2
Mean body weight (kg)	35.91
Mean exacerbations in previous year ( $\pm$ SD)	2.44 (2.18)
ICS dose (%) High	44.1
Pre-dose FEV1 (L) at baseline ( $\pm$ SD)	1.48 (0.41)
Mean percent predicted FEV1 (%) ( $\pm$ SD)	78.07 (14.72)
% Reversibility ( $\pm$ SD)	19.58 (20.76)
Mean ACQ-7-IA score ( $\pm$ SD)	2.13 (0.73)
Mean PAQLQ(S)-IA score ( $\pm$ SD)	4.91 (1.13)
Atopic Medical History % Overall (AD %, AR %)	92.4 (36.3, 81.9)
Median total IgE IU/mL ( $\pm$ SD)	792.28 (1093.46)
Mean FeNO ppb ( $\pm$ SD)	27.71 (23.84)
% patients with FeNO ppb $\geq$ 20	49.7
Mean baseline blood Eosinophil count ( $\pm$ SD) cells/mcL	500 (400)
% patients with baseline blood Eosinophil counts $\geq$ 150 cells/mcL $\geq$ 300 cells/mcL	81.1 63.5

ICS = inhaled corticosteroid; FEV1 = Forced expiratory volume in 1 second; ACQ-7-IA = Asthma Control Questionnaire-7 Interviewer Administered; PAQLQ(S)-IA = Paediatric Asthma Quality of Life Questionnaire with Standardised Activities–Interviewer Administered; AD = atopic dermatitis; AR= allergic rhinitis; FeNO = fraction of exhaled nitric oxide

#### **14.1.6 - Study demographics and trial design**

##### **Chronic Rhinosinusitis with Nasal Polyps**

The chronic rhinosinusitis with nasal polyposis (CRSwNP) development program included two randomized, double-blind, parallel-group, multicentre, placebo-controlled trials (SINUS-24 and SINUS-52) in 724 subjects aged 18 years and older receiving background intranasal corticosteroids (INCS). These trials included subjects with severe CRSwNP despite prior sino-nasal surgery, treatment with systemic corticosteroids in the past 2 years, or who were ineligible to receive systemic corticosteroids. Subjects with chronic rhinosinusitis without nasal polyposis were not included in these trials. Rescue treatment with systemic corticosteroids or surgery was allowed during the trials at the investigator's discretion. In SINUS-24, a total of 276 subjects were randomized to receive either 300 mg Dupixent (N=143) or placebo (N=133) every-other-week for 24 weeks. In SINUS-52, 448 subjects were randomized to receive either 300 mg Dupixent (N=150) every-other-week for 52 weeks, 300 mg Dupixent (N=145) every-other-week until week 24 followed by 300 mg Dupixent every 4 weeks until week 52, or placebo (N=153). All subjects had evidence of sinus opacification on the Lund MacKay (LMK) sinus CT scan and 73% to 90% of subjects had opacification of all sinuses. Subjects were stratified based on their histories of prior surgery and co-morbid asthma/nonsteroidal anti-inflammatory drug exacerbated respiratory disease (NSAID-ERD). A total of 63% of subjects reported previous sinus surgery, with a mean number of 2.0 prior surgeries, 74% used systemic corticosteroids in the previous 2 years with a mean number of 1.6 systemic corticosteroid courses in the previous 2 years, 59% had co-morbid asthma, and 28% had NSAID-ERD.

The co-primary efficacy endpoints were change from baseline to week 24 in bilateral endoscopic nasal polyps score (NPS; 0-8 scale) as graded by central blinded readers, and change from baseline to week 24 in nasal congestion/obstruction score averaged over 28 days (NC; 0-3 scale), as determined by subjects using a daily diary. For NPS, polyps on each side of the nose were graded on a categorical scale (0=no polyps; 1=small polyps in the middle meatus not reaching below the inferior border of the middle turbinate; 2=polyps reaching below the lower border of the middle turbinate; 3=large polyps reaching the lower border of the inferior turbinate or polyps medial to the middle turbinate; 4=large polyps causing complete obstruction of the inferior nasal cavity). The total score was the sum of the right and left scores. NC was rated daily by the subjects on a 0 to 3 categorical intensity scale (0=no symptoms; 1=mild symptoms; 2=moderate symptoms; 3=severe symptoms).

In both trials, key secondary endpoints at week 24 included change from baseline in: LMK sinus CT scan score, University of Pennsylvania smell identification test (UPSIT), daily loss of smell, and 22-item sino-nasal outcome test (SNOT-22). The LMK sinus CT scan score evaluated the opacification of each sinus using a 0 to 2 scale (0=normal; 1=partial opacification; 2=total opacification) deriving a maximum score of 12 per side and a total maximum score of 24 (higher scores indicate more opacification). Olfactory function was assessed by UPSIT, which is a 40-odorant test (score range 0-40) used to distinguish subjects (mild [score of 31-34], moderate [score of 26-30], severe microsmia [score of 19-25]) or anosmia [score of 0-18]). Loss of smell was scored reflectively by the patient every morning on a 0-3 scale (0=no symptoms, 1=mild symptoms, 2=moderate symptoms, 3=severe symptoms). SNOT-22 includes 22 items assessing symptoms and symptom impact associated with CRSwNP with each item scored from 0 (no problem) to 5 (problem as bad as it can be) with a global score ranging from 0 to 110; SNOT-22 had a 2 week recall period. In the pool of the two trials, the reduction in the proportion of subjects requiring rescue treatment with systemic corticosteroid and/or sino-nasal surgery was evaluated.

Demographics and baseline characteristics of these 2 trials are provided in **Table 14**.



**Table 14 – Demographics and Baseline Characteristics of CRSwNP Trials**

Parameter	SINUS-24 (N=276)	SINUS-52 (N=448)
Mean age (years) (SD)	50.49 (13.39)	51.95 (12.45)
% Male	57.2	62.3
Mean CRSwNP duration (years)(SD)	11.11 (9.16)	10.94 (9.63)
Subjects with ≥ 1 prior surgery (%)	71.7	58.3
Subjects with systemic corticosteroid use in the previous 2 years (%)	64.9	80.1
Mean Bilateral endoscopic NPS <sup>a</sup> (SD), range 0–8	5.75 (1.28)	6.10 (1.21)
Mean Nasal congestion (NC) score <sup>a</sup> (SD) range 0–3	2.35 (0.57)	2.43 (0.59)
Mean LMK sinus CT total score <sup>a</sup> (SD), range 0–24	19.03 (4.44)	17.96 (3.76)
Mean Smell test (UPSIT) score <sup>a</sup> (SD), range 0–40	14.56 (8.48)	13.61 (8.02)
Mean Sense of smell loss score <sup>a</sup> (AM), (SD) range 0–3	2.71 (0.54)	2.75 (0.52)
Mean SNOT-22 total score <sup>a</sup> (SD), range 0–110	49.40 (20.20)	51.86 (20.90)
Mean blood eosinophils (cells/mcL)(SD)	437 (333)	431 (353)
Mean total IgE IU/mL (SD)	201.37 (281.50)	211.79 (257.38)
Atopic (type 2 inflammatory disease) Medical History % Overall	75.4%	82.4%
Asthma (%)	58.3	59.6
NSAID-ERD (%)	30.4	26.8

<sup>a</sup>Higher scores indicate greater disease severity except UPSIT where higher scores indicate lower disease severity; SD=standard deviation; AM = morning; NPS = nasal polyps score; LMK = Lund Mackay; UPSIT = University of Pennsylvania smell identification test; SNOT-22 = 22-item sino-nasal outcome test; NSAID-ERD= asthma/nonsteroidal anti-inflammatory drug exacerbated respiratory disease.

#### **14.1.7 – Eosinophilic Esophagitis**

The eosinophilic esophagitis (EoE) development program included a three-part protocol (TREET) consisting of two separately randomized, double-blind, parallel-group, multicentre, placebo-controlled, 24-week treatment studies (TREET Part A and TREET Part B) in adult and adolescent subjects (12 to 17 years of age) weighing at least 40 kg. In both parts, subjects were required to have ≥15 intraepithelial eosinophils per high-power field (eos/hpf) following an at least 8-week course of a high-dose proton pump inhibitor (PPI) either prior to or during the screening period and a Dysphagia Symptom Questionnaire (DSQ) score ≥10 on a scale of 0 to 84. Subjects completing the 24 weeks double-blind treatment period in Parts A or B were provided an option to enroll in a 28-week active treatment extension study (TREET Part C).

In Part A, a total of 81 subjects (61 adults and 20 adolescents) were randomized (1:1) to receive either 300 mg Dupixent every week or placebo. In Part B, a total of 159 subjects (107 adults and 52 adolescents) were randomized (1:1) to receive either 300 mg Dupixent every week or placebo. Rescue with systemic and/or swallowed topical corticosteroids or emergency esophageal dilation was allowed during the study at the investigator’s discretion.

The co-primary efficacy endpoints in Parts A and B were (i) the proportion of subjects achieving a peak esophageal intraepithelial eosinophil count of ≤6 eos/hpf (i.e., histological remission) at Week 24; and (ii) the absolute change in the patient-reported DSQ score from baseline to Week 24. EoE-EREFS, which assesses characteristic inflammatory and remodeling endoscopic features of EoE, including Edema, Rings, Exudates, Furrows, and Stenosis, was a secondary endpoint.

The demographics and baseline characteristics of TREET Parts A and B are provided in **Table 15**.

**Table 15 - Demographics and Baseline Characteristics (TREET Parts A and B)**

Parameter	TREET Part A (N=81)	TREET Part B (N=159)
Age (years), mean (SD)	31.5 (14.3)	28.3 (13.1)
% Male	60.5	67.9
% White	96.3	89.9
Weight (kg), mean (SD)	77.8 (21.0)	77.3 (20.4)
BMI (kg/m <sup>2</sup> ), mean (SD)	26.1 (6.3)	25.9 (6.4)
Duration of EoE (yr), mean (SD)	5.01 (4.3)	5.39 (4.6)
Prior swallowed topical steroid use (%)	74.1	69.8
Prior esophageal dilations (%)	43.2	37.1
PPI use at randomization (%)	67.9	73.6
Food elimination diet at screening (%)	40.7	37.7
DSQ score (0-84 <sup>a</sup> ), mean (SD)	33.6 (12.4)	37.2 (10.7)
Peak esophageal intraepithelial eosinophil count of 3 regions, mean (SD)	89.3 (48.3)	86.8 (44.0)
Mean esophageal intraepithelial eosinophil count of 3 regions, mean (SD)	64.3 (37.6)	59.7 (30.9)
EREFS total Score [0-18 <sup>a</sup> ], mean (SD)	6.3 (2.8)	7.0 (3.2)

<sup>a</sup>Higher scores indicate greater disease severity

SD = standard deviation

#### **14.1.8 - Study demographics and trial design**

##### **Prurigo Nodularis**

The prurigo nodularis (PN) development program included two 24-week randomized, double-blind, placebo-controlled, multicenter, parallel-group studies (PRIME and PRIME2) in 311 patients 18 years of age and older with severe pruritus (WI-NRS  $\geq 7$  on a scale of 0 to 10) and greater than or equal to 20 nodular lesions whose disease was not adequately controlled with topical prescription therapies or when those therapies were not advisable. PRIME and PRIME2 assessed the effect of DUPIXENT on itch improvement as well as its effect on PN lesions.

In these two studies, patients received either subcutaneous DUPIXENT 600 mg (two 300 mg injections) on day 1, followed by 300 mg once every other week (Q2W) for 24 weeks, or matching placebo.

Patients on a stable regimen of low to medium potency TCS or TCI could continue their concomitant topical steroid application. Participants who were on a stable regimen of high potency or super potent steroids were asked to decrease to medium potency TCS at the screening. At baseline, a total of 182 (58.5%) participants reported stable use of TCS/TCI.

**Table 16- Demographics and Baseline Characteristics (PRIME and PRIME2)**

<b>Parameter</b>	<b>PRIME (N=151)</b>	<b>PRIME2 (N=160)</b>
Mean age (years) (SD)	50.1 (16.6)	48.8 (15.6)
% Female	66.2	64.4
Race:		
% White	53.0	60.0
% Black	7.3	5.0
% Asian	35.8	32.5
Median weight (kg)	71.0	72.2
Mean WI-NRS (SD)	8.5 (1.0)	8.5 (1.0)
IGA PNS:		
% Moderate (20-100 Nodules)	71.3	61.6
% Severe (>100 nodules)	28.7	38.4
% Prior Topical therapy use	100	99.3
% Prior systemic corticosteroid use	15.0	19.9
% Prior non-steroidal systemic immunosuppressant use	23.8	17.2
% Prior Gabapentin use	4.6	0.6
% stable TCS/TCI use at baseline	60.9	56.3
% Antidepressant use at baseline	11.9	9.4
% History of Atopy (medical history of AD, allergic rhinitis/rhinoconjunctivitis, asthma or food allergy)	40.4	46.3

The WI-NRS is comprised of a single item, rated on a scale from 0 (“no itch”) to 10 (“worst imaginable itch”). Participants were asked to rate the intensity of their worst pruritus (itch) over the past 24 hours using this scale. The IGA PN-S is a scale that measures the approximate number of nodules using a 5-point scale from 0 (clear) to 4 (severe).

The primary efficacy endpoint was the proportion of patients with improvement (reduction) in WI-NRS by  $\geq 4$  points. Key secondary endpoints included the proportion of participants with IGA PN-S 0 or 1 (the equivalent of 0-5 nodules) and the proportion of subjects who achieved a response in both WI-NRS and IGA PN-S per the criteria described above.

## **14.2 Study Results**

### **14.2.1 Study results: Atopic Dermatitis in adults**

In SOLO 1, SOLO 2 and CHRONOS, from baseline to week 16, a clinically and significantly greater proportion of subjects randomized to Dupixent achieved an IGA 0 or 1 response, EASI-75, and/or an improvement of  $>4$  points on the pruritus NRS compared to placebo (see **Table 16**).

**Table 16 – Efficacy Results of Dupixent Monotherapy and concomitant TCS in adults at Week 16 (FAS)**

	SOLO 1 (FAS) <sup>a</sup>		SOLO 2 (FAS) <sup>a</sup>		CHRONOS (FAS) <sup>f</sup>	
	Placebo	Dupixent 300 mg Q2W	Placebo	Dupixent 300 mg Q2W	Placebo + TCS	Dupixent 300 mg Q2W+TCS
<b>Subjects randomized</b>	224	224	236	233	315	106
IGA 0 or 1 <sup>b</sup> , % responders <sup>c</sup>	10.3 %	37.9 % <sup>e</sup>	8.5 %	36.1 % <sup>e</sup>	12.4 %	38.7 %
EASI-75, % responders <sup>c</sup>	14.7 %	51.3 % <sup>e</sup>	11.9 %	44.2 % <sup>e</sup>	23.2 %	68.9 % <sup>e</sup>
EASI-90, % responders <sup>c</sup>	7.6 %	35.7 % <sup>e</sup>	7.2 % <sup>e</sup>	30.0 %	11.1 % <sup>e</sup>	39.6 % <sup>e</sup>
<b>Number of subjects with baseline pruritus NRS score <math>\geq 4</math></b>	212	213	221	225	299	102
Pruritus NRS ( $\geq 4$ -point improvement), % responders <sup>c, d</sup>	12.3 %	40.8 % <sup>e</sup>	9.5%	36.0 % <sup>e</sup>	19.7 %	58.8 % <sup>e</sup>

IGA = Investigator’s Global Assessment scale; EASI = Eczema Area and Severity Index; NRS = pruritus Numerical Rating Scale; Q2W = every other week

<sup>a</sup> Full analysis set (FAS) includes all subjects randomized.

<sup>b</sup> Responder was defined as a subjects with IGA 0 or 1 (“clear” or “almost clear”) with a reduction of  $\geq 2$  points on a 0-4 IGA scale.

<sup>c</sup> Subjects who received rescue treatment or with missing data were considered as non-responders.

<sup>d</sup> a significantly greater proportion of subjects on Dupixent had improvement in pruritus NRS of  $\geq 4$  points compared to placebo at week 2 ( $p < 0.01$ )

<sup>e</sup> p-value  $< 0.0001$

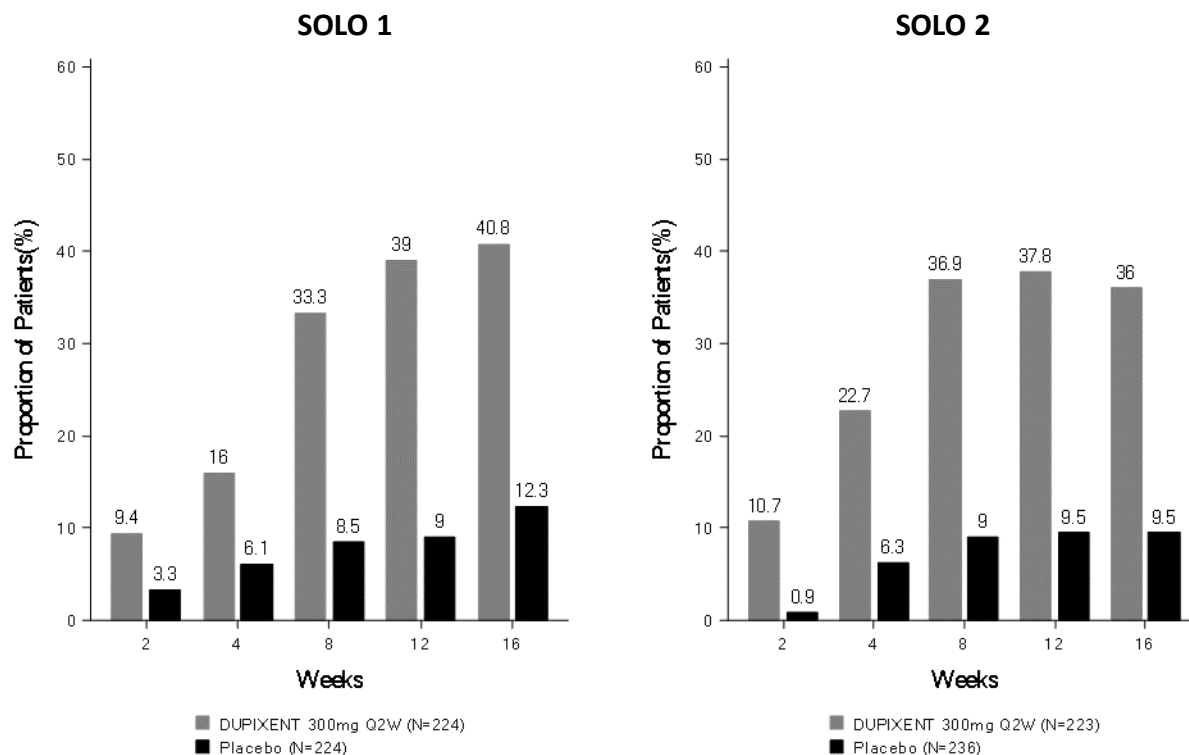
<sup>f</sup> All subjects were on background TCS therapy and subjects were permitted to use topical calcineurin inhibitors.

The primary and key secondary efficacy endpoints (categorical) were analyzed using the Cochran-Mantel-Haenszel test. To control the total type 1 error rate at 0.05, each dose regimen was tested at  $\alpha = 0.025$  and a hierarchical testing procedure was used for the multiple endpoints within each dose regimen. Results are based on patient considered non-responder after rescue treatment use.

A significantly greater proportion of subjects randomized to Dupixent achieved a rapid improvement in the pruritus NRS compared to placebo (defined as  $> 4$ -point improvement as early as week 2;  $p < 0.01$ )

and the proportion of subjects responding on the pruritus NRS continued to increase through the treatment period (see **Figure 1**).

**Figure 1 – Proportion of patients with  $\geq 4$ -point Improvement on the Pruritus NRS in SOLO 1<sup>a</sup> and SOLO 2<sup>a</sup> (FAS)<sup>b</sup>**



<sup>a</sup> In the primary analyses of the efficacy endpoints, subjects who received rescue treatment or with missing data were considered non-responders.

<sup>b</sup> Full Analysis Set (FAS) includes all subjects randomized.

Treatment effects in subgroups (weight, age, gender, race, and background treatment, including immunosuppressants) in SOLO 1 and SOLO 2 were in general consistent with the results in the overall study population.

In studies SOLO 1, SOLO 2, and CHRONOS, a third randomized treatment arm of Dupixent 300 mg QW did not demonstrate additional treatment benefit over Dupixent 300 mg Q2W.

### **52-Week Concomitant TCS Study (CHRONOS)**

In the CHRONOS trial, of the 421 subjects, 353 had been on study for 52 weeks at the time of data analysis. Of these 353 subjects, responders at Week 52 represent a mixture of subjects who maintained their efficacy from Week 16 (e.g., 53% of Dupixent IGA 0 or 1 responders at Week 16 remained responders at Week 52) and subjects who were non-responders at Week 16 who later responded to treatment. Results of supportive analyses of the 353 subjects in the CHRONOS trial are presented in **Table 17**.

**Table 17 – The Percentage of Responders in Clinical Trial CHRONOS by Treatment Arm and Responder Status at Week 16 and Week 52**

	Dupixent 300 mg Q2W + TCS	Placebo + TCS
Number of Subjects <sup>a</sup>	89	264
Responder <sup>b,c</sup> at Week 16 and 52	22%	7%
Responder at Week 16 but Non-responder at Week 52	20%	7%
Non-responder at Week 16 and Responder at Week 52	13%	6%
Non-responder at Week 16 and 52	44%	80%
Overall Responder <sup>b,c</sup> Rate at Week 52	36%	13%

<sup>a</sup> In CHRONOS, of the 421 randomized and treated subjects, 68 subjects (16%) had not been on study for 52 weeks at the time of data analysis.

<sup>b</sup> Responder was defined as a subject with IGA 0 or 1 (“clear” or “almost clear”) with a reduction of  $\geq 2$  points on a 0-4 IGA scale.

<sup>c</sup> Subjects who received rescue treatment or with missing data were considered as non-responders.

### **Additional Secondary Endpoints**

Patient reported outcomes in both monotherapy studies (SOLO1 and SOLO2) and in the Dupixent +TCS study (CHRONOS) were consistent with significant improvements observed in the physician reported outcomes.

A larger proportion of subjects treated with Dupixent had  $\geq 4$  points improvement (corresponding to minimal clinically important difference) in POEM and DLQI in SOLO1, SOLO2, and CHRONOS studies compared to placebo.

In SOLO 1, the proportion of Dupixent-treated responders for POEM and DLQI was 67.6% and 64.1%, respectively, compared to 26.9% and 30.5% for placebo at week 16.

In SOLO 2, the proportion of Dupixent-treated responders for POEM and DLQI was 71.7% and 73.1%, respectively, compared to 24.4% and 27.6% for placebo at week 16.

In CHRONOS, the proportion of Dupixent-treated responders for POEM and DLQI was 76.4% and 80.0%, respectively, compared to 26.1% and 30.3% for placebo at week 52.

### **Atopic Dermatitis in Adolescents**

Dupixent monotherapy in adolescent subjects was evaluated in a multicenter, randomized, double-blind, placebo-controlled trial, AD-1526, in 251 adolescent subjects 12 to 17 years of age with moderate-to-severe AD defined by IGA score  $\geq 3$  in the overall assessment of AD lesions on a severity scale of 0 to 4, an EASI score  $\geq 16$  on a scale of 0 to 72, and a minimum BSA involvement of  $\geq 10\%$ . Eligible subjects enrolled into this trial had previous inadequate response to topical medication.

Subjects in the Dupixent group received an initial dose of 400 mg at Week 0, followed by 200 mg Q2W for subjects with baseline weight of  $<60$  kg or an initial dose of 600 mg at Week 0, followed by 300 mg Q2W for subjects with baseline weight of  $\geq 60$  kg for 16 weeks. Dupixent was administered by subcutaneous injection. If needed to control intolerable symptoms, subjects were permitted to receive rescue treatment at the discretion of the investigator. Subjects who received rescue treatment were



considered non-responders.

In the AD-1526 study, the mean age was 14.5 years, the median weight was 59.4 kg, 41% of subjects were female, 63% were White, 15% were Asian, and 12% were Black. At baseline 46% of subjects had an IGA score of 3 (moderate AD), 54% had an IGA score of 4 (severe AD), the mean BSA involvement was 57%, and 42% had received prior systemic immunosuppressants. Also, at baseline the mean EASI score was 36, and the weekly averaged peak pruritus NRS was 8 on a scale of 0-10. Overall, 92% of subjects had at least one co-morbid allergic condition; 66% had allergic rhinitis, 54% had asthma, and 61% had food allergies.

The co-primary endpoints were the proportion of subjects with IGA 0 (clear) or 1 (almost clear) with at least a 2-point improvement, and the proportion of subjects with EASI-75 (improvement of at least 75% in EASI), from baseline to Week 16. Other evaluated outcomes included the proportion of subjects with EASI-90 (improvement of at least 90% in EASI from baseline), reduction in itch as measured by the peak pruritus NRS and from baseline to Week 16. Additional secondary endpoints included mean change from baseline to week 16 in the POEM and CDLQI scores.

The efficacy results at Week 16 for AD-1526 Study are presented in **Table 18**

**Table 18 – Efficacy Results of Dupixent in the AD-1526 Study at Week 16 (FAS)<sup>a</sup>**

	Placebo N=85 <sup>a</sup>	Dupixent 200 mg (<60 kg) or 300 mg (≥60 kg) Q2W N=82 <sup>a</sup>
IGA 0 or 1 <sup>b,c</sup>	2%	24%
EASI-75 <sup>c</sup>	8%	42%
EASI-90 <sup>c</sup>	2%	23%
Pruritus NRS, LS mean % change from baseline (+/- SE)	-19% (4.1)	-48% (3.4)
Peak Pruritus NRS (≥4-point improvement) <sup>c</sup>	5%	37%

<sup>a</sup> Full Analysis Set (FAS) includes all subjects randomized.

<sup>b</sup> Responder was defined as a subject with IGA 0 or 1 (“clear” or “almost clear”) with a reduction of ≥2 points on a 0-4 IGA scale.

<sup>c</sup> Subjects who received rescue treatment or with missing data were considered as non-responders (59% and 21% in the placebo and Dupixent arms, respectively).

Patient reported outcomes CDLQI and POEM were consistent with significant improvements observed in the physician reported outcomes. The reductions in mean CDLQI and mean POEM scores from baseline to week 16 week were -8.5 (0.50) and -10.1 (0.76) for Dupixent and -5.1(0.62) and -3.8 (0.96) for placebo, respectively.

A larger percentage of subjects randomized to placebo needed rescue treatment (topical corticosteroids, systemic corticosteroids, or systemic non-steroidal immunosuppressants) as compared to the Dupixent group (59% and 21%, respectively).

A significantly greater proportion of subjects randomized to Dupixent achieved a rapid improvement in the pruritus NRS compared to placebo, (defined as >4-point improvement as early as Week 4; nominal p<0.001) and the proportion of subjects responding on the pruritus NRS continued to increase through the treatment period. The improvement in pruritus NRS occurred in conjunction with the improvement of objective signs of atopic dermatitis.

The long-term efficacy of Dupixent in adolescent patients with moderate-to-severe AD who had participated in previous clinical trials of Dupixent was assessed in an open-label extension trial (AD-1434). Efficacy data from this trial suggests that clinical benefit provided at Week 16 was sustained through Week 52.

#### **14.2.2 Study results: Atopic Dermatitis in pediatrics (6 to 11 years of age)**

Table 19 presents the results by baseline weight strata for the recommended dose regimens.

**Table 19 – Efficacy Results of Dupixent with Concomitant TCS in AD-1652 at Week 16 (FAS)<sup>a</sup>**

	Dupixent 300 mg Q4W <sup>d</sup> + TCS	Placebo Q4W+TCS	Dupixent 200 mg Q2W <sup>e</sup> + TCS	Placebo Q2W+ TCS
	(N=61)	(N=61)	(N=59)	(N=62)
	<30 kg	<30 kg	≥30 kg	≥30 kg
IGA 0 or 1 <sup>b</sup> , % responders <sup>c</sup>	29.5%	13.1%	39.0%	9.7%
EASI-75, % responders <sup>c</sup>	75.4%	27.9%	74.6%	25.8%
EASI-90, % responders <sup>c</sup>	45.9%	6.6%	35.6%	8.1%
Pruritus NRS (≥4-point improvement), % responders <sup>c</sup>	54.1%	11.7%	61.4%	12.9%

<sup>a</sup>Full Analysis Set (FAS) includes all randomized subjects.

<sup>b</sup>Responder was defined as a subject with an IGA 0 or 1 (“clear” or “almost clear”).

<sup>c</sup>Subjects who received rescue treatment or who had missing data were classified as non-responders.

<sup>d</sup>The worst itch NRS was an adaptation of the peak pruritus NRS instrument used in adult trials in which the wording was simplified to make it age appropriate.

<sup>d</sup>Subjects received an initial dose of 600 mg of dupilumab.

<sup>e</sup>Subjects received an initial dose of 200 mg (baseline weight <30 kg) or 400 mg (baseline weight ≥30 kg) of dupilumab.

A greater proportion of subjects randomized to Dupixent + TCS achieved an improvement in the peak pruritus NRS compared to placebo + TCS (defined as ≥4-point improvement at week 4).

In subjects receiving Dupixent, favorable changes were observed with respect to patient-reported symptoms, the impact of AD on sleep, and health-related quality of life as measured by POEM, and CDLQI scores at Week 16 compared to placebo.

The changes in mean CDLQI score from baseline to week 16 were -11.5 and -7.2 for Dupixent 300 mg Q4W (< 30 kg) and placebo, respectively, and -9.8 and -5.6 for Dupixent 200 mg Q2W (≥ 30 kg) and placebo, respectively. The changes in mean POEM score from baseline to week 16 were -14.0 and -5.9 for Dupixent 300 mg Q4W (< 30 kg) and placebo, respectively, and -13.6 and -4.7 for Dupixent 200 mg Q2W (≥ 30 kg) and placebo, respectively.

In pediatric patients with atopic dermatitis who had participated in the previous Dupixent clinical trials and enrolled in the open-label extension study (AD-1434), the effect observed at Week 16 was consistent at Week 52.

### **14.2.3 - Study results: Atopic dermatitis in pediatrics (6 months to 5 years of age)**

The efficacy results at Week 16 for AD-1539 are presented in **Table 20**.

**Table 20 - Efficacy Results of Dupixent with Concomitant TCS in AD-1539 at Week 16 (FAS)<sup>a</sup>**

	<b>Dupixent + TCS 200 mg (5 to &lt;15kg) or 300 mg (15 to &lt;30 kg) Q4W<sup>d</sup> (N=83)</b>	<b>Placebo + TCS (N=79)</b>	<b>Difference vs. Placebo (95 % CI)</b>
IGA 0 or 1 <sup>b,c</sup>	27.7%	3.9%	23.8% (13.3%, 34.4%)
EASI-75 <sup>c</sup>	53.0%	10.7%	42.3% (29.5%, 55.2%)
EASI-90 <sup>c</sup>	25.3%	2.8%	22.5% (12.4%, 32.6%)
Worst Scratch/Itch NRS (≥4-point improvement) <sup>c</sup>	48.1%	8.9%	39.2% (26.2%, 52.3%)

<sup>a</sup> Full Analysis Set (FAS) includes all patients randomized.

<sup>b</sup> Responder was defined as a patient with an IGA 0 or 1 (“clear” or “almost clear”).

<sup>c</sup> Patients who received rescue treatment (62% and 19% in the placebo and Dupixent arms, respectively) or with missing data were considered as non-responders.

<sup>d</sup> At Day 1, patients received 200 mg (5 to <15kg) or 300 mg (15 to <30 kg) of Dupixent.

In subjects receiving Dupixent, statistically significant differences compared to placebo were observed with respect to patient-reported symptoms and health-related quality of life as measured by POEM, CDLQI (in 85 patients 4-5 years old) / IDQOL (in 77 patients 6 months to 3 years old) score, skin pain NRS, and sleep quality NRS at Week 16. In the ITT population, the magnitude of LS mean change in CDLQI and IDQOL scores from baseline to week 16 observed was greater in the Dupixent + TCS (-10.0 and -10.9) group compared to the placebo + TCS group (-2.5 and -2.0).

The changes in mean POEM score from baseline to week 16 were -12.9 and -3.8 for Dupixent + TCS and placebo, respectively.

### **14.2.4 Study results: Asthma in adults and adolescents (aged 12 years and older)**

#### **Exacerbations**

Results of annualized rate of severe exacerbation event for DRI12544 and QUEST are presented in **Table 21**. In the overall population, in QUEST, the rate of severe exacerbations was 0.46 and 0.52 for Dupixent 200 mg Q2W and 300 mg Q2W, respectively, compared to matched placebo rates of 0.87 and 0.97. The rate ratio of severe exacerbations compared to placebo was 0.52 (95% CI: 0.41, 0.66) and 0.54 (95% CI: 0.43, 0.68) for Dupixent 200 mg Q2W and 300 mg Q2W, respectively.

**Table 21 – Rate of Severe Exacerbations in DRI12544 and QUEST**

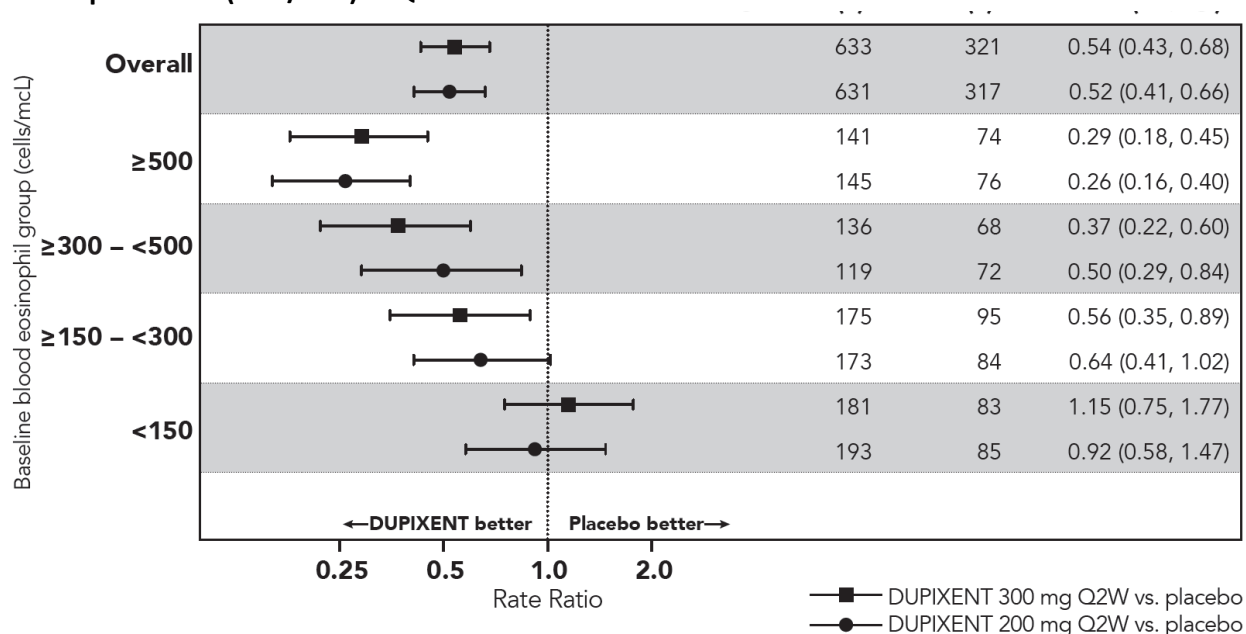
Study	Treatment	Baseline Blood EOS $\geq 300$ cells/mcl		
		N	Rate (95% CI)	Rate Ratio (95% CI)
DRI12544	Dupixent 200 mg Q2W	65	0.30 (0.13, 0.68)	0.29 (0.11, 0.76)
	Dupixent 300 mg Q2W	64	0.20 (0.08, 0.52)	0.19 (0.07, 0.56)
	Placebo	68	1.04 (0.57, 1.90)	
QUEST	Dupixent 200 mg Q2W	264	0.37 (0.29, 0.48)	0.34 (0.24, 0.48)
	Placebo	148	1.08 (0.85, 1.38)	
	Dupixent 300 mg Q2W	277	0.40 (0.32, 0.51)	0.33 <sup>a</sup> (0.23, 0.45)
	Placebo	142	1.24 (0.97, 1.57)	

<sup>a</sup>p-value <0.0001

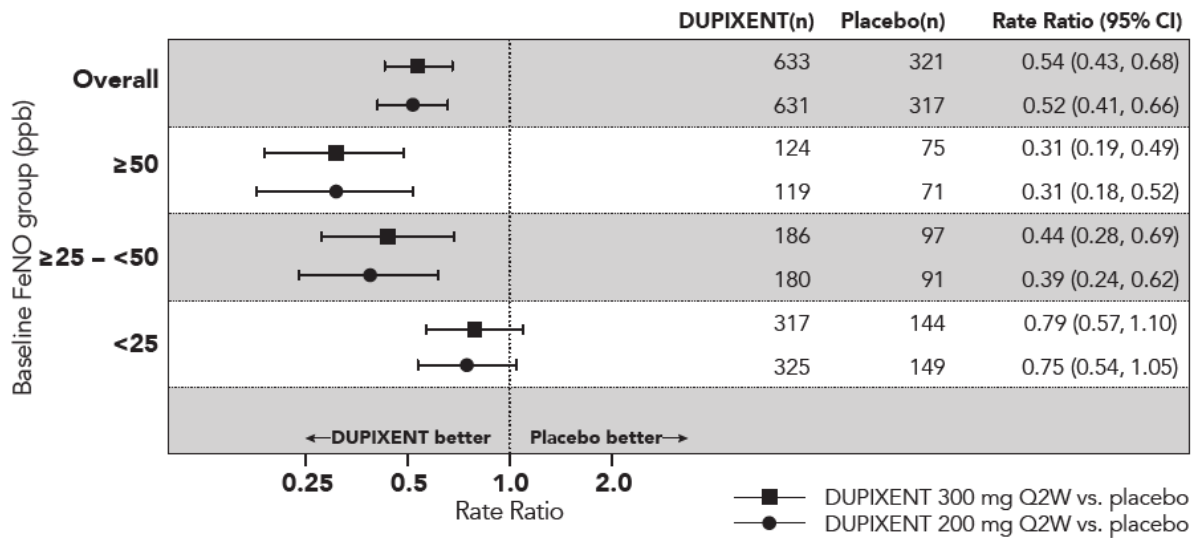
For QUEST study, a hierarchical testing procedure was used to strongly control the overall Type I error rate. Adjusted annualized severe exacerbation event rate is derived using negative binomial model with the total number of events as the response variable, with treatment, age, region, baseline eosinophil stratum, baseline ICS dose level and number of severe exacerbation events within 1 year prior to the study as covariates, and log-transformed standardized observation duration as an offset variable.

Results of annualized rate of severe exacerbation event based on baseline blood eosinophil counts are presented in Figure 2. Results of annualized rate of severe exacerbation event based on an exploratory analysis by baseline FeNO levels are presented in Figure 3.

**Figure 2 – Relative Risk in Annualized Event Rate of Severe Exacerbations Across Baseline Blood Eosinophil Count (cells/mcl) in QUEST**



**Figure 3 – Relative Risk in Annualized Event Rate of Severe Exacerbations across Baseline FeNO group (ppb) in QUEST**



In QUEST, the estimated rate ratio of exacerbations leading to hospitalizations and/or emergency room visits versus placebo was 0.53 (95% CI: 0.28, 1.03) and 0.74 (95% CI: 0.32, 1.70) with Dupixent 200 mg or 300 mg Q2W, respectively.

## Lung Function

Results of change from baseline in pre-bronchodilator FEV<sub>1</sub> at Week 12 for DRI12544 and QUEST are presented in **Table 22**. In the overall population in QUEST, the FEV<sub>1</sub> LS mean change from baseline was 0.32 L (21%) and 0.34 L (23%) for Dupixent 200 mg Q2W and 300 mg Q2W, respectively, compared to matched placebo means of 0.18 L (12%) and 0.21 L (14%). The LS mean treatment difference versus placebo was 0.14 L (95% CI: 0.08, 0.19) and 0.13 L (95% CI: 0.08, 0.18) for Dupixent 200 mg Q2W and 300 mg Q2W, respectively.

**Table 22 – Mean Change from Baseline and vs Placebo in Pre-Bronchodilator FEV<sub>1</sub> at Week 12 in DRI12544 and QUEST**

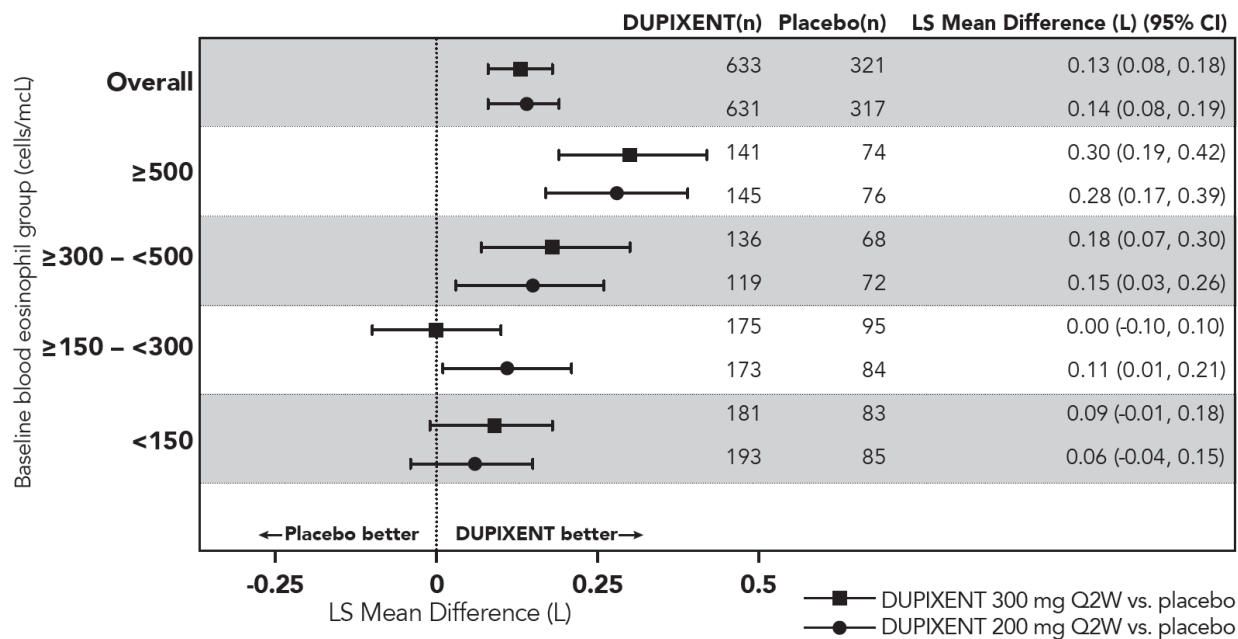
Study	Treatment	Baseline Blood EOS ≥300 cells/mcl		
		N	LS Mean Change from baseline L (%)	LS Mean Difference vs. placebo (95% CI)
DRI12544	Dupixent 200 mg Q2W	65	0.43 (25.9)	0.26 (0.11, 0.40)
	Dupixent 300 mg Q2W	64	0.39 (25.8)	0.21 (0.06, 0.36)
	Placebo	68	0.18 (10.2)	
QUEST	Dupixent 200 mg Q2W	264	0.43 (29.0)	0.21 (0.13, 0.29)
	Placebo	148	0.21 (15.6)	
	Dupixent 300 mg Q2W	277	0.47 (32.5)	0.24 <sup>a</sup> (0.16, 0.32)
	Placebo	142	0.22 (14.4)	

<sup>a</sup> p-value <0.0001

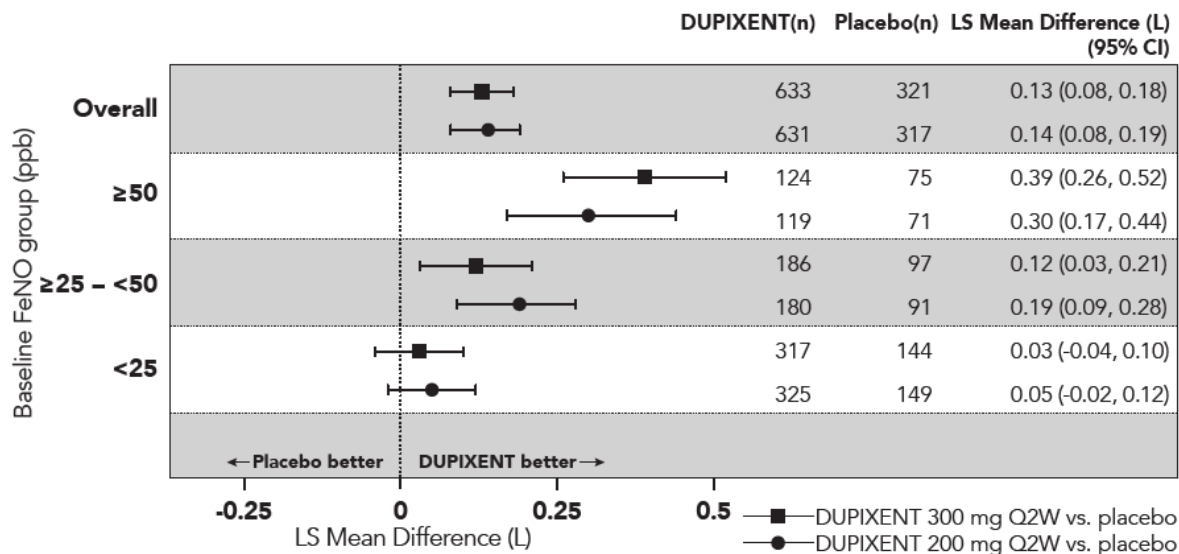
For QUEST study, a hierarchical testing procedure was used to strongly control the overall Type I error rate. LS mean and LS mean difference were derived from MMRM model with change from baseline in pre-bronchodilator FEV<sub>1</sub> values up to Week 12 as response variable, and treatment, age, sex, baseline height, region, baseline eosinophil stratum, baseline ICS dose level, visit, treatment by-visit interaction, baseline pre-bronchodilator FEV<sub>1</sub> value and baseline-by-visit interaction as covariates.

Results of change from baseline in pre-bronchodilator FEV<sub>1</sub> at Week 12 based on baseline blood eosinophil counts are presented in Figure 4. Results of change from baseline in pre-bronchodilator FEV<sub>1</sub> at Week 12 based on an exploratory analysis by baseline FeNO levels are presented in **Figure 5**.

**Figure 4 – LS Mean Difference in Change from Baseline vs Placebo to Week 12 in Pre-Bronchodilator FEV<sub>1</sub> across Baseline Blood Eosinophil Counts (cells/mcL) in QUEST**

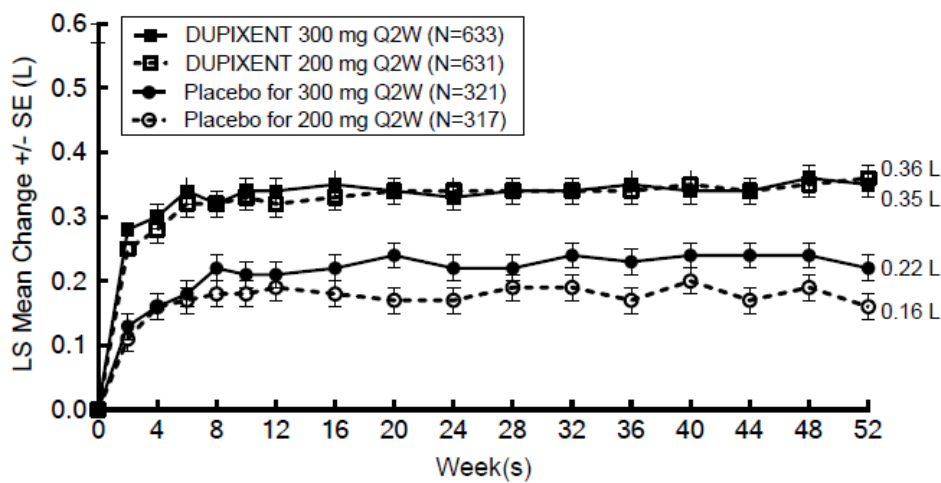


**Figure 5 – LS Mean Difference in Change from Baseline vs Placebo to Week 12 in Pre-Bronchodilator FEV<sub>1</sub> across Baseline FeNO (ppb) in QUEST**



The change in FEV<sub>1</sub> over 52 weeks in QUEST overall population is presented in **Figure 6**.

**Figure 6 – Mean Change from Baseline in Pre-Bronchodilator FEV1 (L) Over Time in QUEST (ITT Population)**



#### Asthma Symptoms and Quality of Life

ACQ-5 and AQLQ(S) were assessed in QUEST at 52 weeks. A responder rate was defined as an improvement in score of at least 0.5 units for ACQ-5 (scale range 0-6) and AQLQ(S) (scale range 1-7), respectively.

In QUEST, in the overall population, the ACQ-5 responder rate in subjects receiving Dupixent 200 mg and 300 mg Q2W was 69% and 69%, respectively, and 62% and 63% in subjects receiving placebo. The AQLQ(S) responder rate in subjects receiving Dupixent 200 mg and 300 mg Q2W was 62% and 62%, respectively, and 54% and 57% in subjects receiving placebo. The ACQ-5 and AQLQ(S) responder rates in subjects with baseline blood eosinophils  $\geq 300$  cells/mcL were consistent with the overall population.

#### Oral Corticosteroid Reduction (VENTURE)

The mean percent reduction in daily OCS dose from baseline at week 24 in subjects receiving the recommended dose of Dupixent was 70.1% (median 100 %) and placebo was 41.9% (median 50 %). Reductions of 50% or higher in the OCS dose were observed in 82 (79.6%) subjects receiving Dupixent and 57 (53.3%) of subjects receiving placebo. The proportion of subjects with a mean final OCS dose less than 5 mg at Weeks 24 was 69% for Dupixent and 33% for placebo. Only subjects with a daily baseline OCS dose of 30 mg or less were eligible to achieve a 100% reduction in OCS dose during the study. Of those subjects, 52.8% (54 of 103) receiving Dupixent and 29.2% (31 of 106) receiving placebo achieved a 100% reduction in OCS dose.

The annualized rate of severe exacerbation event was 0.65 in subjects receiving Dupixent and 1.60 in subjects receiving placebo; an exacerbation was defined as an increase in OCS dose for  $\geq 3$  days. The LS mean change from baseline in pre-bronchodilator FEV1 at week 24 was 0.22L in subjects receiving Dupixent and 0.01L in subjects receiving placebo. Changes in ACQ-5 and AQLQ(S) were consistent with those observed in QUEST.

#### Long-term extension trial (TRAVERSE)

The long-term safety of Dupixent in 2193 adults and 89 adolescents (aged 12 to 17 years) with moderate-to-severe asthma, including 185 adults with oral corticosteroid-dependent asthma, who had participated in previous clinical trials of Dupixent, was assessed in the open-label extension study



(TRAVERSE). Efficacy was measured as a secondary endpoint up to 96 weeks, and the results were consistent with results observed in the pivotal studies. The adults with oral corticosteroid dependent asthma had efficacy results that were consistent with the pivotal studies up to 96 weeks, despite decrease or discontinuation of oral corticosteroid dose.

#### **14.2.5 Study results : Asthma in pediatrics 6 to 11 years of age**

##### **VOYAGE**

Results of annualized rate of severe asthma exacerbation events during the 52-week treatment period compared to placebo and results in change from baseline in percent predicted pre-bronchodilator FEV1 at Week 12 in the population with baseline blood eosinophils  $\geq 150$  cells/mcl or FeNO  $\geq 20$  ppb are presented in Table 17. In this population, the LS mean change from baseline in pre-bronchodilator FEV1 at Week 12 was 0.22 L in the Dupixent group and 0.12 L in the placebo group; at Week 52 the treatment effect was consistent with results observed at Week 12.

**Table 23 – Rate of Severe Exacerbations and Mean Change from Baseline and vs Placebo in percent-predicted pre-bronchodilator FEV1 in VOYAGE**

Treatment	EOS $\geq 150$ cells/mcl or FeNO $\geq 20$ ppb		
Annualized severe exacerbations rate over 52 weeks			
	N	Rate (95% CI)	Rate Ratio (95% CI)
Dupixent 100 mg Q2W (<30 kg)/ 200 mg Q2W ( $\geq 30$ kg)	236	0.305 (0.223, 0.416)	0.407 (0.274, 0.605)
Placebo	114	0.748 (0.542, 1.034)	
Mean Change from Baseline in percent predicted FEV <sub>1</sub> at Week 12			
	N	LS mean $\Delta$ from baseline in percent predicted FEV <sub>1</sub>	LS mean difference vs. placebo (95% CI)
Dupixent 100 mg Q2W (<30 kg)/ 200 mg Q2W ( $\geq 30$ kg)	229	10.53	5.21 (2.14, 8.27)
Placebo	110	5.32	

A hierarchical testing procedure was used to strongly control the overall Type I error rate. Adjusted annualized severe exacerbation event rate is derived using negative binomial model with the total number of events as the response variable, with treatment, age, baseline weight group, region, baseline eosinophil level, baseline FeNO level, baseline ICS dose level and number of severe exacerbation events within 1 year prior to the study as covariates, and log-transformed standardized observation duration as an offset variable. LS mean and LS mean difference were derived from MMRM model with change from baseline in percent predicted pre-bronchodilator FEV1 values up to Week 12 as response variable, and treatment, baseline weight group, region, ethnicity, baseline

eosinophil level, baseline FeNO level, baseline ICS dose level, visit, treatment by-visit interaction, baseline percent predicted pre-bronchodilator FEV1 value and baseline-by-visit interaction as covariates.

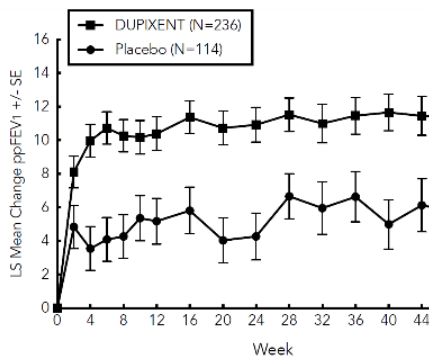
Results of the primary and key secondary endpoint in the population with baseline blood eosinophils  $\geq 300$  cells/mcl were consistent with those observed in the population with baseline blood eosinophils  $\geq 150$  cells/mcl or FeNO  $\geq 20$  ppb.

Subgroup analyses for results of Dupixent treatment based upon either baseline eosinophil level or baseline FeNO level were similar to the adolescent (12 to 17 years of age) and adult trials and are described for the adult and adolescent (12 to 17 years of age) asthma population above.

The change in percent predicted FEV1 over 52 weeks in VOYAGE in the population defined by baseline blood eosinophils  $\geq 150$  cells/mcl or FeNO  $\geq 20$  ppb is presented in **Figure 7**.

**Figure 7 – Mean Change from Baseline in Percent Predicted Pre-Bronchodilator FEV1 (L) Over Time in VOYAGE (Baseline Blood Eosinophils  $\geq 150$  cells/mcl or FeNO  $\geq 20$  ppb)**

**Baseline Blood Eosinophils  $\geq 150$  cells/mcl or FeNO  $\geq 20$  ppb**



ACQ-7-IA and PAQLQ(s)-IA were assessed in VOYAGE at 24 weeks. The responder rate was defined as an improvement in score of 0.5 or more (scale range 0-6 for ACQ-7-IA and 1-7 for PAQLQ(S)). In VOYAGE, in the population defined by baseline blood eosinophils  $\geq 150$  cells/mcl or FeNO  $\geq 20$  ppb, the ACQ-7-IA responder rate in subjects receiving Dupixent was 79.2%, and 69.3% in subjects receiving placebo and the PAQLQ(S)-IA responder rate in subjects receiving Dupixent was 73.0% versus 65.4%) in subjects receiving placebo.

## 14.2.6 - Study Results

### Chronic Rhinosinusitis with Nasal Polyps: Clinical Response (SINUS-24 and SINUS-52)

The results for primary and key secondary endpoints in CRSwNP trials are presented in the **Table 24**.

**Table 24 – Results of the Primary and Key Secondary Endpoints at Week 24 in CRSwNP Trials**

	SINUS -24					SINUS -52				
	Placebo (n=133)		Dupixent 300mg Q2W (n=143)		LS mean difference vs. Placebo (95%CI)	Placebo (n=153)		Dupixent 300mg Q2W (n=295)		LS mean difference vs. Placebo (95%CI)
<b>Primary Endpoints</b>										
Scores	Baseline mean	LS mean change	Baseline mean	LS mean change		Baseline mean	LS mean change	Baseline mean	LS mean change	
NPS	5.86	0.17	5.64	-1.89	-2.06 (-2.43, -1.69)	5.96	0.10	6.18	-1.71	-1.80 (-2.10, -1.51)
NC	2.45	-0.45	2.26	-1.34	-0.89 (-1.07, -0.71)	2.38	-0.38	2.46	-1.25	-0.87 (-1.03, -0.71)
<b>Key Secondary Endpoints</b>										
Scores	Baseline mean	LS mean change	Baseline mean	LS mean change		Baseline mean	LS mean change	Baseline mean	LS mean change	
LMK sinus CT scan score	19.55	-0.74	18.55	-8.18	-7.44 (-8.35, -6.53)	17.65	-0.09	18.12	-5.21	-5.13 (-5.80, -4.46)
UPSIT	14.44	0.70	14.68	11.26	10.56 (8.79, 12.34)	13.78	-0.81	13.53	9.71	10.52 (8.98, 12.07)
Loss of smell	2.73	-0.29	2.70	-1.41	-1.12 (-1.31, -0.93)	2.72	-0.23	2.77	-1.21	-0.98 (-1.15, -0.81)
SNOT-22	50.87	-9.31	48.0	-30.43	-21.12 (-25.17, -17.06)	53.48	-10.40	51.02	-27.77	-17.36 (-20.87, -13.85)

NC = nasal congestion, NPS = nasal polyposis score; LMK = Lund-MacKay total CT score; UPSIT = University of Pennsylvania smell identification test; SNOT-22 = 22-item sino-nasal outcome test.

(all p values <0.0001). A hierarchical testing procedure was used to strongly control the overall Type I error rate in each study. Data collected after treatment discontinuation were included in the analyses. For subjects who underwent sino-nasal surgery or received systemic corticosteroids (SCS) for any reason, data collected post-surgery or post-SCS were not utilized, and the worst post-baseline value on or before the time of surgery or SCS was used in the analysis. Missing data were imputed by multiple imputation

A reduction in score indicates improvement, except UPSIT where an increase indicates improvement.

The results of SINUS-52 trial at week 52 are presented in **Table 25**.

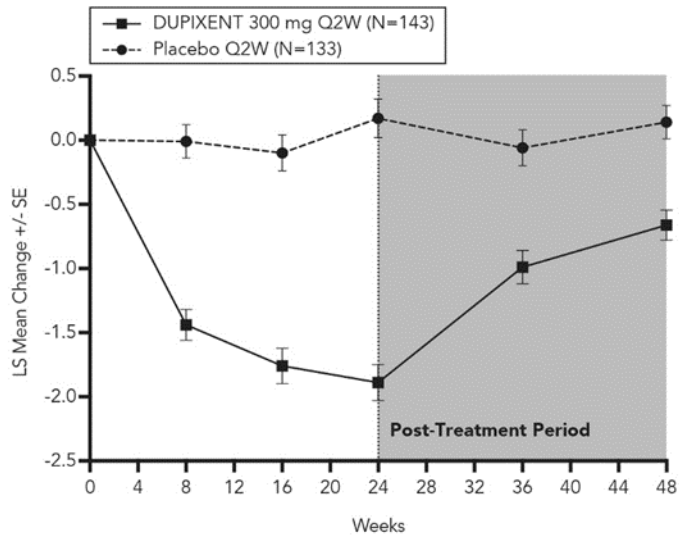
<b>Table 25 - Results of the efficacy at week 52 in SINUS-52 study</b>					
	<b>Placebo (n=153)</b>		<b>Dupixent 300mg Q2W (n=150)</b>		<b>LS mean difference vs. Placebo (95%CI)</b>
	Baseline mean	LS mean change	Baseline mean	LS mean change	
NPS	5.96	0.15	6.07	-2.24	-2.40 (-2.77, -2.02)
NC	2.38	-0.37	2.48	-1.35	-0.98 (-1.17, -0.79)
SNOT-22	53.48	-8.88	50.16	-29.84	-20.96 (-25.03, -16.89)

A reduction in score indicates improvement

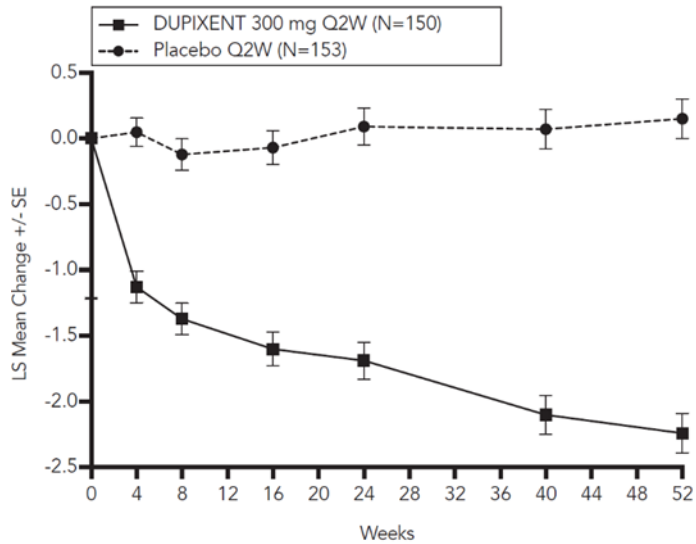
NC = nasal congestion, NPS = nasal polyposis score; SNOT-22 = 22-item sino-nasal outcome test. (all p values <0.0001). A hierarchical testing procedure was used to strongly control the overall Type I error rate in each study. Data collected after treatment discontinuation were included in the analyses. For subjects who underwent sino-nasal surgery or received systemic corticosteroids (SCS) for any reason, data collected post-surgery or post-SCS were not utilized, and the worst post-baseline value on or before the time of surgery or SCS was used in the analysis. Missing data were imputed by multiple imputation.

Statistically significant differences were observed in SINUS-24 and SINUS-52 with regard to improvement in bilateral endoscopic NPS at Week 24 and at Week 52 in SINUS-52 following continuous treatment with Dupixent (Figure 7 and Figure 8). During the post-treatment period of SINUS-24 (e.g., Weeks 24-48) when subjects no longer received Dupixent, the treatment effect diminished over time (see **Figure 8**).

**Figure 8 – LS mean change from baseline in bilateral nasal polyps score (NPS) up to Week 48 in SINUS-24 - ITT population.**

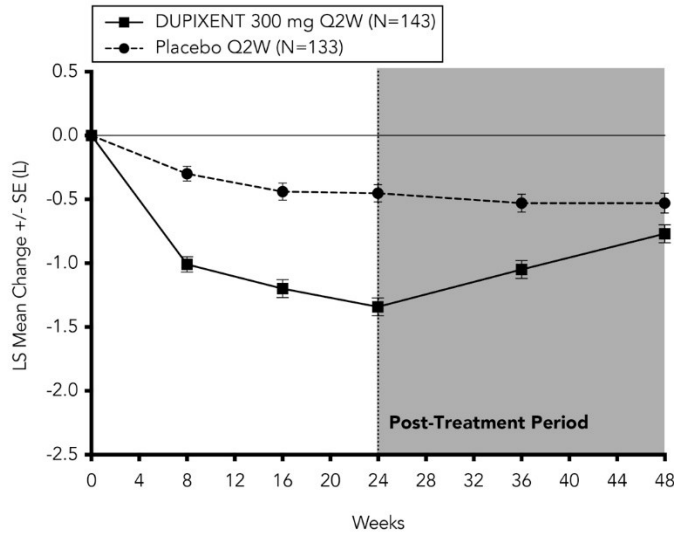


**Figure 9 – LS mean change from baseline in bilateral nasal polyps score (NPS) up to Week 52 in SINUS-52 - ITT population.**

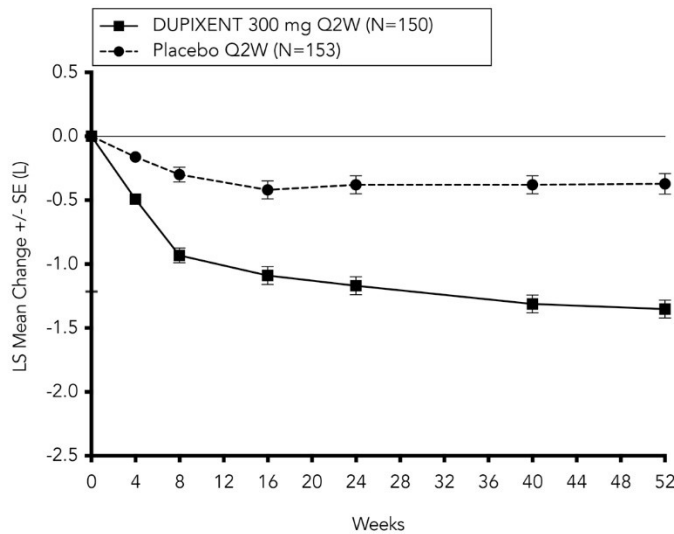


Statistically significant differences were observed in SINUS-24 and SINUS-52 with regard to improvement in NC at Week 24 and at Week 52 in SINUS-52 following continuous treatment with Dupixent (Figure 9 and Figure 10). During the post-treatment period of SINUS-24 (e.g., Weeks 24-48) when subjects no longer received Dupixent, the treatment effect diminished over time (see Figure 10).

**Figure 10 – LS mean change from baseline in nasal congestion score (NC) up to Week 48 in SINUS-24 - ITT population.**



**Figure 11 – LS mean change from baseline in nasal congestion score (NC) up to Week 52 in SINUS-52 - ITT population.**

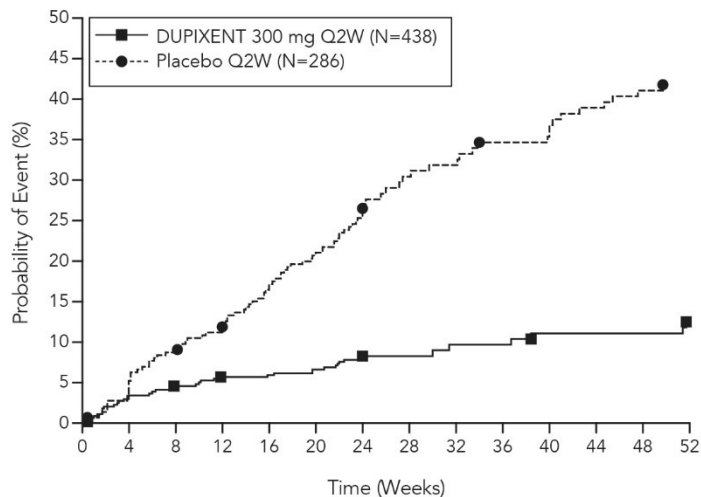


Changes in LMK, UPSIT, and loss of smell scores at Week 52 were consistent with results observed at Week 24.

In the pre-specified multiplicity-adjusted pooled analysis of the two trials (up to Week 24 for SINUS-24 and up to Week 52 for SINUS-52), treatment with Dupixent resulted in significant reduction of systemic corticosteroid use or need for sino-nasal surgery (actual or planned) versus placebo (HR of 0.24; 95% CI: 0.17, 0.35) (see Figure 11).

In the pooled analysis, the proportion of subjects who required systemic corticosteroid use over the 52-week period was 12.3% in the Dupixent group and 38.0% in the placebo group. The proportion of subjects who required sino-nasal surgery over the 52-week period was 1.2% in the Dupixent group and 10.2% in the placebo group.

**Figure 12 – Kaplan Meier Curve for time-to-first systemic corticosteroid use or sino-nasal surgery during treatment period - ITT population [SINUS-24 and SINUS-52 pooled]**



	Number at Risk							
	0	4	8	12	24	36	48	52
DUPIXENT 300 mg Q2W	438	416	411	376	129			100
Placebo Q2W	286	260	253	187	93			61

Changes in NPS, NC, and LMK scores in favour of dupilumab were consistent between subjects with CRSwNP with or without comorbid asthma.

In subjects with CRSwNP and co-morbid asthma, improvements in pre-bronchodilator FEV1 were consistent with those observed in the asthma program.

**14.2.7- Study Results: Eosinophilic Esophagitis**

The results for TREET Parts A and B are presented in **Table 26**.

**Table 26: Efficacy Results of Dupixent at Week 24 in Subjects 12 Years of Age and Older with EoE (TREET Parts A and B)**

	TREET Part A <sup>a</sup>			TREET Part B <sup>a</sup>		
	Dupixent 300 mg QW N = 42	Placebo N = 39	Difference vs. Placebo (95% CI) <sup>b</sup>	Dupixent 300 mg QW N = 80	Placebo N = 79	Difference vs. Placebo (95% CI) <sup>b</sup>
<b>Co-primary endpoints</b>						
Proportion of patients achieving histological remission (peak esophageal intraepithelial eosinophil count ≤6 eos/hpf), n (%)	25 (59.5)	2 (5.1)	55.3 (39.58, 71.04) <sup>c</sup>	47 (58.8)	5 (6.3)	53.5 (41.20, 65.79) <sup>c</sup>

Absolute change from baseline in DSQ score (0-84 <sup>d</sup> ), LS mean (SE)	-21.92 (2.53)	-9.60 (2.79)	-12.32 (-19.11, -5.54) <sup>c</sup>	-23.78 (1.86)	-13.86 (1.91)	-9.92 (-14.81, -5.02) <sup>c</sup>
<b>Secondary endpoint</b>						
Absolute change from baseline in EoE-EREFS (0-18 <sup>e</sup> ), LS mean (SE)	-3.2 (0.41)	-0.3 (0.41)	-2.9 (-3.91, -1.84) <sup>c</sup>	-4.5 (0.36)	-0.6 (0.38)	-3.8 (-4.77, -2.93)

<sup>a</sup> Subjects stratified at randomization by age at the time of the screening visit (adult vs. adolescent) and by current use of proton-pump inhibitor (yes vs. no).

<sup>b</sup> Absolute difference in proportions for categorical endpoints and LS mean difference for continuous endpoints.

<sup>c</sup> Statistically significant ( $p < 0.05$ ). For histological remission, the difference in percentages is estimated using the Cochran Mantel Haenszel method, adjusting for randomization stratification factors. For absolute change in DSQ score, the LS mean changes, standard errors, and differences are estimated using an ANCOVA model with treatment group, randomization stratification factors, and baseline measurement as covariates.

<sup>d</sup> Total biweekly DSQ scores range from 0 to 84; higher scores indicate greater frequency and severity of dysphagia.

<sup>e</sup> EoE-EREFS overall scores range from 0 to 18; higher scores indicate worse endoscopic inflammatory and/or remodeling features of the esophagus.

In TREET Parts A and B, a greater proportion of subjects randomized to Dupixent achieved histological remission (peak esophageal intraepithelial eosinophil count  $\leq 6$  eos/hpf) compared to placebo at Week 24. Additionally, subjects randomized to Dupixent had a favourable change in DSQ score compared to placebo at Week 24, which represented a within-subject clinically meaningful improvement.

Subjects randomized to Dupixent had a favourable change in endoscopic scoring (EoE-EREFS) of inflammatory and remodeling features of EoE compared to placebo at Week 24.

The proportion of subjects achieving a histological response (peak esophageal intraepithelial eosinophil count  $< 15$  eos/hpf) at Week 24 with Dupixent was 64.3% in Part A and 82.5% in Part B, whereas the proportion was 7.6% with placebo (in both Parts A and B).



### **14.2.8 - Study Results: Prurigo Nodularis**

The efficacy results for PRIME and PRIME2 are presented in **Table 27**.

**Table 27: Results of the Primary and Key Secondary Endpoints in PRIME and PRIME2**

	PRIME			PRIME2		
	Placebo (N=76)	Dupixent 300 mg Q2W (N=75)	Difference (95% CI) for DUPIXENT vs. Placebo <sup>a</sup>	Placebo (N=82)	Duipxent 300 mg Q2W (N=78)	Difference (95% CI) for DUPIXENT vs. Placebo <sup>a</sup>
Proportion of patients with improvement (reduction) in WI-NRS by $\geq 4$ points from baseline at week 24 (Primary endpoint in PRIME) <sup>b</sup>	18.4%	60.0%	42.7% (27.76, 57.72)	19.5%	57.7%	42.6% (29.06, 56.08)
Proportion of patients with improvement (reduction) in WI-NRS by $\geq 4$ points from baseline at week 12. (Primary endpoint in PRIME2) <sup>b</sup>	15.8% <sup>a</sup>	44.0% <sup>a</sup>	29.2% (14.49, 43.81) <sup>c</sup>	22.0%	37.2%	16.8% (2.34, 31.16)
Proportion of patients with IGA PN-S 0 or 1 at week 24. <sup>b</sup>	18.4%	48.0%	28.3% (13.41, 43.16)	15.9%	44.9%	30.8% (16.37, 45.22)
Proportion of patients with both an improvement (reduction) in WI-NRS by $\geq 4$ points from baseline to Week 24 and an IGA PN-S 0 or 1 at Week 24 <sup>b</sup>	9.2%	38.7%	29.6% (16.42, 42.81)	8.5%	32.1%	25.5% (13.09, 37.86)

<sup>a</sup> Cochran-Mantel Haenszel (CMH) derived response rate difference, adjusted by randomization stratification factors (history of atopy [atopic or non-atopic], stable use of TCS/TCI [yes or no], and region), and baseline anti-depressant use.

<sup>b</sup> Subjects who received rescue treatment earlier or had missing data were considered as non-responders.

<sup>c</sup> Not adjusted for multiplicity in PRIME.

The Dermatology Life Quality Index (DLQI) score ranges from 0 to 30. The LS mean change from baseline in DLQI score (SE) at Week 24 was -11.97 (1.02) and -13.16 (1.21) in patients receiving Dupixent in PRIME and PRIME2, respectively, and -5.77 (1.05) and -6.77 (1.18) in patients receiving placebo in PRIME and PRIME2, respectively.

## **15. MICROBIOLOGY**

No microbiological information is required for this drug product.

## 16. NON-CLINICAL TOXICOLOGY

Dupilumab binds specifically to human IL-4R $\alpha$  and does not react with any other animal species. Pivotal toxicology studies were therefore conducted using surrogate antibodies against the IL-4R $\alpha$  of cynomolgus monkeys and CD-1 mice.

### **General Toxicology:**

No significant adverse effects were observed in cynomolgus monkeys when administered a surrogate antibody against IL-4R $\alpha$  by subcutaneous or intravenous injection up to dose levels of 100 mg/kg/week for 6 months. Serum drug levels achieved at these dosages were sufficient to have fully saturated the monkey IL-4R $\alpha$ .

### **Carcinogenicity:**

Carcinogenicity studies have not been conducted with dupilumab.

### **Genotoxicity:**

Genotoxicity studies have not been conducted with dupilumab.

### **Reproductive and Developmental Toxicology:**

No significant adverse embryofetal, morphological, functional or immunological developmental effects were observed in offspring of pregnant cynomolgus monkeys exposed to a surrogate antibody against IL-4R $\alpha$  by subcutaneous injection from the beginning of organogenesis through parturition up to dose levels of 100 mg/kg/week. The overall rate of embryofetal loss during gestation was 5 of 20 (25%) in control animals, 10 of 20 (50%) in animals treated with 25 mg/kg/week, and 3 of 18 (17%) in animals treated with 100 mg/kg/week. Concentrations of the surrogate antibody observed in the infant monkeys at birth were comparable to those observed in maternal serum, indicating placental transfer.

No effects on fertility parameters, including reproductive organs, menstrual cycle length, or sperm analyses were observed in sexually mature mice receiving a murine surrogate antibody against IL-4R $\alpha$  by subcutaneous injection up to dose levels of 200 mg/kg/week.

### **Juvenile Toxicity:**

No juvenile toxicology studies have been conducted with dupilumab or any of its surrogates.

## PATIENT MEDICATION INFORMATION

### READ THIS FOR SAFE AND EFFECTIVE USE OF YOUR MEDICINE

Pr **DUPIXENT**<sup>®</sup>

#### Dupilumab injection

#### solution for subcutaneous injection

**DUPIXENT 300 mg single-use syringe (300 mg/2 mL) in pre-filled syringe with or without needle shield or pre-filled pen**

**DUPIXENT 200 mg single-use syringe (200 mg/1.14 mL) in pre-filled syringe with needle shield or pre-filled pen**

Read this carefully before you start taking **Dupixent** and each time you get a refill. This leaflet is a summary and will not tell you everything about this drug. Talk to your healthcare professional about your medical condition and treatment and ask if there is any new information about **Dupixent**.

#### **What is Dupixent used for?**

Dupixent is an injectable prescription medicine used to:

##### **Atopic Dermatitis**

- To treat patients aged 6 months and older with moderate-to-severe atopic dermatitis, also known as atopic eczema. Dupixent can be used with or without topical corticosteroids.
- It is not known if Dupixent is safe and effective in children with atopic dermatitis below age of 6 months.

##### **Asthma**

- In addition to other asthma medicines for maintenance treatment of adults, adolescents and children (6 years and older) with severe asthma with a type 2/eosinophilic phenotype or oral corticosteroid-dependent asthma, whose asthma is not controlled with their current asthma medicines. Severe eosinophilic asthma is a type of asthma where patients have increased eosinophils in the blood or lungs. Eosinophils are a type of white blood cell that are associated with inflammation of the airways that can cause your asthma to get worse or can increase the number of asthma attacks.
- It is not known if Dupixent is safe and effective in children with asthma below age of 6 years.
- Dupixent is not used to treat sudden breathing problems.

##### **Chronic Rhinosinusitis with Nasal Polyposis**

- To treat adult patients with severe chronic rhinosinusitis with nasal polyposis (CRSwNP) in combination with intranasal corticosteroids, whose disease is not controlled with systemic corticosteroids or surgery.
- It is not known if Dupixent is safe and effective in children below age of 18 years.

## **Eosinophilic Esophagitis**

- To treat adults and adolescent patients aged 12 years and older, who weigh at least 40 kg, with eosinophilic esophagitis (EoE).

## **Prurigo Nodularis**

- Treat adult patients with moderate-to-severe prurigo nodularis (PN) whose disease is not adequately controlled with topical prescription therapies or when those therapies are not advisable. Dupixent can be used with or without topical corticosteroids.
- It is not known if Dupixent is safe and effective in children below age of 18 years.

## **How does Dupixent work?**

Dupixent contains the active substance dupilumab.

Dupilumab is a monoclonal antibody (a type of specialized protein) that blocks the action of inflammatory proteins called IL-4 and IL-13. IL-4 and IL-13 contribute to signs and symptoms of atopic dermatitis, asthma, CRSwNP, EoE and prurigo nodularis.

Using Dupixent for atopic dermatitis can improve the condition of your skin and reduce itch.

Using Dupixent for severe eosinophilic asthma can reduce severe asthma attacks and improve your breathing. Dupixent may also help reduce the amount of another group of medicines you need to control your severe asthma, called oral corticosteroids, while reducing severe asthma attacks and improving your breathing.

Using Dupixent for CRSwNP can decrease the size of your nasal polyps, decrease your nasal congestion, and improve your sense of smell.

Using Dupixent for EoE can improve the swallowing difficulties associated with eating food and may reduce your need to clear food (e.g., drink liquid, cough, vomit, or seek medical intervention).

Using Dupixent for prurigo nodularis can improve the condition of your skin with reduction of itch and improvement of lesions.

## **What are the ingredients in Dupixent?**

Medicinal ingredients: dupilumab

Non-medicinal ingredients: acetic acid, L-arginine hydrochloride, L-histidine, polysorbate 80, sodium acetate, sucrose, water for injection.

## **Dupixent comes in the following dosage forms:**

Dupixent comes as a single-use (1 time use) pre-filled syringe with or without needle shield or pre-filled pen. Your healthcare provider will prescribe the type that is best for you.

**Do not use Dupixent if:**

Do not use Dupixent if you are allergic to dupilumab or to any of the ingredients in Dupixent.

Dupixent can potentially cause serious side effects, including generalized allergic (hypersensitivity) reactions and anaphylactic reaction. Check for signs or symptoms of these conditions (i.e. breathing problems, swelling of the face, lips, mouth, throat or tongue, fainting, dizziness, feeling lightheaded (low blood pressure), fever, general ill feeling, swollen lymph nodes, hives, itching, joint pain, skin rash) while you are taking Dupixent. Stop taking Dupixent and tell your healthcare professional or seek medical help immediately if you experience any signs or symptoms of an allergic reaction (see also the table “Serious side effects and what to do about them” below).

**To help avoid side effects and ensure proper use, talk to your healthcare professional before you take Dupixent. Talk about any health conditions or problems you may have, including if you:**

- have a parasitic (intestinal parasites) infection. Dupixent may weaken your resistance to infections caused by parasites. If you already have a parasitic infection, it should be treated before you start treatment with Dupixent. If you live in a region where these infections are common or if you are travelling to such a region, check with your doctor.
- are pregnant or plan to become pregnant. It is not known if Dupixent will harm your unborn baby. Tell your healthcare provider if you become pregnant while taking Dupixent.
- are breastfeeding or plan to breastfeed. You and your healthcare provider should decide if you will take Dupixent or breastfeed. You should not do both without talking to your healthcare provider first.
- have other allergic conditions such as asthma and are taking asthma medicines.
- are scheduled to receive a vaccination
- have eye problems (e.g. itching, redness)

**Other warnings you should know about:**

Dupixent is not a rescue medicine and should not be used to treat a sudden asthma attack.

Do not stop or reduce your asthma medicines, unless instructed by your healthcare professional. These medicines (especially ones called *corticosteroids*) must be stopped gradually, under the direct supervision of your healthcare professional. Rarely patients taking Dupixent may develop inflammation of blood vessels or lungs due to an increase of certain white blood cells (eosinophilia).

This usually, but not always, happens in people who also take corticosteroids, which are being stopped or for which the dose is being lowered. Tell your healthcare professional immediately if you develop a combination of symptoms such as a persistent fever, shortness of breath, chest pain, rash, and/or pins and needles or numbness of arms or legs.

There is no experience with Dupixent in children with atopic dermatitis less than 6 months of age. Therefore, the use of Dupixent is not recommended in this age group.

**Tell your healthcare professional about all the medicines you take, including any drugs, vitamins, minerals, natural supplements or alternative medicines.**

**The following may interact with Dupixent:**

Inform your healthcare professional that you are taking Dupixent if you recently received a vaccine or if you are about to receive a vaccine. Dupixent should not be used at the same time with certain types of vaccines.

### **How to take Dupixent:**

Always check the label of your pre-filled syringe or pen before each injection to make sure you have the correct product.

Dupixent should be allowed to reach room temperature by waiting for 45 minutes (for 300 mg pre-filled syringe or pen) and 30 minutes (for 200 mg pre-filled syringe or pen) after removing from the refrigerator before injecting.

The Dupixent pre-filled pen is not intended for use in pediatrics below 2 years of age. For children aged 6 months to 2 years of age, contact your doctor who will prescribe the appropriate Dupixent pre-filled syringe.

In children 6 months to less than 12 years of age, Dupixent should be given by a caregiver. In children 12 years of age and older, it is recommended that Dupixent be administered by or under supervision of an adult.

Dupixent is injected under the skin (subcutaneous use) of your upper leg (thigh), or stomach area (abdomen, except 5 cm around your belly button); if somebody else gives you the injection, you can also use the upper arm. Choose a different spot each time you inject (e.g. right thigh then left thigh, or right abdomen then left abdomen). Do not inject into skin that is tender, damaged or has bruises or scars.

Do not inject Dupixent together with other injectable medicines at the same injection site.

It is important that you do not stop using Dupixent without talking with your healthcare provider. Prior to discontinuing Dupixent check with your healthcare professional if you need to adjust your treatment or need to manage other allergic and or atopic conditions.

Do not use Dupixent for a condition for which it was not prescribed. Do not give Dupixent to other people, even if they have the same signs or symptoms that you have; it may harm them.

### ***Learning how to use the pre-filled syringe (with or without needle shield) or pre-filled pen***

- Before you use the pre-filled syringe or pen for the first time, your healthcare professional will show you or your caregiver how to inject Dupixent. Do not try to inject Dupixent until you or your caregiver have been shown the correct way by your healthcare provider.
- Always read and use the pre-filled syringe or pen as described by the "Instructions for Use" provided in the box.

### **Usual dose:**

Use Dupixent exactly as prescribed by your healthcare professional.

#### Atopic Dermatitis

#### Recommended dose in adults

In atopic dermatitis, the first time you use Dupixent you will receive 600 mg (two (2) subcutaneous

injections of 300 mg each given in 2 different injection sites). Thereafter, Dupixent is given as a 300 mg subcutaneous injection once every other week.

Recommended dose for pediatrics (6 to 17 years of age)

The recommended dose of Dupixent for pediatrics (6 to 17 years of age) with atopic dermatitis is based on body weight:

<b>Body Weight</b>	<b>Initial Dose</b>	<b>Subsequent Doses</b>
15 to less than 30 kg	600 mg (two 300 mg injections)	300 mg every 4 weeks <b>(Q4W)</b>
30 to less than 60 kg	400 mg (two 200 mg injections)	200 mg every other week <b>(Q2W)</b>
60 kg or more	600 mg (two 300 mg injections)	300 mg every other week <b>(Q2W)</b>

Pediatrics (6 months to 5 years of age)

The recommended dose of Dupixent for pediatrics 6 months to 5 years of age is specified in the below Table.

**Table: Dose of Dupixent for Subcutaneous Administration in Pediatric Patients 6 months to 5 Years of Age with Atopic Dermatitis**

<b>Body Weight</b>	<b>Initial Dose</b>	<b>Subsequent Doses</b>
5 to less than 15 kg	200 mg (one 200 mg injection)	200 mg every 4 weeks <b>(Q4W)</b>
15 to less than 30 kg	300 mg (one 300 mg injection)	300 mg every 4 weeks <b>(Q4W)</b>

Asthma

In severe eosinophilic asthma, the recommended dose of Dupixent for adult and adolescents (12 years of age and older) is:

- A first dose of 400 mg (two (2) injections under the skin of 200 mg) followed by 200 mg every two weeks by injection. The dose may be increased to 300 mg every two weeks based on your healthcare professional’s assessment.

In severe asthma needing oral corticosteroids, the recommended dose of Dupixent for adults and adolescents (12 years of age and older) is:

- A first dose of 600 mg (two (2) injections under the skin of 300 mg) followed by 300 mg every two weeks by injection.

The recommended dose of Dupixent for children 6 to 11 years is based on body weight:

<b>Body Weight</b>	<b>Initial and Subsequent Doses</b>
15 to less than 30 kg	300 mg every four weeks <b>(Q4W)</b>
30 to less than 60 kg	200 mg every other week <b>(Q2W)</b> or 300 mg every four weeks <b>(Q4W)</b>
60 kg or more	200 mg every other week <b>(Q2W)</b>

CRSwNP

In CRSwNP, Dupixent is given as a 300 mg subcutaneous injection once-every-other week.

### Eosinophilic Esophagitis

The recommended dose of Dupixent for patients 12 years of age and older, weighing at least 40 kg, is 300 mg given every week (QW).

### Prurigo Nodularis

The recommended dose of Dupixent for adult patients is an initial dose of 600 mg (two 300 mg injections), followed by 300 mg given every other week.

### **Overdose:**

If you think you, or a person you are caring for, have taken too much Dupixent, contact a healthcare professional, hospital emergency department, or regional poison control centre immediately, even if there are no symptoms.

### **Missed Dose:**

- **If your dose schedule is every week and you miss a dose of Dupixent:** Give the dose as soon as possible, starting a new weekly schedule based on this date.
- **If your dose schedule is every other week and you miss a dose of Dupixent:** Give the Dupixent injection within 7 days from the missed dose, then continue with your original schedule. If the missed dose is not given within 7 days, wait until the next scheduled dose to give your Dupixent injection.
- **If your dose schedule is every 4 weeks and you miss a dose of Dupixent:** Give the Dupixent injection within 7 days from the missed dose, then continue with your original schedule. If the missed dose is not given within 7 days, start a new every 4 week dose schedule from the time you remember to take your Dupixent injection.

### **What are possible side effects from using Dupixent?**

Dupixent may cause **allergic reactions (hypersensitivity)**, including a severe reaction known as anaphylaxis. Stop using Dupixent and tell your healthcare professional or seek medical help immediately if you notice any signs or symptoms of an allergic reaction, such as:

- breathing problems
- swelling of the face, lips, mouth, throat or tongue (angioedema)
- fever
- feeling ill
- swollen lymph nodes
- hives
- itching
- skin rash
- skin or eyelid itching
- joint pain
- fainting, dizziness, feeling lightheaded (low blood pressure)

Dupixent may cause **eye problems**, including eye pain or change in vision. Tell your healthcare professional if you have any new or worsening eye problems.



These are not all the possible side effects you may experience when taking Dupixent. If you experience any side effects not listed here, contact your healthcare professional. Please also see “Do not use Dupixent if” section above.

The most common side effects of Dupixent include:

- injection site reactions
- eye and eyelid inflammation, including redness, swelling, itching, and/or dryness, sometimes with blurred vision
- eye infections
- cold sores in your mouth or on your lips (oral herpes)
- extra high amount of a certain white blood cell (eosinophilia)
- trouble sleeping (insomnia)
- gastritis
- joint pain (arthralgia)
- headache
- facial rash or redness
- parasitic helminth infections

Serious side effects and what to do about them			
Symptom / effect	Talk to your healthcare professional		Stop taking drug and get immediate medical help
	Only if severe	In all cases	
<b>UNCOMMON</b>			
Allergic reactions (hypersensitivity)			✓

If you have a troublesome symptom or side effect that is not listed here or becomes bad enough to interfere with your daily activities, tell your healthcare professional.

### Reporting Side Effects

You can report any suspected side effects associated with the use of health products to Health Canada by:

- Visiting the Web page on Adverse Reaction Reporting (<https://www.canada.ca/en/health-canada/services/drugs-health-products/medeffect-canada.html>) for information on how to report online, by mail or by fax; or
- Calling toll-free at 1-866-234-2345.

*NOTE: Contact your health professional if you need information about how to manage your side effects. The Canada Vigilance Program does not provide medical advice.*

**Storage:**

Keep out of reach and sight of children.

Do not use this medicine after the expiry date which is stated on the label and carton.

Store in a refrigerator (2°C - 8°C). Do not freeze.

Keep the syringe or pen in the outer carton in order to protect from light.

Do not expose to extreme heat.

Dupixent should be allowed to reach room temperature by waiting for 45 minutes (for 300 mg pre-filled syringe or pen) or 30 minutes (for 200 mg pre-filled syringe or pen) after removing from the refrigerator before injecting.

If necessary, pre-filled syringes or pens may be kept at room temperature up to 25°C, away from direct heat and light, for a maximum of 14 days. Do not store above 25°C. After removal from the refrigerator, Dupixent must be used within 14 days or discarded.

Do not use this medicine if the solution is discolored or cloudy, or if it contains visible flakes or particles.

The pre-filled pen may either have a round cap and oval viewing window encircled with an arrow or may have a square cap with ridges and an oval viewing window without an arrow. Although there are minor differences in the appearance of the two pre-filled pens, they both function the same.

After use, put the syringe or pen into a puncture-resistant container. Always keep the container out of the reach of children. Ask your health care provider or pharmacist how to throw away the container. Do not recycle the container.

Do not throw away any medicines via wastewater or household waste. Ask your pharmacist how to throw away medicines you no longer use. These measures will help protect the environment.

**If you want more information about Dupixent:**

- Talk to your healthcare professional
- Find the full product monograph that is prepared for healthcare professionals and includes this Patient Medication Information by visiting the Health Canada website: (<https://www.canada.ca/en/health-canada/services/drugs-health-products/drug-products/drug-product-database.html>); the manufacturer's website [www.sanofi.ca](http://www.sanofi.ca), or by calling 1 800 265-7927.

This leaflet was prepared by sanofi-aventis Canada Inc.

Dupixent<sup>®</sup> is a registered trademark of Sanofi Biotechnology, SA.

Last revised: March 14, 2024

## INSTRUCTIONS FOR USE

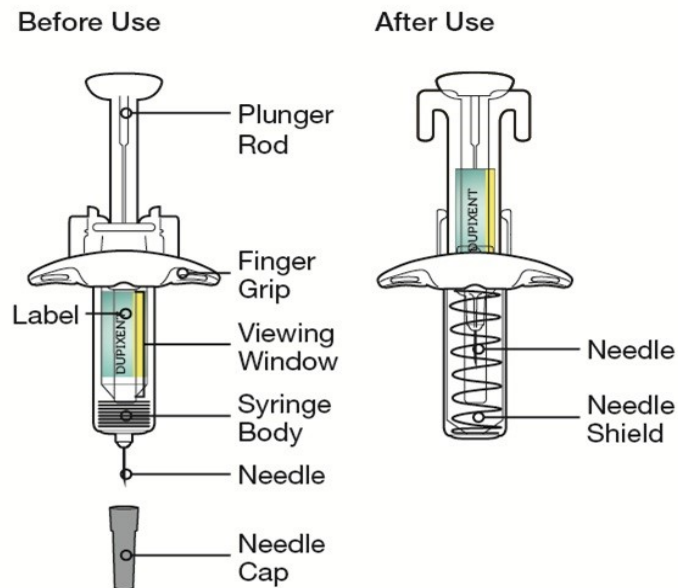
### DUPIXENT 300 MG SINGLE-USE PRE-FILLED SYRINGE WITH NEEDLE SHIELD

Read the 'Instructions for Use' before using the Dupixent Pre-filled Syringe with needle shield. Do not inject yourself or someone else until you have been trained by a healthcare professional on how to prepare a dose and inject Dupixent. In adolescent 12 years of age and older, it is recommended that Dupixent be administered by or under the supervision of an adult. In children less than 12 years of age, Dupixent should be given by a caregiver.

This device is a **Single-use** Pre-filled Syringe (called "Syringe" in these instructions) with a needle shield. It contains 300 mg of Dupixent for injection under the skin (subcutaneous injection).

**Keep these instructions for future use. If you have any further questions, you should ask your healthcare provider or call 1 800 265-7927.**

The parts of the Dupixent syringe are shown in this picture.



### Important Information

- |   |   |
|---|---|
| <ul style="list-style-type: none"><li>• It is important that you do not try to give yourself or someone else the injection unless you have received training from your healthcare provider.</li><li>• Read all of the instructions carefully before using the Syringe.</li><li>• Ask your healthcare provider how often you will need to inject the medicine.</li><li>• Ask your healthcare provider to show you the right way to use the Syringe before you inject for the first time.</li><li>• Rotate the injection site each time you inject.</li><li>• To reduce the risk of accidental needle sticks, each pre-filled syringe has a needle shield that is automatically activated to cover the needle after you have given your injection</li></ul> | <ul style="list-style-type: none"><li>• <b>Do not</b> use the Syringe if it has been dropped on a hard surface or damaged.</li><li>• <b>Do not</b> use the Syringe if the Needle Cap is missing or not securely attached.</li><li>• <b>Do not</b> touch the Plunger Rod until you are ready to inject.</li><li>• <b>Do not</b> inject through clothes.</li><li>• <b>Do not</b> get rid of any air bubbles in the Syringe.</li><li>• <b>Do not</b> pull back on the Plunger Rod at any time.</li><li>• <b>Do not</b> re-use the Syringe.</li></ul> |
|---|---|

### How to Store Dupixent:

- Keep the Syringe(s) out of the reach of children.
- Keep unused Syringes in the original carton and store in the refrigerator between 2°C and 8°C.
- Remove the Syringe from the refrigerator at least 45 minutes before your injection so that it reaches room temperature.
- **Do not** keep Dupixent at room temperature for more than 14 days.
- **Do not** shake the Syringe at any time.
- **Do not** heat the Syringe.
- **Do not** freeze the Syringe.
- **Do not** put the Syringe into direct sunlight.

### How to Dispose of (Throw Away) Used Syringes

Put your used Needles and Syringes in a-puncture-resistant container right away after use.



**Do not dispose of (throw away) the Syringes in your household trash.**

If you do not have a puncture-resistant container, you may use a household container that is:

- made of a heavy-duty plastic;

- can be closed with a tightfitting, puncture-resistant lid, without sharps being able to come out,
- upright and stable during use,
- leak-resistant, and
- properly labeled to warn of hazardous waste inside the container

When your puncture-resistant container is almost full, you will need to follow your provincial or local regulations for the correct way to dispose of it.

### **Step 1: Remove**

Remove the Syringe from the carton by holding the middle of the Syringe Body:



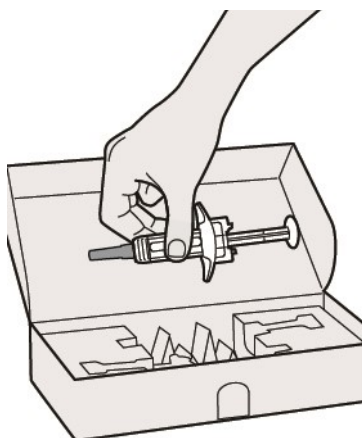
**Do not pull off the Needle Cap until you are ready to inject.**



**Do not use the Syringe if it has been dropped on a hard surface or damaged.**



**Do not keep Dupixent at room temperature for more than 14 days.**



### **Step 2: Prepare**

Ensure you have the following:

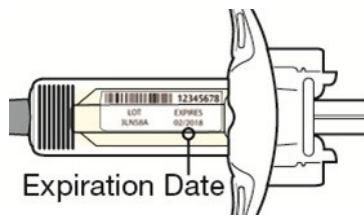
- the Dupixent Pre-filled Syringe with needle shield
- 1 alcohol wipe\*
- 1 cotton ball or gauze\*
- a puncture-resistant container\* (See Step 12)

*\*Items not included in the carton*

Look at the label:

- Check the expiration date
- Check that you have the correct product and dose

 Do not use the Syringe if the expiration date has passed.



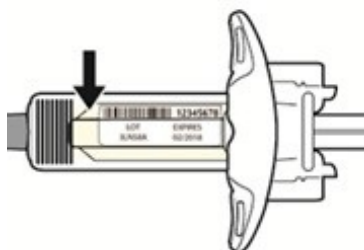
### **Step 3: Inspect**

Look at the medicine through the viewing window on the Syringe:

Check if the liquid is clear and colorless to pale yellow.

*Note: You may see an air bubble; this is normal.*

 Do not use the Syringe if the liquid is discolored or cloudy, or if it contains visible flakes or particles.



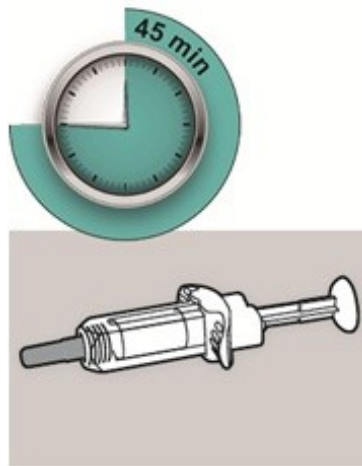
### **Step 4: Wait 45 minutes**

Lay the Syringe on a flat surface and let it naturally warm to room temperature for at least 45 minutes.

 Do not heat the Syringe.

 Do not put the Syringe into direct sunlight.

 Do not keep Dupixent at room temperature for more than 14 days.

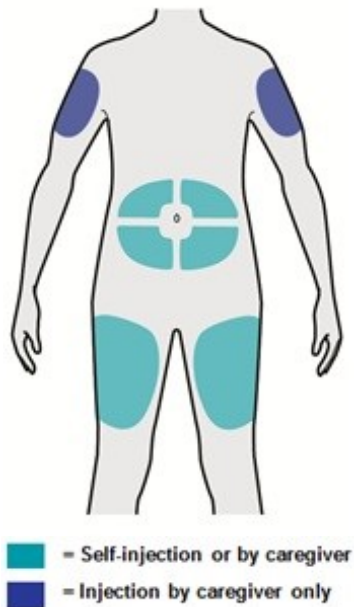


### **Step 5: Select**

Select the injection site.

- You can inject into your thigh or stomach, except for the 5 cm (2 inches) around your navel (belly-button)
- If somebody else gives you the injection, you can also use the upper arm.
- Change the injection site for each injection.

 Do not inject into skin that is tender, damaged or has bruises or scars.



### **Step 6: Clean**

Wash your hands.

Clean the injection site with an alcohol wipe.

Let your skin dry before injecting.

 **Do not touch the injection site again or blow on it before the injection.**



### **Step 7: Pull**

Hold the Syringe in the middle of the Syringe Body with the Needle pointing away from you and pull off the Needle Cap.

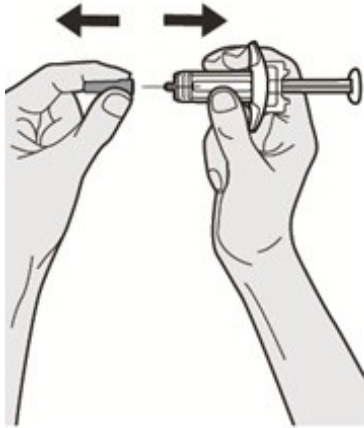
 **Do not put the Needle Cap back on.**

 **Do not touch the Needle.**

 **Do not inject if the Needle is damaged**

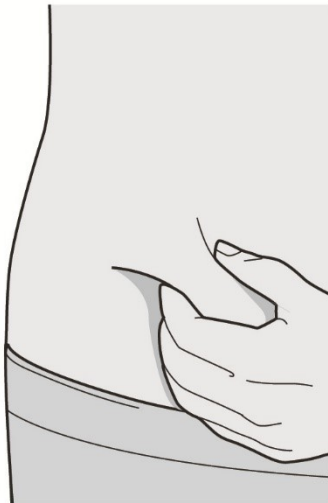
Inject your medicine immediately after removing the Needle Cap.





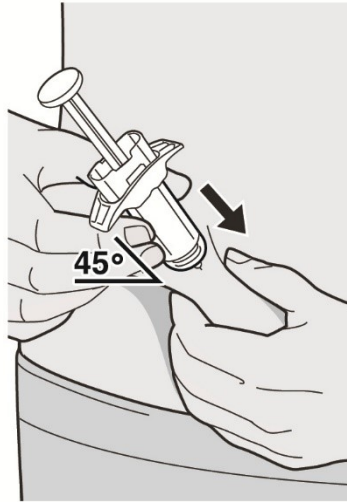
**Step 8: Pinch**

Pinch a fold of skin at the injection site, as shown in the picture.



**Step 9: Insert**

Insert the Needle completely into the fold of the skin at roughly a 45° angle.



### **Step 10: Push**

Relax the pinch.

Push the Plunger Rod down slowly and steadily as far as it will go until the Syringe is empty.

*Note: You will feel some resistance. This is normal.*



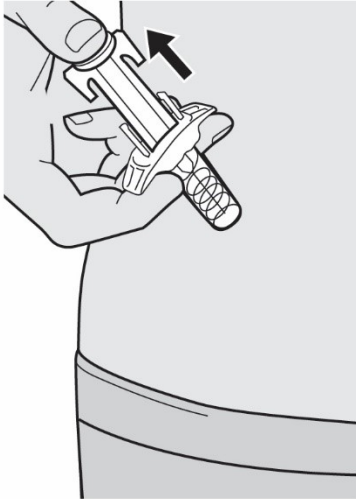
### **Step 11: Release and Remove**

Lift your thumb to release the plunger rod until the needle is covered by the needle shield and then remove the syringe from the injection site.

Lightly press a cotton ball or gauze on the injection site if you see any blood.

 **Do not put the Needle Cap back on.**

 **Do not rub your skin after the injection**



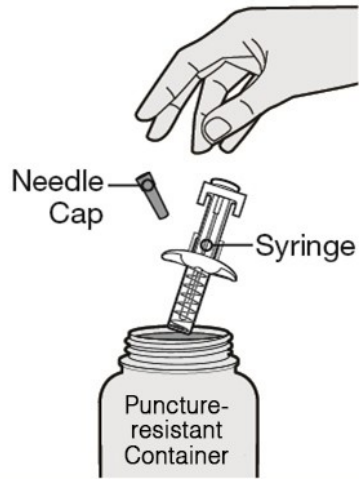
### **Step 12: Dispose**

Dispose of the Syringe and the Needle Cap in a puncture-resistant container.

 **Do not put the Needle Cap back on.**

Always keep the container out of the reach of children.

See “How to Dispose of (Throw Away) Used Syringes”.



## INSTRUCTIONS FOR USE

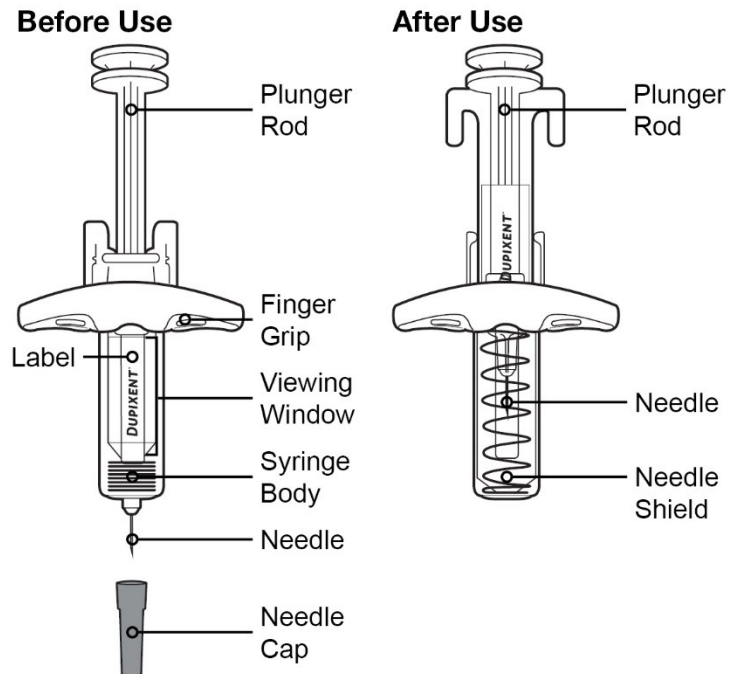
### DUPIXENT 200 MG SINGLE-USE PRE-FILLED SYRINGE WITH NEEDLE SHIELD

Read the Instructions for Use before using the Dupixent Pre-filled Syringe with needle shield. Do not inject yourself or someone else until you have been trained by a healthcare professional on how to prepare a dose and inject Dupixent. In adolescent 12 years of age and older, it is recommended that Dupixent be administered by or under the supervision of an adult. In children less than 12 years of age, Dupixent should be given by a caregiver.

This device is a **Single-use** Pre-filled Syringe (called “Syringe” in these instructions) with a needle shield. It contains 200 mg of Dupixent for injection under the skin (subcutaneous injection).

**Keep these instructions for future use. If you have any further questions, you should ask your healthcare provider or call 1 800 265-7927.**

The parts of the Dupixent syringe are shown in this picture.



### Important Information

- It is important that you do not try to give yourself or someone else the injection unless you have received training from your healthcare provider.
- Read all of the instructions carefully before using the Syringe.
- Ask your healthcare provider how often you will need to inject the medicine.
- Ask your healthcare provider to show you the right way to use the Syringe before you inject for the first time.
- Rotate the injection site each time you inject.
- To reduce the risk of accidental needle sticks, each pre-filled syringe has a needle shield that is automatically activated to cover the needle after you have given your injection
- **Do not** use the Syringe if it has been damaged.
- **Do not** use the Syringe if the Needle Cap is missing or not securely attached.
- **Do not** touch the Plunger Rod until you are ready to inject.
- **Do not** inject through clothes.
- **Do not** get rid of any air bubbles in the Syringe.
- **Do not** pull back on the Plunger Rod at any time.
- **Do not** re-use the Syringe.

### How to Store Dupixent:

- Keep the Syringe(s) out of the reach of children.
- Keep unused Syringes in the original carton and store in the refrigerator between 2°C and 8°C.
- Remove the Syringe from the refrigerator at least 30 minutes before your injection so that it reaches room temperature.
- **Do not** keep Dupixent at room temperature for more than 14 days.
- **Do not** shake the Syringe at any time.
- **Do not** heat the Syringe.
- **Do not** freeze the Syringe.
- **Do not** put the Syringe into direct sunlight.

### How to Dispose of (Throw Away) Used Syringes

Put your used Needles and Syringes in a-puncture-resistant container right away after use.



**Do not dispose of (throw away) the Syringes in your household trash.**

If you do not have a puncture-resistant container, you may use a household container that is:

- made of a heavy-duty plastic;

- can be closed with a tightfitting, puncture-resistant lid, without sharps being able to come out,
- upright and stable during use,
- leak-resistant, and
- properly labeled to warn of hazardous waste inside the container

When your puncture-resistant container is almost full, you will need to follow your provincial or local regulations for the correct way to dispose of it.

### **Step 1: Remove**

Remove the Syringe from the carton by holding the middle of the Syringe Body:



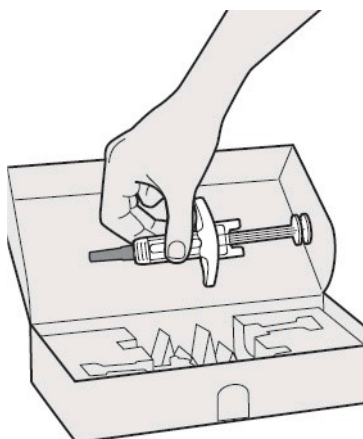
**Do not pull off the Needle Cap until you are ready to inject.**



**Do not use the Syringe if it has been dropped on a hard surface or damaged.**



**Do not keep Dupixent at room temperature for more than 14 days.**



### **Step 2: Prepare**

Ensure you have the following:

- the Dupixent Pre-filled Syringe with needle shield
- 1 alcohol wipe\*
- 1 cotton ball or gauze\*
- a puncture-resistant container\* (See Step 12)

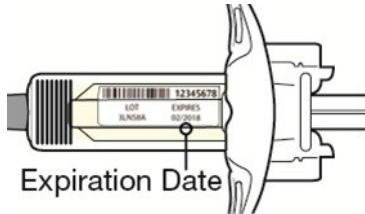
*\*Items not included in the carton*

Look at the label:

- Check the expiration date
- Check that you have the correct product and dose



**Do not use the Syringe if the expiration date has passed.**



### **Step 3: Inspect**

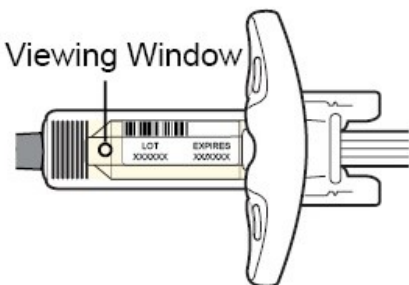
Look at the medicine through the viewing window on the Syringe:

Check if the liquid is clear and colorless to pale yellow.

*Note: You may see an air bubble; this is normal.*



**Do not use the Syringe if the liquid is discolored or cloudy, or if it contains visible flakes or particles.**



### **Step 4: Wait 30 minutes**

Lay the Syringe on a flat surface and let it naturally warm to room temperature for at least 30 minutes.



**Do not heat the Syringe.**

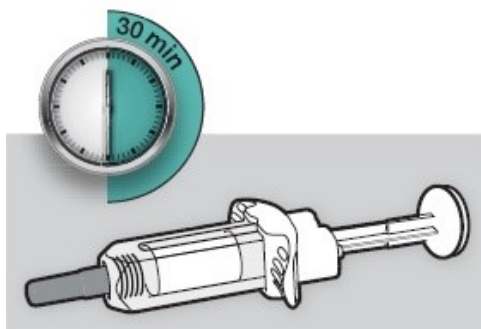


**Do not put the Syringe into direct sunlight.**



**Do not keep Dupixent at room temperature for more than 14 days.**





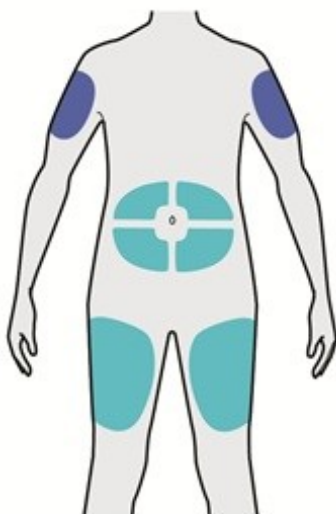
### **Step 5: Select**



Select the injection site.

- You can inject into your thigh or stomach, except for the 5 cm (2 inches) around your navel (belly-button)
- If somebody else gives you the injection, you can also use the upper arm.
- Change the injection site for each injection.



**Do not inject into skin that is tender, damaged or has bruises or scars.**



-  - Self-injection or by caregiver
-  - Injection by caregiver only

### **Step 6: Clean**

Wash your hands.

Clean the injection site with an alcohol wipe.

Let your skin dry before injecting.



**Do not touch the injection site again or blow on it before the injection.**



### **Step 7: Pull**

Hold the Syringe in the middle of the Syringe Body with the Needle pointing away from you and pull off the Needle Cap.



**Do not put the Needle Cap back on.**

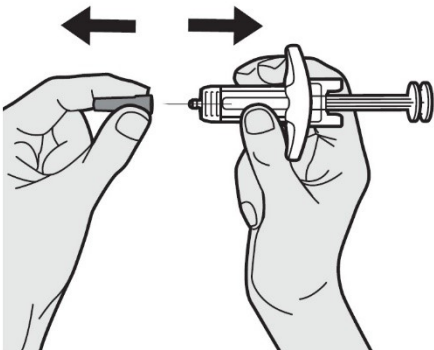


**Do not touch the Needle.**



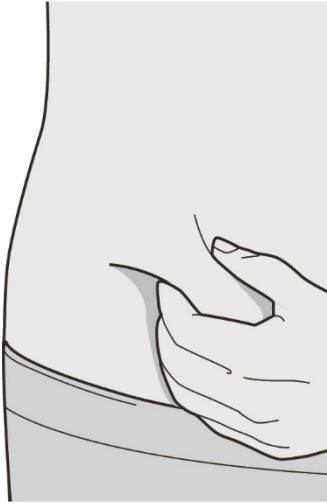
**Do not inject if the Needle is damaged**

Inject your medicine immediately after removing the Needle Cap.



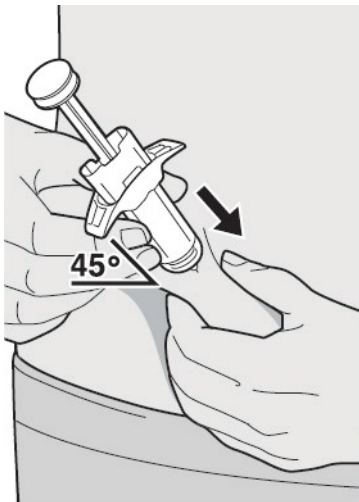
### **Step 8: Pinch**

Pinch a fold of skin at the injection site, as shown in the picture.



### **Step 9: Insert**

Insert the Needle completely into the fold of the skin at roughly a 45° angle.



### **Step 10: Push**

Relax the pinch.

Push the Plunger Rod down slowly and steadily as far as it will go until the Syringe is empty.

*Note: You will feel some resistance. This is normal.*



**Step 11: Release and Remove**

Lift your thumb to release the plunger rod until the needle is covered by the needle shield and then remove the syringe from the injection site.

Lightly press a cotton ball or gauze on the injection site if you see any blood.



**Do not put the Needle Cap back on.**



**Do not rub your skin after the injection.**



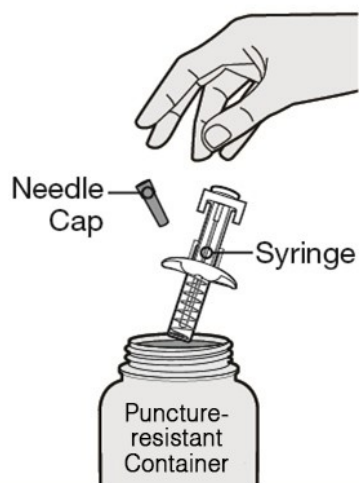
## **Step 12: Dispose**

Dispose of the Syringe and the Needle Cap in a puncture-resistant container.

 **Do not put the Needle Cap back on.**

Always keep the container out of the reach of children.

See “How to Dispose of (Throw Away) Used Syringes”.



## INSTRUCTIONS FOR USE

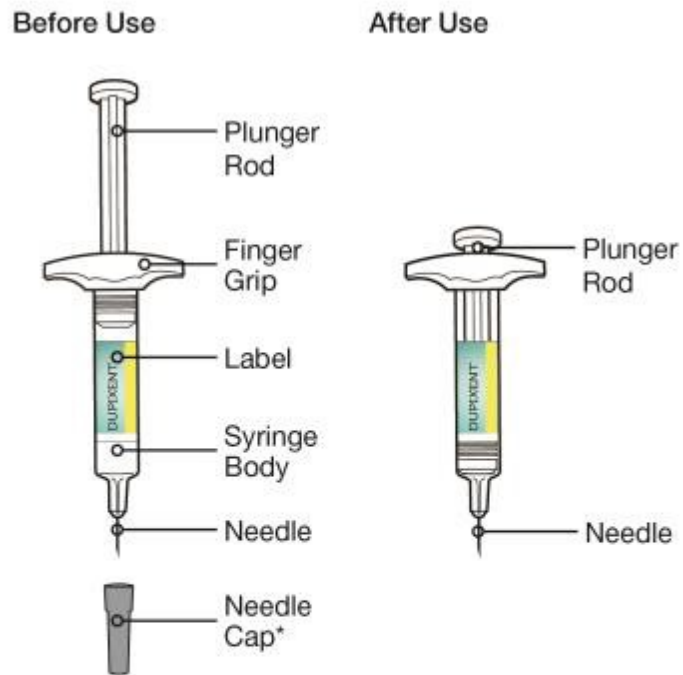
### DUPIXENT 300 MG SINGLE-USE PRE-FILLED SYRINGE

Read the Instructions for Use before using the Dupixent Pre-filled Syringe with needle shield. Do not inject yourself or someone else until you have been trained by a healthcare professional on how to prepare a dose and inject Dupixent. In adolescent 12 years of age and older, it is recommended that Dupixent be administered by or under the supervision of an adult. In children less than 12 years of age, Dupixent should be given by a caregiver.

This device is a **Single-use** Pre-filled Syringe (called “Syringe” in these instructions). It contains 300 mg of Dupixent for injection under the skin (subcutaneous injection).

**Keep these instructions for future use. If you have any further questions, you should ask your healthcare provider or call 1 800 265-7927.**

The parts of the Dupixent syringe are shown in this picture.



\*The device may have either a soft or hard Needle Cap.

### Important Information

- It is important that you do not try to give yourself or someone else the injection unless you have received training from your healthcare provider.
- Read all of the instructions carefully before using the Syringe.
- Ask your healthcare provider how often you will need to inject the medicine.
- Ask your healthcare provider to show you the right way to use the Syringe before you inject for the first time.
- Rotate the injection site each time you inject.
- **Do not** use the Syringe if it has been damaged.
- **Do not** use the Syringe if the Needle Cap is missing or not securely attached.
- **Do not** touch the Plunger Rod until you are ready to inject.
- **Do not** inject through clothes.
- **Do not** get rid of any air bubbles in the Syringe.
- **Do not** pull back on the Plunger Rod at any time.
- **Do not** re-use the Syringe.

### How to Store Dupixent:

- Keep the Syringe(s) out of the reach of children.
- Keep unused Syringes in the original carton and store in the refrigerator between 2°C and 8°C.
- Remove the Syringe from the refrigerator at least 45 minutes before your injection so that it reaches room temperature.
- **Do not** keep Dupixent at room temperature for more than 14 days.
- **Do not** shake the Syringe at any time.
- **Do not** heat the Syringe.
- **Do not** freeze the Syringe.
- **Do not** put the Syringe into direct sunlight.

### How to Dispose of (Throw Away) Used Syringes

Put your used Needles and Syringes in a-puncture-resistant container right away after use.



**Do not dispose of (throw away) the Syringes in your household trash.**

If you do not have a puncture-resistant container, you may use a household container that is:




- made of a heavy-duty plastic;
- can be closed with a tightfitting, puncture-resistant lid, without sharps being able to come out,
- upright and stable during use,
- leak-resistant, and
- properly labeled to warn of hazardous waste inside the container



When your puncture-resistant container is almost full, you will need to follow your provincial or local regulations for the correct way to dispose of it.

### **Step 1: Remove**

Remove the Syringe from the carton by holding the middle of the Syringe Body:

-  **Do not pull off the Needle Cap until you are ready to inject.**
-  **Do not use the Syringe if it has been damaged.**
-  **Do not keep Dupixent at room temperature for more than 14 days**



### **Step 2: Prepare**

Ensure you have the following:

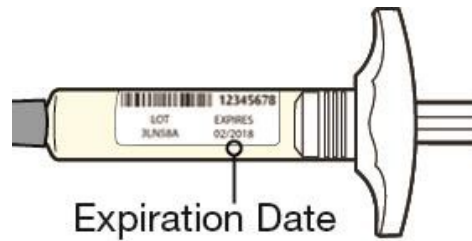
- the Dupixent Pre-filled Syringe with needle shield
- 1 alcohol wipe\*
- 1 cotton ball or gauze\*
- a puncture-resistant container\* (See Step 12)

*\*Items not included in the carton*

Look at the label:

- Check the expiration date
- Check that you have the correct product and dose

 **Do not use the Syringe if the expiration date has passed.**



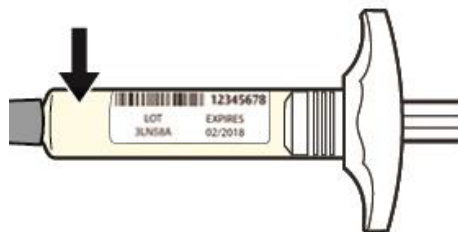
### **Step 3: Inspect**

Look at the medicine in the Syringe:

Check if the liquid is clear and colorless to pale yellow.

*Note: You may see an air bubble; this is normal.*

 **Do not use the Syringe if the liquid is discolored or cloudy, or if it contains visible flakes or particles.**



### **Step 4: Wait 45 minutes**

Lay the Syringe on a flat surface and let it naturally warm to room temperature for at least 45 minutes.



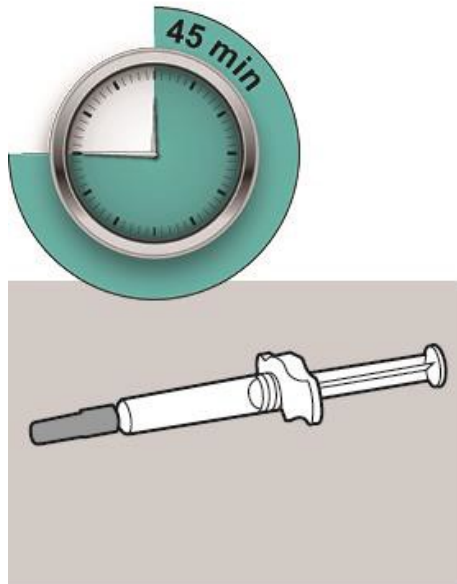
**Do not heat the Syringe.**



**Do not put the Syringe into direct sunlight.**



**Do not keep Dupixent at room temperature for more than 14 days.**



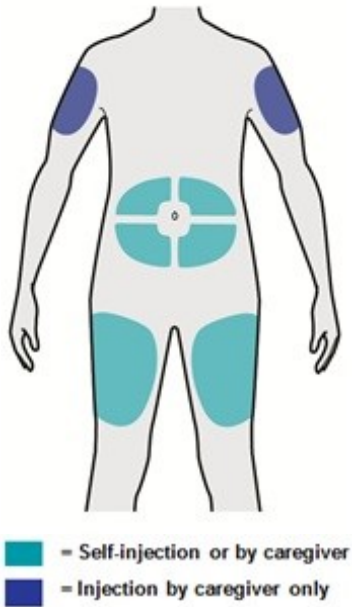
### **Step 5: Select**

Select the injection site.

- You can inject into your thigh or stomach, except for the 5 cm (2 inches) around your navel (belly-button).
- If somebody else gives you the injection, you can also use the upper arm.
- Change the injection site for each injection.



**Do not inject into skin that is tender, damaged or has bruises or scars.**



### **Step 6: Clean**

Wash your hands.

Clean the injection site with an alcohol wipe.

Let your skin dry before injecting.

 **Do not touch the injection site again or blow on it before the injection.**



### **Step 7: Pull**

Hold the Syringe in the middle of the Syringe Body with the Needle pointing away from you and pull off the Needle Cap.



**Do not put the Needle Cap back on.**

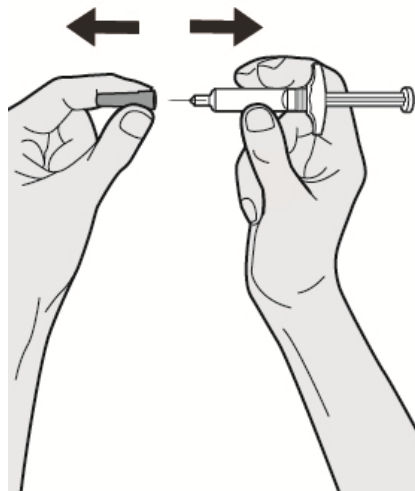


**Do not touch the Needle.**



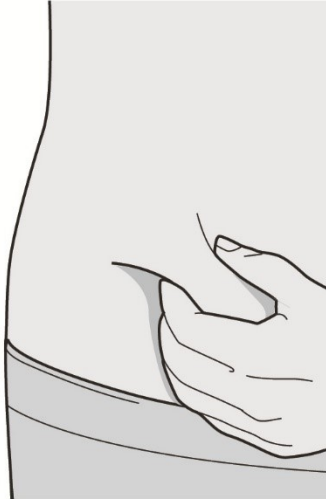
**Do not inject if the Needle is damaged**

Inject your medicine immediately after removing the Needle Cap.



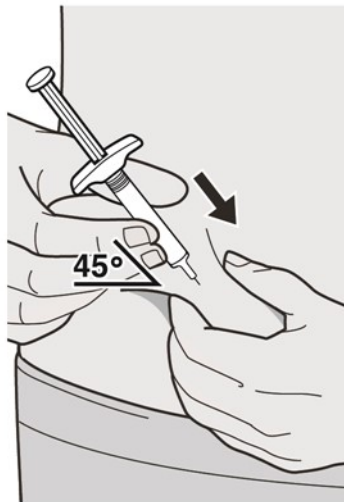
### **Step 8: Pinch**

Pinch a fold of skin at the injection site, as shown in the picture.



### **Step 9: Insert**

Insert the Needle into the fold of the skin at roughly a 45° angle.



### **Step 10: Push**

Relax the pinch.

Push the Plunger Rod down slowly and steadily as far as it will go until the Syringe is empty.

*Note: You will feel some resistance. This is normal.*




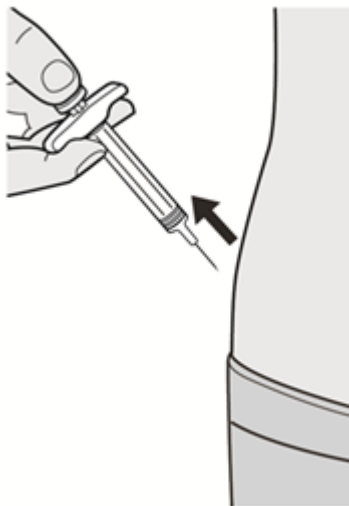
### **Step 11: Remove**

Pull the Needle out of the skin at the same angle it was inserted.

 **Do not put the Needle Cap back on.**

Lightly press a cotton ball or gauze on the injection site if you see any blood.

 **Do not rub your skin after the injection.**



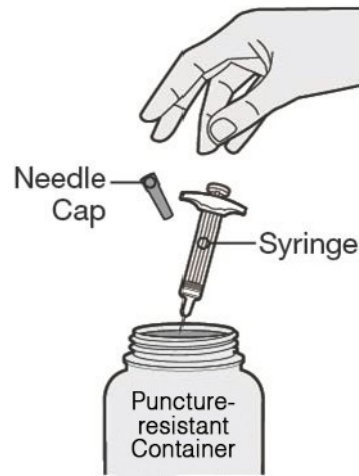
### **Step 12: Dispose**

Dispose of the Syringe and the Needle Cap in a puncture-resistant container.

 **Do not put the Needle Cap back on.**

Always keep the container out of the reach of children.

See “How to Dispose of (Throw Away) Used Syringes”.





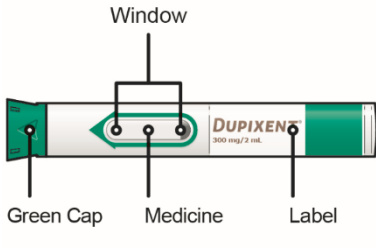
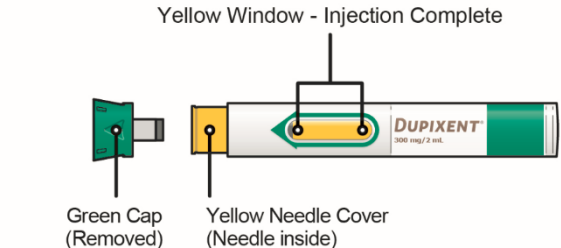
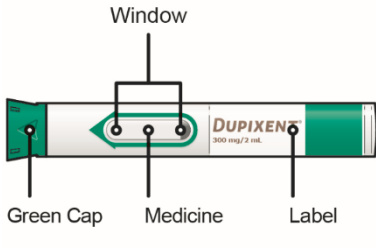
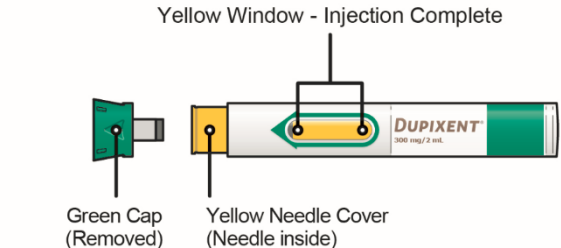
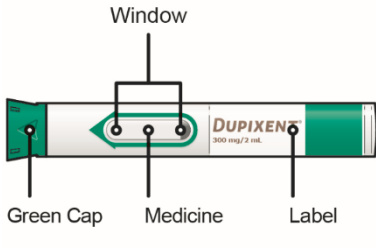
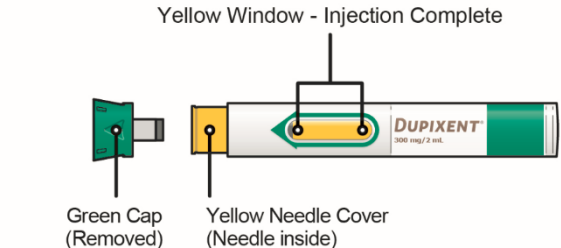
## INSTRUCTIONS FOR USE

### DUPIXENT 300 MG SINGLE-USE PRE-FILLED PEN

Read the 'Instructions for Use' before using the Dupixent Pre-filled Pen. Do not inject yourself or someone else until you have been trained by a healthcare professional on how to prepare a dose and inject Dupixent. The Dupixent pre-filled pen is only for use in adults, adolescents and pediatrics patients aged 2 years of age and older. In children less than 12 years of age, Dupixent should be given by a caregiver. In adolescents 12 years of age and older, it is recommended that Dupixent be administered by, or under supervision of, an adult.

This device is a Single-use Pre-filled Pen. It contains 300 mg of Dupixent for injection under the skin (subcutaneous injection).

**Keep these instructions for future use. If you have any further questions, you should ask your healthcare professional or call 1 800 265-7927.**

<p>The parts of the Dupixent Pre-filled Pen are shown in this picture.</p>	<table border="0"><thead><tr><th data-bbox="448 800 829 831"><b>Before Injection</b></th><th data-bbox="829 800 1404 831"><b>After Injection</b></th></tr></thead><tbody><tr><td data-bbox="448 831 829 1108"><p>Window</p><p>Green Cap</p><p>Medicine</p><p>Label</p></td><td data-bbox="829 831 1404 1108"><p>Yellow Window - Injection Complete</p><p>Green Cap (Removed)</p><p>Yellow Needle Cover (Needle inside)</p></td></tr></tbody></table>	<b>Before Injection</b>	<b>After Injection</b>	 <p>Window</p> <p>Green Cap</p> <p>Medicine</p> <p>Label</p>	 <p>Yellow Window - Injection Complete</p> <p>Green Cap (Removed)</p> <p>Yellow Needle Cover (Needle inside)</p>
<b>Before Injection</b>	<b>After Injection</b>				
 <p>Window</p> <p>Green Cap</p> <p>Medicine</p> <p>Label</p>	 <p>Yellow Window - Injection Complete</p> <p>Green Cap (Removed)</p> <p>Yellow Needle Cover (Needle inside)</p>				
<p><b>Important Information:</b></p> <ul style="list-style-type: none"><li>• Read all of the instructions carefully before using the Pre-filled Pen.</li><li>• Ask your healthcare professional how often you need to inject the medicine.</li><li>• In children 12 years of age and older, it is recommended that Dupixent be administered by or under supervision of an adult.</li><li>• In children 2 years to less than 12 years of age, Dupixent should be given by a caregiver.</li><li>• Choose a different injection site for each injection.</li><li>• <b>Do not</b> use the Pre-filled Pen if it has been damaged.</li><li>• <b>Do not</b> use the Pre-filled Pen if the Green Cap is missing or not securely attached.</li><li>• <b>Do not</b> press or touch the Yellow Needle Cover with your fingers.</li><li>• <b>Do not</b> inject through clothes.</li><li>• <b>Do not</b> remove the Green Cap until just before you give the injection.</li><li>• <b>Do not</b> try to put the Green Cap back on the Pre-filled Pen.</li><li>• Throw away (dispose of) the Pre-filled Pen right away after use. See "Step D: Dispose" below.</li></ul> <p><b>Do not</b> re-use a Pre-filled Pen.</p>					
<p><b>How should I store Dupixent?</b></p> <ul style="list-style-type: none"><li>• Keep the Pre-filled Pen(s) and all medicines out of the reach and sight of children.</li><li>• Store unused Pre-filled Pens in the refrigerator between 2°C and 8°C (36°F and 46°F).</li><li>• Store Pre-filled Pens in the original carton to protect it from light.</li></ul>					

- **Do not** keep Pre-filled Pens at room temperature (less than 25°C (77°F)) for more than 14 days. Throw away (dispose) any Pre-filled Pens that have been left at room temperature for more than 14 days.
- **Do not** shake the Pre-filled Pen.
- **Do not** heat the Pre-filled Pen.
- **Do not** freeze the Pre-filled Pen.
- **Do not** put the Pre-filled Pen into direct sunlight.

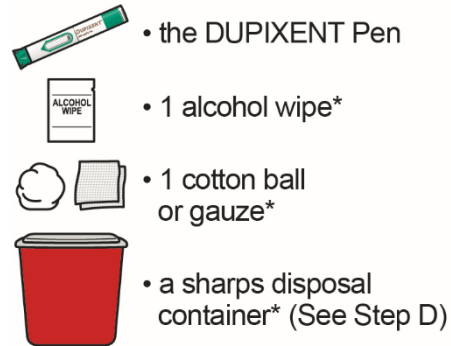
## A: Prepare

### A1. Gather supplies

Ensure you have the following:

- the Dupixent Pre-filled Pen
- 1 alcohol wipe\*
- 1 cotton ball or gauze\*
- a sharps (puncture resistant) disposal container\* (See Step D)

\* Items not included in the carton



\* Items not included in the carton.

### A2. Look at the Label

- Confirm that you have the correct product and dose.

#### Look at the Label



### A3. Check Expiration Date

- Check the expiration date.

**⚠ Do not use the Pre-filled Pen if the expiration date has passed.**

#### Expiration Date





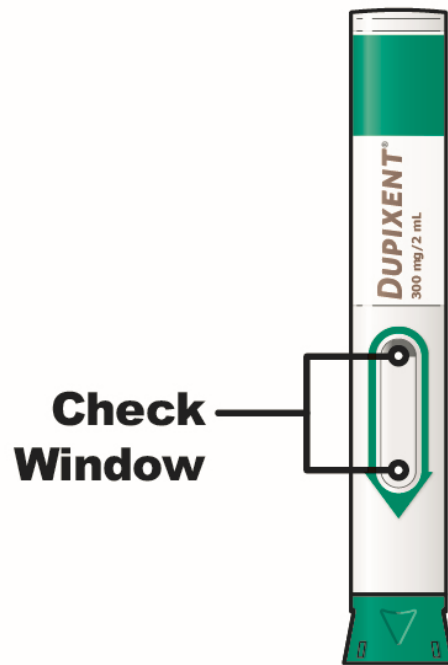
#### A4. Check the Medicine

Look at the medicine through the window on the Pre-filled Pen:

Check to ensure the liquid is clear and colorless to pale yellow.




*Note: You may see an air bubble; this is normal.*

-  **Do not use the Pre-filled Pen if the liquid is discolored or cloudy, or if it contains visible flakes or particles.**
-  **Do not use the Pre-filled Pen if the window is yellow.**



## A5: Wait 45 minutes

Place the Pre-filled Pen on a flat surface and allow it to warm to room temperature (less than 25°C (77°F)) for at least 45 minutes.

-  **Do not heat the Pre-filled Pen.**
-  **Do not put the Pre-filled Pen into direct sunlight.**
-  **Do not keep Dupixent at room temperature for more than 14 days. Dispose (throw away) any Dupixent Pens that have been left at room temperature for longer than 14 days.**




## B. Choose your injection site

### B1. Recommended injection sites are:

- **Thigh**
- **Stomach** except for the 5 cm (2 inches) around your belly button (navel).
- **Upper Arm** If a caregiver gives your dose, they can also use the outer area of the upper arm.



Choose a different injection site for each Dupixent injection. If you need a second injection to complete your dose then leave at least 5 cm (2 inches) between the two injection sites.

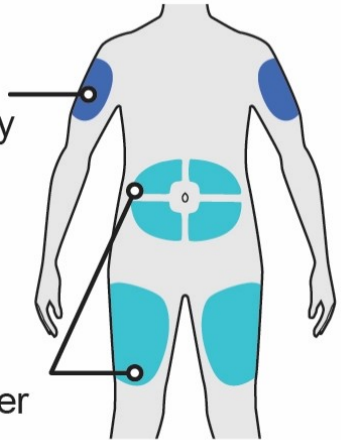
 **Do not inject through clothes.**

 **Do not inject into skin that is tender, damaged, bruised or scarred.**

Injection by caregiver only

Self-injection or by caregiver

 Self-injection or by caregiver  
 Injection by caregiver only



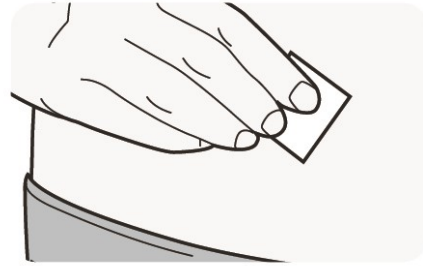
### B2. Wash Your Hands



### B3. Prepare the injection site

- Clean the injection site with an alcohol wipe.
- Let your skin dry before injecting.

**⚠ Do not touch the injection site again or blow on it before the injection.**



## C. Give injection

### C1. Remove Green Cap

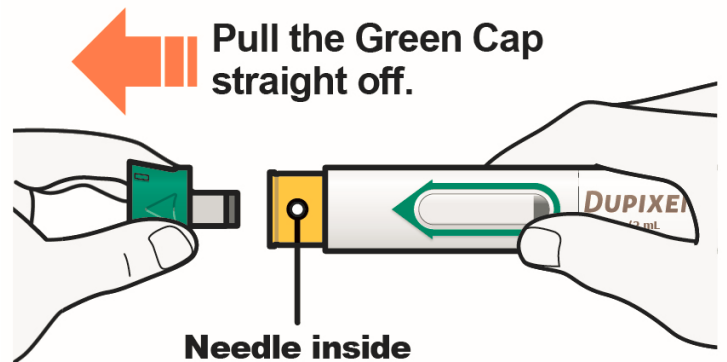
Pull the Green Cap straight off.

**Do not** twist the Green Cap off.

**Do not** remove the Green Cap until you are ready to inject.

**⚠ Do not press or touch the Yellow Needle Cover with your fingers. The Needle is inside.**

**⚠ Do not put the Green Cap back on the Pre-filled Pen after you have removed it.**




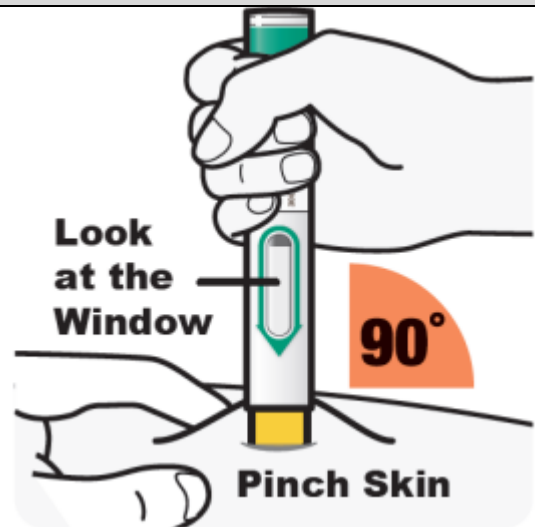
## C2. Pinch Skin and Place

For pediatrics patients 2 years to less than 12 years of age, pinch the skin before and during the injection.

Pinching of the skin is not needed for adults and adolescent patients aged 12 years of age and older.

- When placing the Yellow Needle Cover on your skin, hold the Pre-filled Pen so that you can see the Window.
- Place the Yellow Needle Cover on your skin at approximately a 90-degree angle.

 **Do not press or touch the Yellow Needle Cover with your fingers; the Needle is inside.**



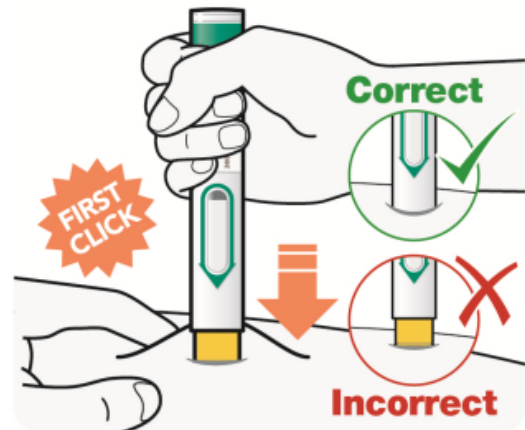
## C3. Press down

Press and hold the Pre-filled Pen firmly against your skin until you cannot see the Yellow Needle Cover.

- There will be a “click” when the injection starts.
- The window will start to turn yellow.

The injection can take up to 20 seconds.

Pinching of the skin is not needed for adults and children aged 12 years and older.




#### C4. Hold firmly

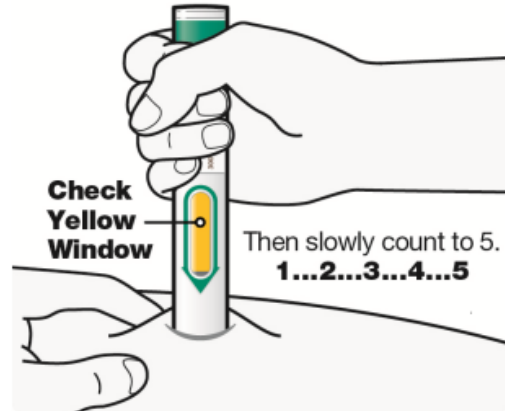
Keep holding the Pre-filled Pen firmly against your skin.

- You may hear a second click.
- Check that the entire window has turned to yellow.
- Then slowly count to 5.
- Then lift the pen up off the skin, your injection is complete.

If the window does not turn completely yellow, remove the pen and call your healthcare professional.

 **Do not give yourself a second dose unless instructed by your healthcare professional.**

Pinching of the skin is not needed for adults and children aged 12 years and older.

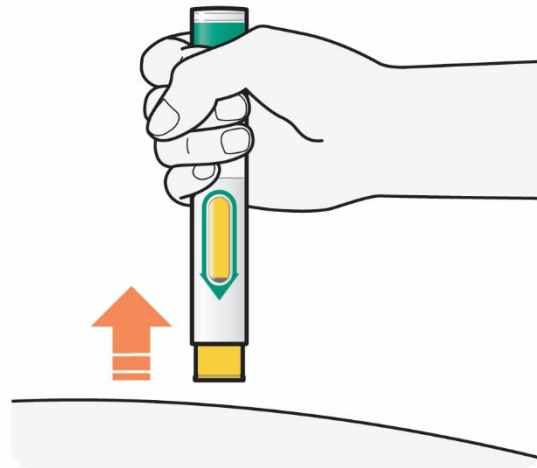




## C5. Remove

- After you have completed your injection, pull straight up to remove Pre-filled Pen from the skin.
- If you see any blood at the site, lightly dab the site with a clean cotton ball or gauze pad.

 **Do not rub your skin after the injection.**



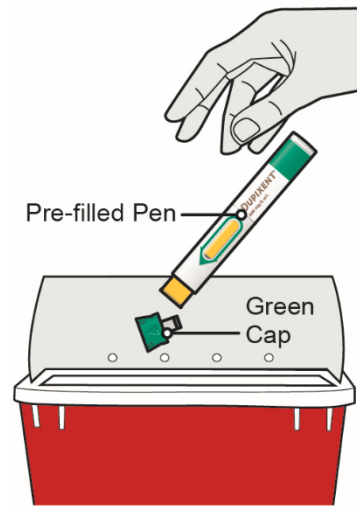
## D. Dispose

- Dispose (throw away) your used Dupixent Pre-filled Pens, (Needle inside), and Green Caps in a puncture resistant (sharps disposal) container right away after use.

**Do not** dispose (throw away) the used Pre-filled Pens (Needle inside) or Green Caps in your household trash.



**Do not put the Green Cap back on the Pre-filled Pens.**



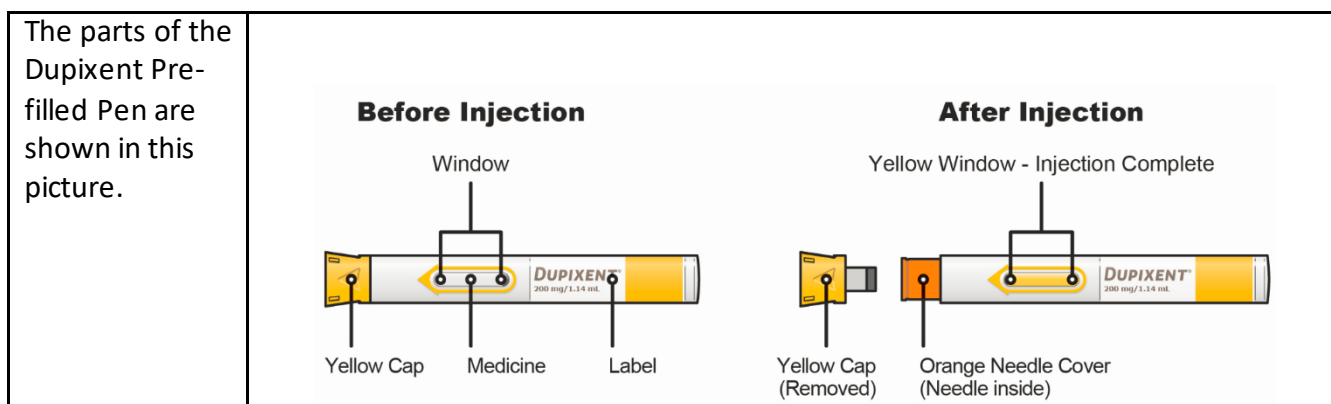
## INSTRUCTIONS FOR USE

### DUPIXENT 200 MG SINGLE-USE PRE-FILLED PEN

Read the 'Instructions for Use' before using the Dupixent Pre-filled Pen. Do not inject yourself or someone else until you have been trained by a healthcare professional on how to prepare a dose and inject Dupixent. The Dupixent pre-filled pen is only for use in adults, adolescents and pediatrics patients aged 2 years of age and older. In children less than 12 years of age, Dupixent should be given by a caregiver. In adolescent pediatrics patients 12 years of age and older, it is recommended that Dupixent be administered by, or under supervision of, an adult.

This device is a Single-use Pre-filled Pen. It contains 200 mg of Dupixent for injection under the skin (subcutaneous injection).

**Keep these instructions for future use. If you have any further questions, you should ask your healthcare professional or call 1 800 265-7927.**



## Important Information

- Read all of the instructions carefully before using the Pre-filled Pen.
- Ask your healthcare provider how often you will need to inject the medicine.
- In children 12 years of age and older, it is recommended that Dupixent be administered by or under supervision of an adult.
- In children 2 years to less than 12 years of age, Dupixent should be given by a caregiver.
- Choose a different injection site for each injection.
- **Do not** use the Pre-filled Pen if it has been damaged.
- **Do not** use the Pre-filled Pen if the Yellow Cap is missing or not securely attached.
- **Do not** press or touch the Orange Needle Cover with your fingers.
- **Do not** inject through clothes.
- **Do not** remove the Yellow Cap until just before you give the injection.
- **Do not** try to put the Yellow Cap back on the Pre-filled Pen.
- Throw away (dispose of) the Pre-filled Pen right away after use. See “Step D: Dispose” below.
- **Do not** re-use a Pre-filled Pen.

## How should I store Dupixent

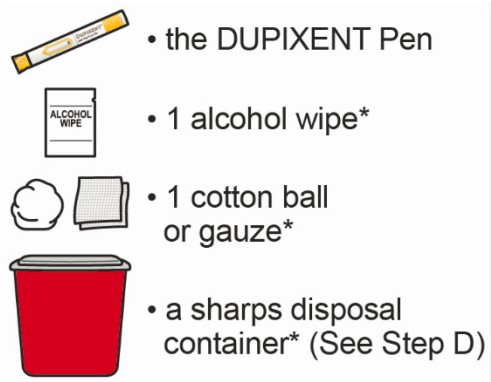
- Keep the Pre-filled Pen(s) and all medicines out of the reach of children.
- Store unused Pre-filled Pens in the refrigerator between 36°F and 46°F (2°C and 8°C).
- Store Pre-filled Pens in the original carton to protect it from light.
- **Do not** keep Pre-filled Pens at room temperature (less than 77°F or less than 25°C) for more than 14 days. Throw away (dispose of) any Pre-filled Pens that have been left at room temperature for more than 14 days.
- **Do not** shake the Pre-filled Pen at any time.
- **Do not** heat the Pre-filled Pen.
- **Do not** freeze the Pre-filled Pen.
- **Do not** put the Pre-filled Pen into direct sunlight.

**A: Prepare**

**A1. Gather supplies**

Ensure you have the following:

- the Dupixent Pre-filled Pen
- 1 alcohol wipe\*
- 1 cotton ball or gauze\*
- a sharps (puncture resistant) disposal container\* (See Step D)



\* Items not included in the carton.

\* Items not included in the carton

**A2. Look at the Label**


- Confirm that you have the correct product and dose.

**Look at the Label**



**A3. Check Expiration Date**

- Check the expiration date.

 **Do not use the Pre-filled Pen if the expiration date has passed.**

**Expiration Date**



#### A4. Check the Medicine

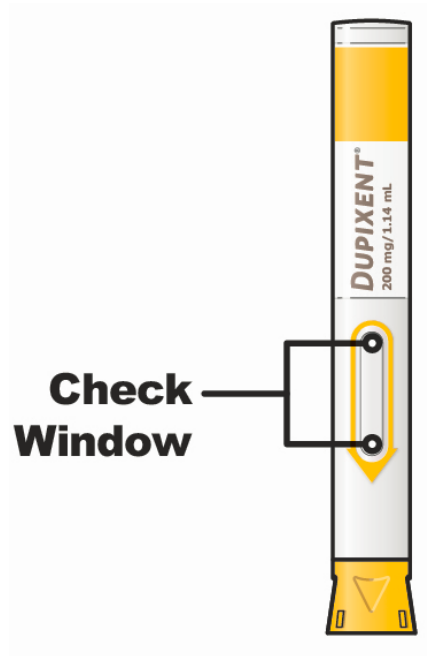
Look at the medicine through the Window on the Pre-filled Pen:

Check if the liquid is clear and colorless to pale yellow.

*Note: You may see an air bubble; this is normal.*




**⚠ Do not use the Pre-filled Pen if the liquid is discolored or cloudy, or if it contains visible flakes or particles.**

**⚠ Do not use the Pre-filled Pen if the Window is Yellow.**



## A5: Wait 30 minutes

Lay the Pre-filled Pen on a flat surface and let it naturally warm up at room temperature (less than 77°F or less than 25°C) for at least 30 minutes.

-  **Do not heat the Pre-filled Pen.**
-  **Do not put the Pre-filled Pen into direct sunlight.**
-  **Do not keep Dupixent at room temperature for more than 14 days. Dispose of (throw away) any Dupixent Pens that have been left at room temperature for longer than 14 days.**





## B. Choose your injection site

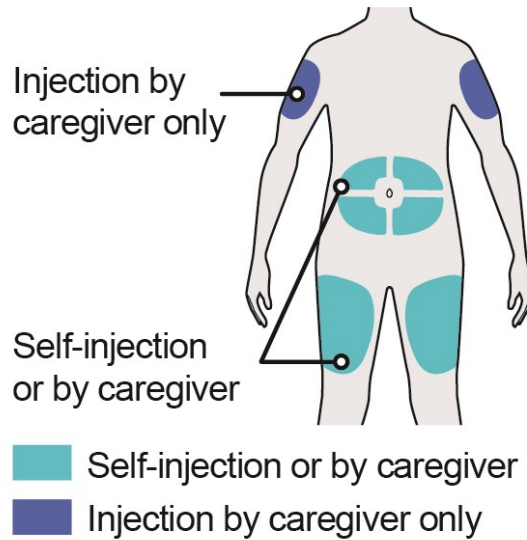
### B1. Recommended injection sites are:

- **Thigh**
- **Abdomen** except for the 2 inches (5 cm) around your belly button (navel).
- **Upper Arm** If a caregiver gives your dose, they can also use the outer area of the upper arm.

Choose a different injection site for each Dupixent injection.

 **Do not inject through clothes.**

 **Do not inject into skin that is tender, damaged, bruised or scarred.**



### B2. Wash Your Hands

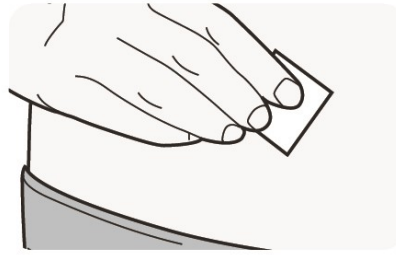




### B3. Prepare the injection site

- Clean the injection site with an alcohol wipe.
- Let your skin dry before injecting.

**⚠ Do not touch the injection site again or blow on it before the injection.**



### C. Give injection

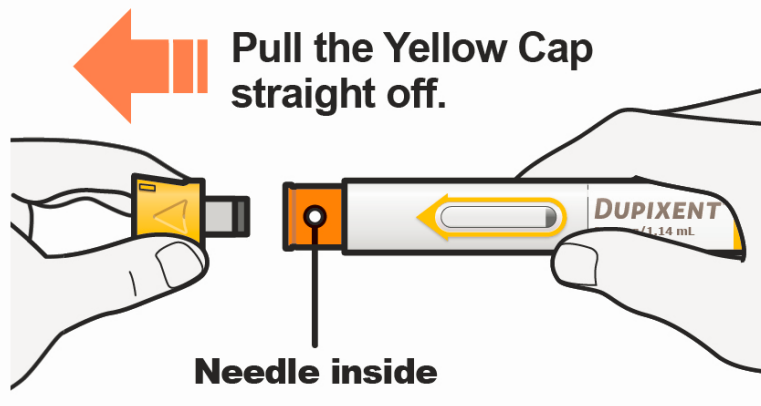
#### C1. Remove Yellow Cap

**Do not** twist the Yellow Cap off.

**Do not** remove the Yellow Cap until you are ready to inject.

**Do not** press or touch the Orange Needle Cover with your fingers. The Needle is inside.

**⚠ Do not** put the Yellow Cap back on the Pre-filled Pen after you have removed it.



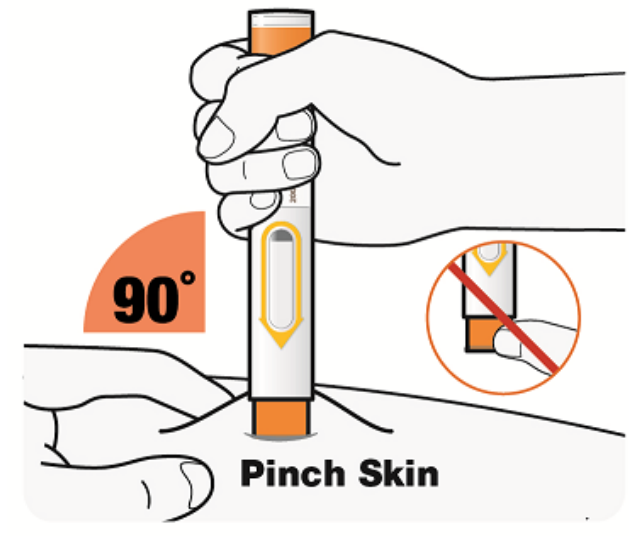
## C2. Pinch Skin and Place

For pediatric patients 2 years of age to less than 12 years of age, pinch the skin before and during the injection.

Pinching of the skin is not needed for adults and adolescent patients aged 12 years of age and older.

- When placing the Orange Needle Cover on your skin, hold the Pre-filled Pen so that you can see the Window.
- Place the Orange Needle Cover on your skin at approximately a 90-degree angle.

**⚠ Do not press or touch the Orange Needle Cover with your fingers. The Needle is inside.**



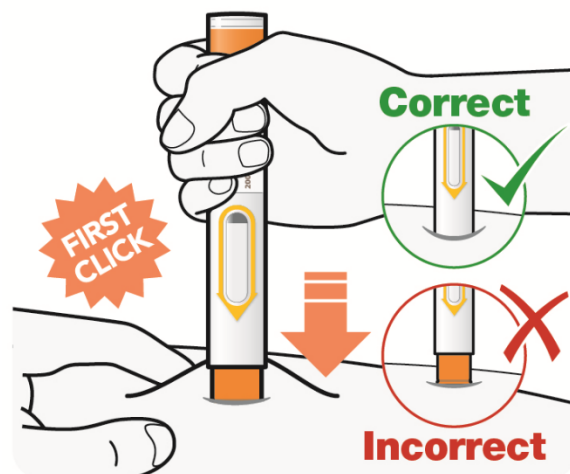
## C3. Press down

Press the Pre-filled Pen firmly against your skin until you cannot see the Orange Needle Cover, and hold.

- There will be a “click” when the injection starts.
- The window will start to turn Yellow.

The injection can take up to 20 seconds.

Pinching of skin is not needed for adults and children aged 12 years and older.



## C4. Hold firmly

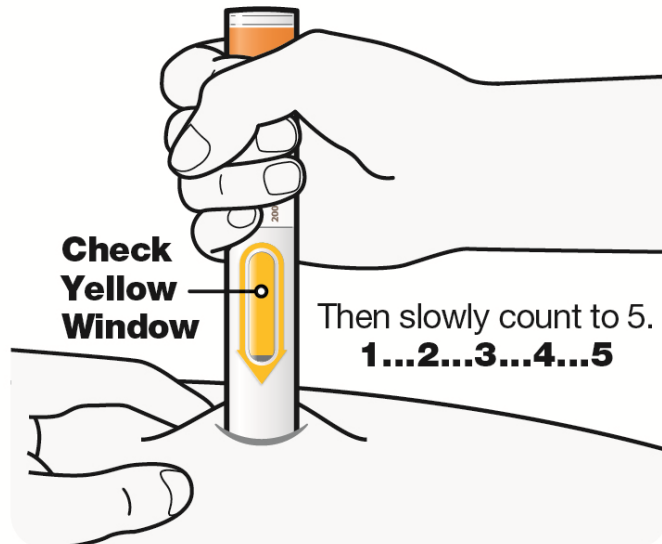
Keep holding the Pre-filled Pen firmly against your skin.

- You may hear a second click.
- Check that the entire Window has turned to Yellow.
- Then slowly count to 5.
- Then lift the pen up off the skin, your injection is complete.

If the Window does not turn completely Yellow, remove the pen and call your healthcare provider.


**⚠ Do not give yourself a second dose without speaking to your healthcare provider.**

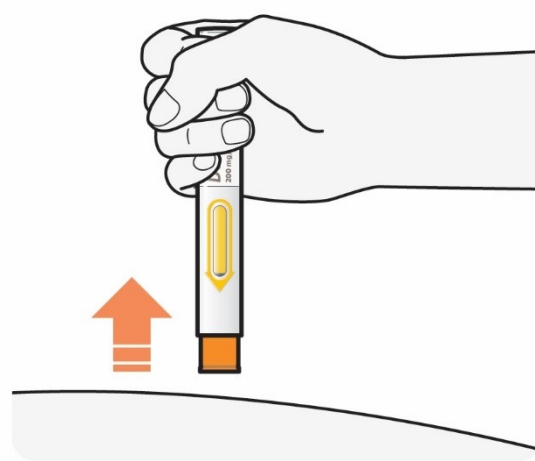
Pinching of skin is not needed for adults and children aged 12 years and older.



### C5. Remove

- After you have completed your injection pull straight up to remove Pre-filled Pen from the skin.
- If you see any blood at the site, lightly dab a cotton ball or gauze pad.

 **Do not rub your skin after the injection.**



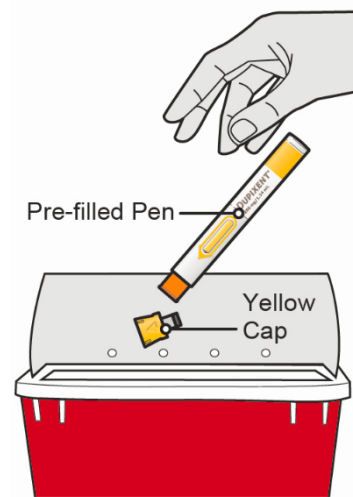
## D. Dispose

- Dispose of (throw away) your used Dupixent Pre-filled Pens, (Needle inside), and Yellow Caps in a puncture resistant (sharps disposal) container right away after use.

**Do not** dispose of (throw away) the used Pre-filled Pens (Needle inside), and Yellow Caps in your household trash.



**Do not put the Yellow Cap back on.**



## DUPIXENT (dupilumab injection) 200 mg Pre-filled Pen

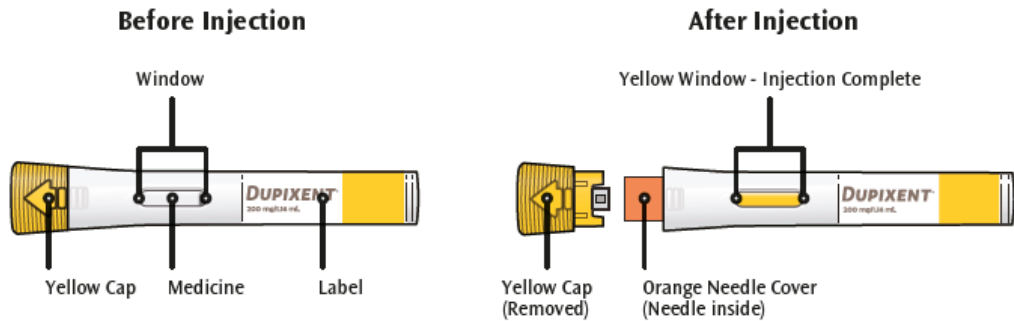
### Instructions for Use

Read the Instructions for Use before using the DUPIXENT Pre-filled Pen. Do not inject yourself or someone else until you have been shown how to inject DUPIXENT. Your healthcare provider can show you or your caregiver how to prepare and inject a dose of DUPIXENT before you try to do it yourself for the first time. The DUPIXENT Pre-filled Pen is only for use in adult, adolescent and pediatric patients aged 2 years of age and older. In children less than 12 years of age, Dupixent should be given by a caregiver. In adolescents 12 years of age and older, it is recommended that Dupixent be administered by or under supervision of an adult.

This device is a Single-use Pre-filled Pen. It contains 200 mg of DUPIXENT for injection under the skin (subcutaneous injection).

**Keep these instructions for future use. If you have any further questions, you should ask your healthcare professional or call 1 800 265-7927.**

The parts of the DUPIXENT Pre-filled Pen are shown in this picture.



## Important Information

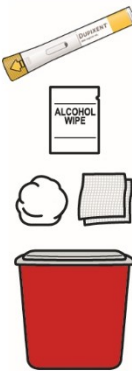


- Read all of the instructions carefully before using the Pre-filled Pen.
- Ask your healthcare provider how often you will need to inject the medicine.
- In children 12 years of age and older, it is recommended that Dupixent be administered by or under supervision of an adult.
- In children 2 years to less than 12 years of age, Dupixent should be given by a caregiver.
- Choose a different injection site for each injection.
- **Do not** use the Pre-filled Pen if it has been damaged.
- **Do not** use the Pre-filled Pen if the Yellow Cap is missing or not securely attached.
- **Do not** press or touch the Orange Needle Cover with your fingers.
- **Do not** inject through clothes.
- **Do not** remove the Yellow Cap until just before you give the injection.
- **Do not** try to put the Yellow Cap back on the Pre-filled Pen.
- Throw away (dispose of) the Pre-filled Pen right away after use. See “Step D: Dispose” below.
- **Do not** re-use a Pre-filled Pen.

## How should I store DUPIXENT

- Keep the Pre-filled Pen(s) and all medicines out of the reach of children.
- Store unused Pre-filled Pens in the refrigerator between 2°C and 8°C (36°F and 46°F).
- Store Pre-filled Pens in the original carton to protect it from light.
- **Do not** keep Pre-filled Pens at room temperature (less than 25°C or less than 77°F) for more than 14 days. Throw away (dispose of) any Pre-filled Pens that have been left at room temperature for more than 14 days.
- **Do not** shake the Pre-filled Pen at any time.
- **Do not** heat the Pre-filled Pen.
- **Do not** freeze the Pre-filled Pen.
- **Do not** put the Pre-filled Pen into direct sunlight.

## A: Prepare

### A1. Gather supplies

<p>Ensure you have the following:</p> <ul style="list-style-type: none"> <li>• the DUPIXENT Pre-filled Pen</li> <li>• 1 alcohol wipe*</li> <li>• 1 cotton ball or gauze*</li> <li>• a sharps (puncture resistant) disposal container* (See Step D)</li> </ul> <p><i>* Items not included in the carton</i></p>	 <ul style="list-style-type: none"> <li>• the DUPIXENT Pen</li> <li>• 1 alcohol wipe*</li> <li>• 1 cotton ball or gauze*</li> <li>• a sharps disposal container* (See Step D)</li> </ul> <p><i>* Items not included in the carton.</i></p>
<p><b>A2. Look at the Label</b></p>	
<ul style="list-style-type: none"> <li>• Confirm that you have the correct product and dose.</li> </ul>	<p style="text-align: center;"><b>Look at the Label</b></p> 
<p><b>A3. Check Expiration Date</b></p>	
<ul style="list-style-type: none"> <li>• Check the expiration date.</li> </ul> <p><b>⚠ Do not use the Pre-filled Pen if the expiration date has passed.</b></p>	<p style="text-align: center;"><b>Expiration Date</b></p> 
<p><b>A4. Check the Medicine</b></p>	

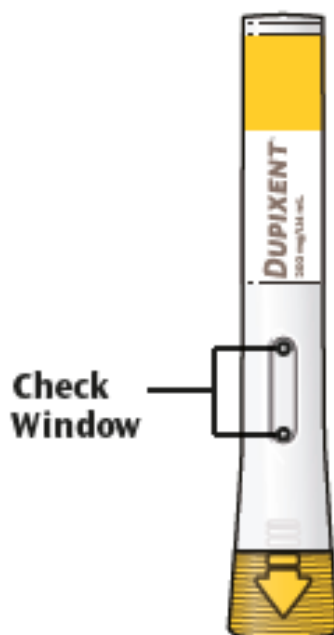
Look at the medicine through the Window on the Pre-filled Pen:

Check if the liquid is clear and colorless to pale yellow.

*Note: You may see an air bubble; this is normal.*

**⚠ Do not use the Pre-filled Pen if the liquid is discolored or cloudy, or if it contains visible flakes or particles.**




**⚠ Do not use the Pre-filled Pen if the Window is Yellow.**





## A5: Wait 30 minutes

Lay the Pre-filled Pen on a flat surface and let it naturally warm up at room temperature (less than 25°C or less than 77°F) for at least 30 minutes.

-  **Do not heat the Pre-filled Pen.**
-  **Do not put the Pre-filled Pen into direct sunlight.**
-  **Do not keep DUPIXENT at room temperature for more than 14 days. Dispose of (throw away) any DUPIXENT Pens that have been left at room temperature for longer than 14 days.**





## B. Choose your injection site

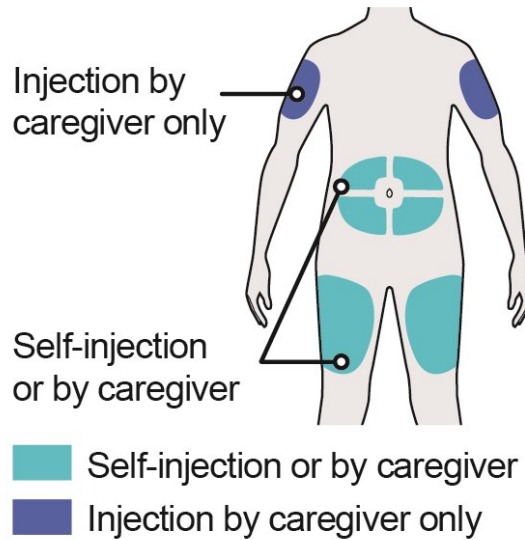
### B1. Recommended injection sites are:

- **Thigh**
- **Abdomen** except for the 2 inches (5 cm) around your belly button (navel).
- **Upper Arm** If a caregiver gives your dose, they can also use the outer area of the upper arm.

Choose a different injection site for each DUPIXENT injection.

 **Do not inject through clothes.**

 **Do not inject into skin that is tender, damaged, bruised or scarred.**



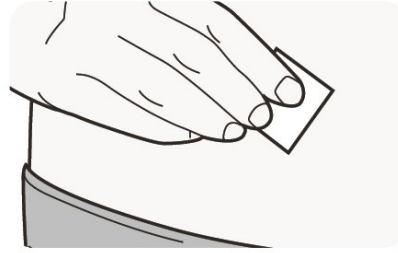
### B2. Wash Your Hands



### B3. Prepare the injection site

- Clean the injection site with an alcohol wipe.
- Let your skin dry before injecting.

**⚠ Do not touch the injection site again or blow on it before the injection.**



## C. Give injection

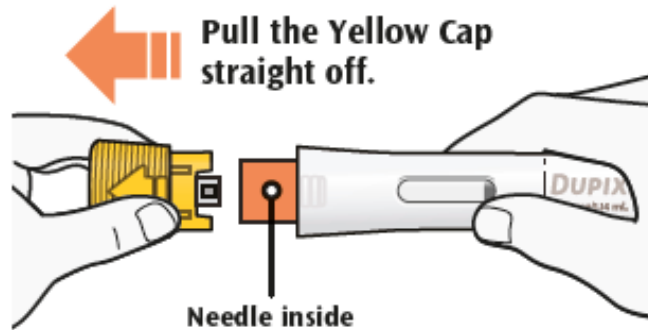
### C1. Remove Yellow Cap

**Do not** twist the Yellow Cap off.

**Do not** remove the Yellow Cap until you are ready to inject.

**Do not** press or touch the Orange Needle Cover with your fingers. The Needle is inside.

**⚠ Do not put the Yellow Cap back on the Pre-filled Pen after you have removed it.**



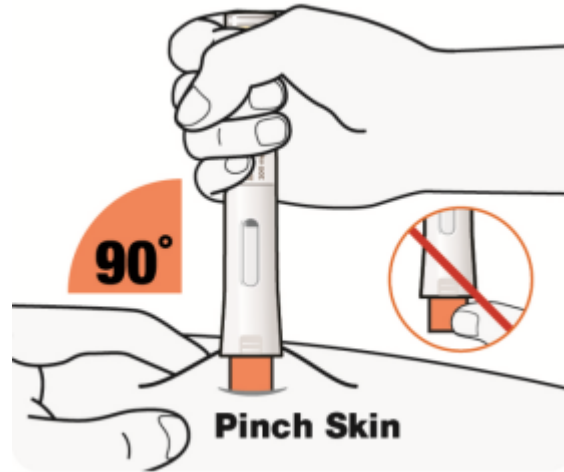
## C2. Pinch Skin and Place

For pediatric patients 2 years to less than 12 years old, pinch the skin before and during the injection.

Pinching of the skin is not needed for adult and adolescent patients aged 12 years and older.

- When placing the Orange Needle Cover on your skin, hold the Pre-filled Pen so that you can see the Window.
- Place the Orange Needle Cover on your skin at approximately a 90-degree angle.

**⚠ Do not press or touch the Orange Needle Cover with your fingers. The Needle is inside.**



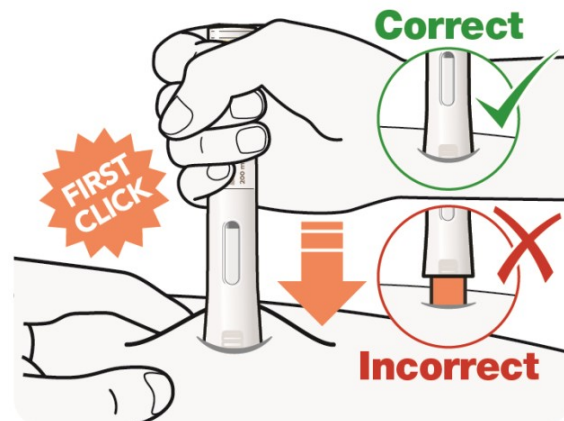
## C3. Press down

Press the Pre-filled Pen firmly against your skin until you cannot see the Orange Needle Cover, and hold.

- There will be a “click” when the injection starts.
- The window will start to turn Yellow.

The injection can take up to 15 seconds.

Pinching of skin is not needed for adults and children aged 12 years and older.



## C4. Hold firmly

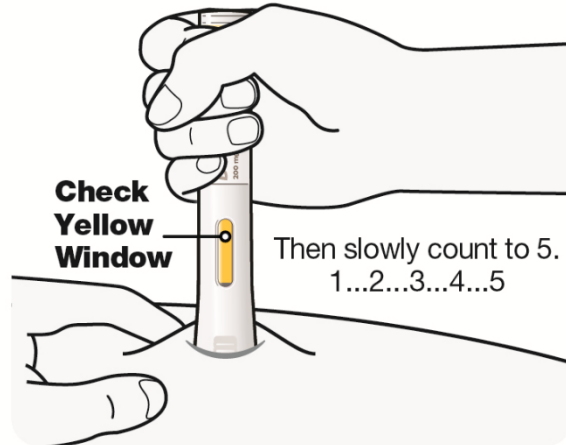
Keep holding the Pre-filled Pen firmly against your skin.

- You may hear a second click.
- Check that the entire Window has turned to Yellow.
- Then slowly count to 5.
- Then lift the pen up off the skin, your injection is complete.

If the Window does not turn completely Yellow, remove the pen and call your healthcare provider.


**⚠ Do not give yourself a second dose without speaking to your healthcare provider.**

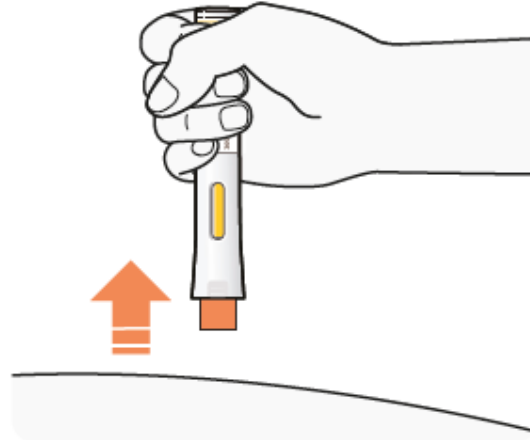
Pinching of skin is not needed for adults and children aged 12 years and older.



## C5. Remove

- After you have completed your injection pull straight up to remove Pre-filled Pen from the skin.
- If you see any blood at the site, lightly dab a cotton ball or gauze pad.

 **Do not rub your skin after the injection.**



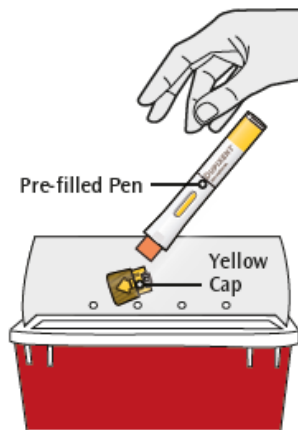
## D. Dispose

- Dispose of (throw away) your used DUPIXENT Pre-filled Pens, (Needle inside), and Yellow Caps in a puncture resistant (sharps disposal) container right away after use.

**Do not** dispose of (throw away) the used Pre-filled Pens (Needle inside), and Yellow Caps in your household trash.



**Do not put the Yellow Cap back on.**



## DUPIXENT (dupilumab injection) 300 mg Pre-filled Pen

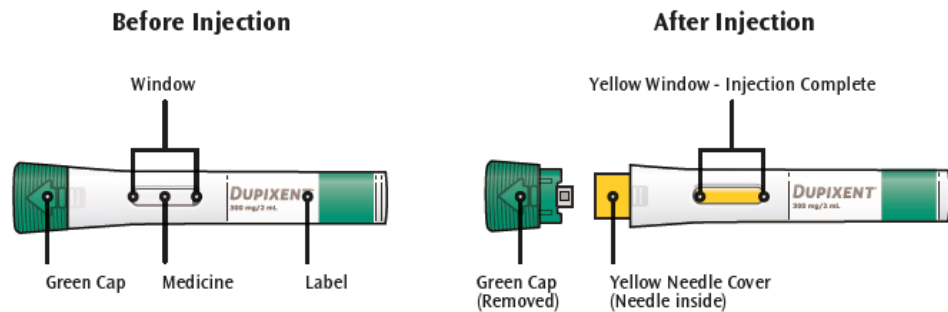
### Instructions for Use

Read the Instructions for Use before using the DUPIXENT Pre-filled Pen. Do not inject yourself or someone else until you have been shown how to inject DUPIXENT. Your healthcare provider can show you or your caregiver how to prepare and inject a dose of DUPIXENT before you try to do it yourself for the first time. The DUPIXENT Pre-filled Pen is only for use in adults, adolescents and pediatric patients aged 2 years and older. In children less than 12 years of age, Dupixent should be given by a caregiver. In adolescents 12 years of age and older, it is recommended that Dupixent be administered by or under supervision of an adult.

This device is a Single-use Pre-filled Pen. It contains 300 mg of DUPIXENT for injection under the skin (subcutaneous injection).

**Keep these instructions for future use. If you have any further questions, you should ask your healthcare professional or call 1 800 265-7927.**

The parts of the DUPIXENT Pre-filled Pen are shown in this picture.





## Important Information

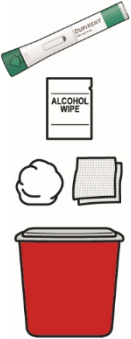


- Read all of the instructions carefully before using the Pre-filled Pen.
- Ask your healthcare provider how often you will need to inject the medicine.
- In children 12 years of age and older, it is recommended that Dupixent be administered by or under supervision of an adult.
- In children 2 years to less than 12 years of age, Dupixent should be given by a caregiver.
- Choose a different injection site for each injection.
- **Do not** use the Pre-filled Pen if it has been damaged.
- **Do not** use the Pre-filled Pen if the Green Cap is missing or not securely attached.
- **Do not** press or touch the Yellow Needle Cover with your fingers.
- **Do not** inject through clothes.
- **Do not** remove the Green Cap until just before you give the injection.
- **Do not** try to put the Green Cap back on the Pre-filled Pen.
- Throw away (dispose of) the Pre-filled Pen right away after use. See “Step D: Dispose” below.
- **Do not** re-use a Pre-filled Pen.

## How should I store DUPIXENT

- Keep the Pre-filled Pen(s) and all medicines out of the reach of children.
- Store unused Pre-filled Pens in the refrigerator between 2°C and 8°C (36°F and 46°F).
- Store Pre-filled Pens in the original carton to protect it from light.
- **Do not** keep Pre-filled Pens at room temperature (less than 25°C or less than 77°F) for more than 14 days. Throw away (dispose of) any Pre-filled Pens that have been left at room temperature for more than 14 days.
- **Do not** shake the Pre-filled Pen at any time.
- **Do not** heat the Pre-filled Pen.
- **Do not** freeze the Pre-filled Pen.
- **Do not** put the Pre-filled Pen into direct sunlight.

## A: Prepare

### A1. Gather supplies

<p>Ensure you have the following:</p> <ul style="list-style-type: none"> <li>• the DUPIXENT Pre-filled Pen</li> <li>• 1 alcohol wipe*</li> <li>• 1 cotton ball or gauze*</li> <li>• a sharps (puncture resistant) disposal container* (See Step D)</li> </ul> <p><i>* Items not included in the carton</i></p>	 <ul style="list-style-type: none"> <li>• the DUPIXENT Pen</li> <li>• 1 alcohol wipe*</li> <li>• 1 cotton ball or gauze*</li> <li>• a sharps disposal container* (See Step D)</li> </ul> <p><i>* Items not included in the carton.</i></p>
<p><b>A2. Look at the Label</b></p>	
<ul style="list-style-type: none"> <li>• Confirm that you have the correct product and dose.</li> </ul>	<p style="text-align: center;"><b>Look at the Label</b></p> 
<p><b>A3. Check Expiration Date</b></p>	
<ul style="list-style-type: none"> <li>• Check the expiration date.</li> </ul> <p><b>⚠ Do not use the Pre-filled Pen if the expiration date has passed.</b></p>	<p style="text-align: center;"><b>Expiration Date</b></p> 
<p><b>A4. Check the Medicine</b></p>	

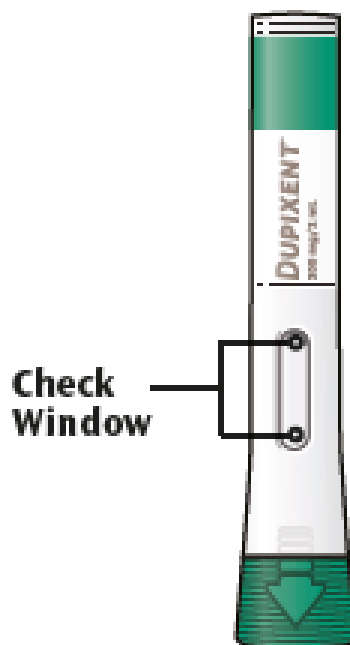
Look at the medicine through the Window on the Pre-filled Pen:

Check if the liquid is clear and colorless to pale yellow.

*Note: You may see an air bubble; this is normal.*




**⚠ Do not use the Pre-filled Pen if the liquid is discolored or cloudy, or if it contains visible flakes or particles.**

**⚠ Do not use the Pre-filled Pen if the Window is Yellow.**



## A5: Wait 45 minutes

Lay the Pre-filled Pen on a flat surface and let it naturally warm up at room temperature (less than 25°C or less than 77°F) for at least 45 minutes.

-  **Do not heat the Pre-filled Pen.**
-  **Do not put the Pre-filled Pen into direct sunlight.**
-  **Do not keep DUPIXENT at room temperature for more than 14 days. Dispose of (throw away) any DUPIXENT Pens that have been left at room temperature for longer than 14 days.**



## B. Choose your injection site

### B1. Recommended injection sites are:

- **Thigh**
- **Abdomen** except for the 5 cm (2 inches) around your belly button (navel).
- **Upper Arm** If a caregiver gives your dose, they can also use the outer area of the upper arm.

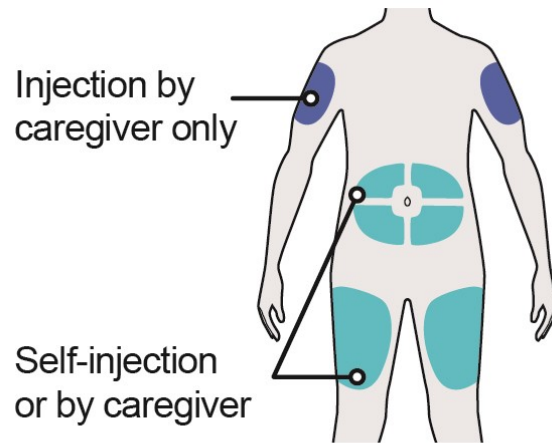
Choose a different injection site for each DUPIXENT injection.



**Do not inject through clothes.**

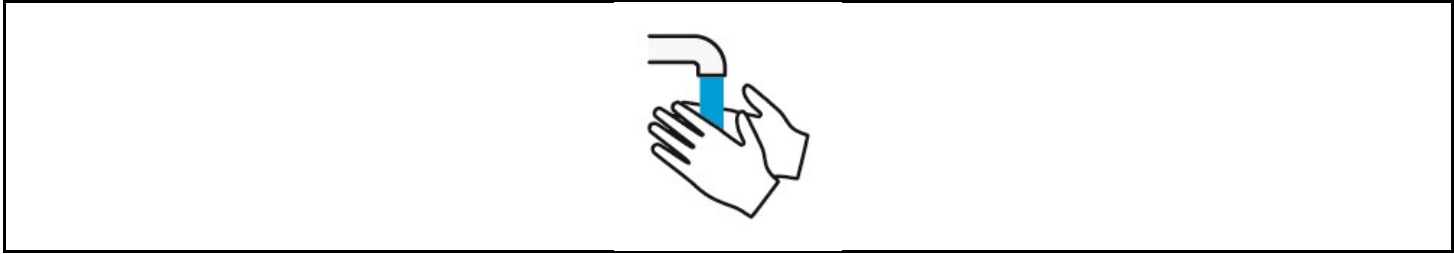


**Do not inject into skin that is tender, damaged, bruised or scarred.**




- Self-injection or by caregiver
- Injection by caregiver only

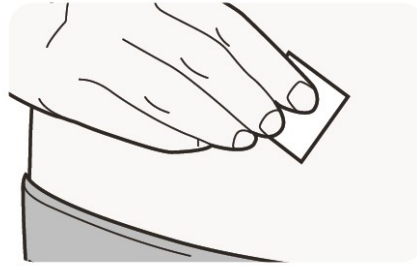
### B2. Wash Your Hands



### B3. Prepare the injection site

- Clean the injection site with an alcohol wipe.
- Let your skin dry before injecting.

 **Do not touch the injection site again or blow on it before the injection.**




## C. Give injection

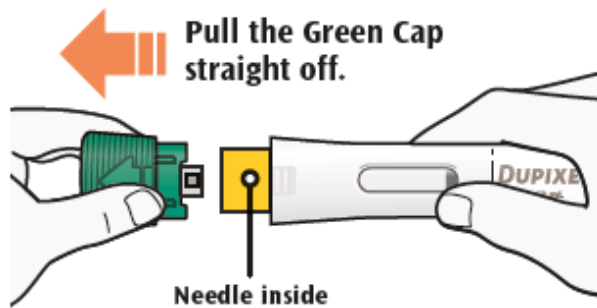
### C1. Remove Green Cap

**Do not** twist the Green Cap off.

**Do not** remove the Green Cap until you are ready to inject.

**Do not** press or touch the Yellow Needle Cover with your fingers. The Needle is inside.

 **Do not put the Green Cap back on the Pre-filled Pen after you have removed it.**



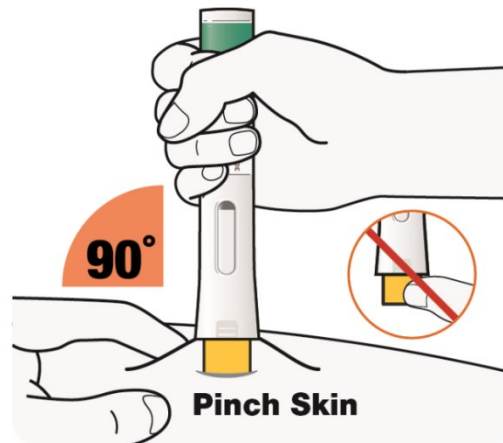
## C2. Pinch Skin and Place

For pediatric patients 2 years to less than 12 years old, pinch the skin before and during the injection.

Pinching of the skin is not needed for adults and adolescents aged 12 years and older.

- When placing the Yellow Needle Cover on your skin, hold the Pre-filled Pen so that you can see the Window.
- Place the Yellow Needle Cover on your skin at approximately a 90-degree angle.

**⚠ Do not press or touch the Yellow Needle Cover with your fingers. The Needle is inside.**



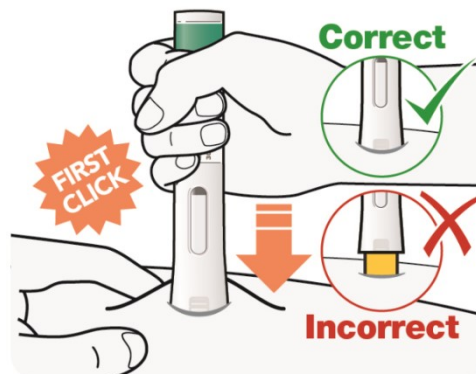
## C3. Press down

Press the Pre-filled Pen firmly against your skin until you cannot see the Yellow Needle Cover, and hold.

- There will be a “click” when the injection starts.
- The window will start to turn Yellow.

The injection can take up to 15 seconds.

Pinching of the skin is not needed for adults and children aged 12 years and older.






## C4. Hold firmly

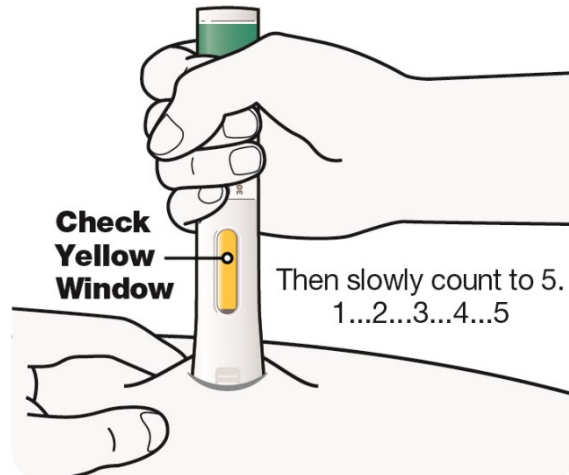
Keep holding the Pre-filled Pen firmly against your skin.

- You may hear a second click.
- Check that the entire Window has turned to Yellow.
- Then slowly count to 5.
- Then lift the pen up off the skin, your injection is complete.

If the Window does not turn completely Yellow, remove the pen and call your healthcare provider.


 **Do not give yourself a second dose without speaking to your healthcare provider.**

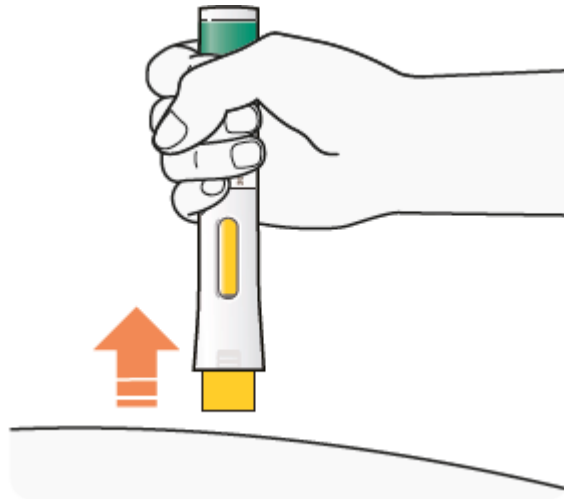
Pinching of the skin is not needed for adults and children aged 12 years and older.



## C5. Remove

- After you have completed your injection pull straight up to remove Pre-filled Pen from the skin.
- If you see any blood at the site, lightly dab a cotton ball or gauze pad.

 **Do not rub your skin after the injection.**



## D. Dispose

- Dispose of (throw away) your used DUPIXENT Pre-filled Pens, (Needle inside), and Green Caps in a puncture resistant (sharps disposal) container right away after use.

**Do not** dispose of (throw away) the used Pre-filled Pens (Needle inside), and Green Caps in your household trash.



**Do not put the Green Cap back on.**

