

PRODUCT MONOGRAPH
INCLUDING PATIENT MEDICATION INFORMATION

^{Pr}**ZIEXTENZO**[®]

Pegfilgrastim Injection

Sterile Solution, 6 mg (10 mg/mL)

Subcutaneous Use Only

Professed Standard

Hematopoietic Agent

Granulocyte Colony Stimulating Factor (G-CSF)

Sandoz Canada Inc.
110, rue de Lauzon
Boucherville, Québec
J4B 1E6
<https://www.sandoz.ca>

Date of Initial Authorization:
April 21, 2020

Date of Revision:
June 10, 2024

Submission Control Number: 283836

RECENT MAJOR LABEL CHANGES

| | |
|--|---------|
| 7 WARNINGS AND PRECAUTIONS, Carcinogenesis and Mutagenesis | 02/2021 |
| 7 WARNINGS AND PRECAUTIONS, Hematologic | 02/2021 |

TABLE OF CONTENTS

Sections or subsections that are not applicable at the time of authorization are not listed.

RECENT MAJOR LABEL CHANGES..... 2

PART I: HEALTH PROFESSIONAL INFORMATION 4

1 INDICATIONS 4

 1.1 Pediatrics..... 4

 1.2 Geriatrics 4

2 CONTRAINDICATIONS 4

3 SERIOUS WARNINGS AND PRECAUTIONS BOX 4

4 DOSAGE AND ADMINISTRATION..... 4

 4.1 Dosing Considerations 4

 4.2 Recommended Dose and Dosage Adjustment 5

 4.3 Reconstitution 5

 4.4 Administration 5

 4.5 Missed Dose 5

5 OVERDOSAGE 5

6 DOSAGE FORMS, STRENGTHS, COMPOSITION AND PACKAGING 5

7 WARNINGS AND PRECAUTIONS..... 6

 7.1 Special Populations 9

 7.1.1 Pregnant Women 9

 7.1.2 Breast-feeding 9

 7.1.3 Pediatrics 9

 7.1.4 Geriatrics 9

8 ADVERSE REACTIONS..... 9

 8.1 Adverse Reaction Overview 9

 8.2 Clinical Trial Adverse Reactions 9

 8.2.1 Clinical Trial Adverse Reactions: Pediatrics 12

 8.3 Less Common Clinical Trial Adverse Reactions 12

| | | |
|--|---|-----------|
| 8.4 | Abnormal Laboratory Findings: Hematologic, Clinical Chemistry and Other Quantitative Data | 12 |
| 8.5 | Post-Market Adverse Reactions..... | 13 |
| 9 | DRUG INTERACTIONS..... | 14 |
| 9.2 | Drug Interactions Overview | 14 |
| 9.3 | Drug-Behavioural Interactions | 14 |
| 9.4 | Drug-Drug Interactions | 14 |
| 9.5 | Drug-Food Interactions | 14 |
| 9.6 | Drug-Herb Interactions | 14 |
| 9.7 | Drug-Laboratory Test Interactions..... | 14 |
| 10 | CLINICAL PHARMACOLOGY | 14 |
| 10.1 | Mechanism of Action..... | 14 |
| 10.2 | Pharmacodynamics | 14 |
| 10.3 | Pharmacokinetics | 14 |
| 11 | STORAGE, STABILITY AND DISPOSAL..... | 15 |
| 12 | SPECIAL HANDLING INSTRUCTIONS..... | 15 |
| PART II: SCIENTIFIC INFORMATION | | 16 |
| 13 | PHARMACEUTICAL INFORMATION..... | 16 |
| 14 | CLINICAL TRIALS..... | 16 |
| 14.1 | Clinical Trials by Indication | 16 |
| 15 | MICROBIOLOGY | 18 |
| 16 | NON-CLINICAL TOXICOLOGY | 18 |
| 17 | SUPPORTING PRODUCT MONOGRAPHS..... | 20 |
| PATIENT MEDICATION INFORMATION | | 21 |

ZIEXTENZO® (PEGFILGRASTIM INJECTION) IS A BIOSIMILAR BIOLOGIC DRUG (BIOSIMILAR) TO NEULASTA®.

PART I: HEALTH PROFESSIONAL INFORMATION

1 INDICATIONS

Indications have been granted on the basis of similarity between ZIEXTENZO and the reference biologic drug Neulasta.

ZIEXTENZO (pegfilgrastim) is indicated to decrease the incidence of infection, as manifested by febrile neutropenia, in patients with non-myeloid malignancies receiving myelosuppressive anti-neoplastic drugs.

1.1 Pediatrics

Pediatrics (< 18 years of age): No data are available to Health Canada; therefore, Health Canada has not authorized an indication for pediatric use.

1.2 Geriatrics

No overall differences in safety or effectiveness were observed between these patients and younger patients, and other reported clinical experience has not identified differences in responses between the elderly and younger patients; however, due to the small number of elderly subjects, small but clinically relevant differences cannot be excluded.

2 CONTRAINDICATIONS

ZIEXTENZO (pegfilgrastim) is contraindicated in patients with known hypersensitivity to *E. coli*-derived products, pegfilgrastim, filgrastim, or any other component of the product, including any non-medicinal ingredient, or component of the container. For a complete listing, see **6 DOSAGE FORMS, STRENGTHS, COMPOSITION AND PACKAGING**.

3 SERIOUS WARNINGS AND PRECAUTIONS BOX

Serious Warnings and Precautions

- Splenic rupture, including fatal cases, has been reported following the administration of pegfilgrastim and its parent compound, filgrastim (see **7 WARNINGS AND PRECAUTIONS: General**).
- Severe sickle cell crises have been associated with the use of pegfilgrastim in patients with sickle cell trait or sickle cell disease. Severe sickle cell crises, in some cases resulting in death, have also been associated with filgrastim, the parent compound of pegfilgrastim (see **7 WARNINGS AND PRECAUTIONS: Hematologic**).

4 DOSAGE AND ADMINISTRATION

4.1 Dosing Considerations

- ZIEXTENZO should be administered no sooner than 24 hours after the administration of cytotoxic

chemotherapy (see 7 WARNINGS AND PRECAUTIONS).

- Renal impairment, including end-stage renal disease, appears to have no effect on the pharmacokinetics of pegfilgrastim and no dosage adjustment is required.

4.2 Recommended Dose and Dosage Adjustment

The recommended dosage of ZIEXTENZO is a single subcutaneous injection of 6 mg, administered once per cycle of chemotherapy (see 7 WARNINGS AND PRECAUTIONS).

Pediatrics (<18 years of age): No data are available to Health Canada; therefore, Health Canada has not authorized an indication for pediatric use (see 1.1 PEDIATRICS).

No dosage adjustment required in renal impairment.

4.3 Reconstitution

Not applicable. Product does not need to be reconstituted.

4.4 Administration

ZIEXTENZO is intended for subcutaneous injection only and should not be given by any other route of administration. ZIEXTENZO should not be mixed with any diluents. ZIEXTENZO should not be vigorously shaken.

After the medicine has been injected, the needle guard will be activated to cover the needle. The needle guard is intended to protect healthcare professionals, care providers and patients from accidental needle sticks after the injection.

4.5 Missed Dose

If a scheduled dose is missed, ZIEXTENZO should not be administered less than 14 days before subsequent administration of cytotoxic chemotherapy.

5 OVERDOSAGE

The maximum tolerated dose of ZIEXTENZO (pegfilgrastim) has not been determined in humans. Pegfilgrastim administered at a dose of 300 mcg/kg (n = 12), approximately three times the recommended dose, exhibited an adverse event profile similar to that observed at the recommended dose.

For management of a suspected drug overdose, contact your regional poison control centre.

6 DOSAGE FORMS, STRENGTHS, COMPOSITION AND PACKAGING

To help ensure the traceability of biologic products, including biosimilars, health professionals should recognise the importance of recording both the brand name and the non-proprietary (active ingredient) name as well as other product-specific identifiers such as the Drug Identification Number (DIN) and the batch/lot number of the product supplied.

Table – Dosage Forms, Strengths, Composition and Packaging

| Route of Administration | Dosage Form / Strength/Composition | Non-medicinal Ingredients |
|--------------------------------|--|---|
| Subcutaneous (SC) | Sterile solution for injection/6 mg (10 mg/mL) | Acetic acid, polysorbate 20, sorbitol, sodium hydroxide and water for injection, USP. |

ZIEXTENZO is supplied as a preservative-free solution (0.6 mL) containing 6 mg of pegfilgrastim (10 mg/mL) in a single-use pre-filled syringe with a 29 gauge, ½ inch needle, with a *BD UltraSafe Passive™ Needle Guard to prevent accidental needle stick injury.

*BD UltraSafe Passive™ is a trademark of Becton, Dickinson and Company.

ZIEXTENZO is supplied in a carton containing one blister packaged pre-filled syringe.

Description

ZIEXTENZO (pegfilgrastim) is a biosimilar biologic drug that is a long-acting form of recombinant human granulocyte colony-stimulating factor (r-metHuG-CSF) or filgrastim. ZIEXTENZO is composed of filgrastim with a 20,000 dalton polyethylene glycol (PEG) molecule covalently bound to the N-terminal methionine residue. Filgrastim is a 175 amino acid protein with a molecular weight of 18,800 daltons; ZIEXTENZO has a total molecular weight of 39,000 daltons.

7 WARNINGS AND PRECAUTIONS

Please see **3 SERIOUS WARNINGS AND PRECAUTIONS BOX**.

General

ZIEXTENZO (pegfilgrastim) has not been evaluated for PBPC (peripheral blood progenitor cell) mobilization. Therefore, it should not be used in that setting.

Splenic Rupture: Splenic rupture, including fatal cases, has been reported following the administration of pegfilgrastim and its parent compound, filgrastim. Patients receiving ZIEXTENZO who report left upper abdominal and/or shoulder tip pain should be evaluated for an enlarged spleen or splenic rupture.

Simultaneous Use with Chemotherapy and Radiation Therapy: The safety and efficacy of ZIEXTENZO administered concurrently with cytotoxic chemotherapy have not been established. Because of the potential for an increase in sensitivity of rapidly dividing myeloid cells to cytotoxic chemotherapy, ZIEXTENZO should not be administered in the period between 14 days before and 24 hours after administration of cytotoxic chemotherapy (see **4 DOSAGE AND ADMINISTRATION**).

The safety and efficacy of ZIEXTENZO have not been evaluated in patients receiving chemotherapy associated with delayed myelosuppression (eg, nitrosoureas), mitomycin C, or myelosuppressive doses of anti-metabolites such as 5-fluorouracil (5-FU). Concomitant use of ZIEXTENZO with 5-FU or other anti-metabolites has not been evaluated in humans, although it has been studied and shown to potentiate myelosuppression in animal models (see **16 NON-CLINICAL TOXICOLOGY**).

The safety and efficacy of ZIEXTENZO have not been evaluated in patients receiving radiation therapy

except for patients with breast or lung cancer.

Carcinogenesis and Mutagenesis

No carcinogenesis or mutagenesis studies were conducted with ZIEXTENZO.

Potential Effect on Malignant Cells: ZIEXTENZO (pegfilgrastim) and filgrastim are growth factors that primarily stimulate production of neutrophils and neutrophil precursors by binding to the G-CSF receptor. Overall, the possibility that ZIEXTENZO can act as a growth factor for any tumour type cannot be excluded. The use of pegfilgrastim in chronic myeloid leukemia (CML) and myelodysplastic syndrome (MDS) has not been studied.

MDS and AML in Breast and Lung Cancer Patients: In the post-marketing observational study setting, findings showed that pegfilgrastim is associated with an increased risk of MDS and AML in breast and lung cancer patients when used in conjunction with chemotherapy and/or radiotherapy. Monitor patients for signs and symptoms of MDS/AML in these settings.

Cardiovascular

Capillary Leak Syndrome: Capillary leak syndrome (CLS) has been reported after the administration of pegfilgrastim or filgrastim. CLS can cause circulatory shock and may be fatal, and is characterized by hypotension, hypoalbuminemia, edema, and hemoconcentration. Episodes vary in frequency, severity and may be life-threatening if treatment is delayed. Patients who develop symptoms of capillary leak syndrome should be closely monitored and receive treatment, which may include a need for intensive care.

Aortitis: Aortitis has been reported in patients receiving pegfilgrastim and may present with generalized signs and symptoms such as fever and increased inflammatory markers. Consider aortitis in patients who develop these signs and symptoms without known etiology.

Hematologic

Sickle Cell Crises: Severe sickle cell crises have been associated with the use of pegfilgrastim in patients with sickle cell trait or sickle cell disease. Severe sickle cell crises, in some cases resulting in death, have also been associated with filgrastim, the parent compound of pegfilgrastim. Only physicians qualified by specialized training or experience in the treatment of patients with sickle cell trait and sickle cell disease should prescribe ZIEXTENZO for such patients, and only after careful consideration of the potential risks and benefits.

Leukocytosis: In clinical studies with pegfilgrastim, white blood cell counts of $100 \times 10^9/L$ or greater have been reported in less than 1% of patients with cancer receiving myelosuppressive chemotherapy ($n = 930$), and were not associated with any reported adverse clinical effects (see **7 WARNINGS AND PRECAUTIONS, Monitoring and Laboratory Tests**).

In studies of pegfilgrastim administration after chemotherapy, most reported side effects were consistent with those usually seen as a result of cytotoxic chemotherapy (see **8 ADVERSE REACTIONS**). Because of the potential for patients to receive full doses of chemotherapy on the prescribed schedule, patients may be at greater risk of thrombocytopenia, anemia, and non-hematologic consequences of increased chemotherapy doses (please refer to the prescribing information for specific chemotherapy agents). Regular monitoring of hematocrit value and platelet count is recommended. Furthermore, care should be exercised in the administration of ZIEXTENZO in conjunction with drugs known to lower platelet count.

Thrombocytopenia: Thrombocytopenia, including serious events, has been reported in patients

receiving pegfilgrastim. Platelet counts should be monitored regularly as clinically indicated.

Immune

Hypersensitivity/Allergic Reactions: Hypersensitivity including serious allergic reactions and anaphylactic reactions, skin rash, urticaria and erythema/flushing occurring on initial or subsequent treatment have been reported both with pegfilgrastim and filgrastim. In some cases, symptoms have recurred with rechallenge, suggesting a causal relationship. In rare cases, allergic reactions, including anaphylactic reactions, recurred within days after initial anti-allergic treatment was discontinued. If a serious allergic reaction or an anaphylactic reaction occurs, appropriate therapy should be administered and further use of ZIEXTENZO should be discontinued. Antibodies to filgrastim or pegfilgrastim have been reported, although no neutralizing antibodies have been reported (see **8 ADVERSE REACTIONS, Immunogenicity**). Do not administer filgrastim to patients with a history of hypersensitivity to filgrastim or pegfilgrastim.

Cutaneous Vasculitis: Uncommon ($\geq 1/1,000$ to $< 1/100$) events of cutaneous vasculitis have been reported in patients treated with pegfilgrastim. The mechanism of vasculitis in patients receiving ZIEXTENZO is unknown.

Monitoring and Laboratory Tests

To assess a patient's hematologic status and ability to tolerate myelosuppressive chemotherapy, a complete blood count (CBC) and platelet count should be obtained before chemotherapy is administered. Pegfilgrastim produced ANC (absolute neutrophil count) profiles similar to daily filgrastim, including earlier ANC nadir, shorter duration of severe neutropenia, and accelerated ANC recovery, compared with ANC profiles observed without growth factor support. Regular monitoring of hematocrit value, white blood cell count and platelet count, as clinically indicated, is recommended.

Renal

Glomerulonephritis: Glomerulonephritis has been reported in patients receiving filgrastim and pegfilgrastim. Generally, events of glomerulonephritis resolved after dose reduction or withdrawal of filgrastim and pegfilgrastim. Urinalysis monitoring is recommended.

Reproductive Health: Female and Male Potential

No studies evaluating sexual function or reproduction in humans were conducted with ZIEXTENZO.

Respiratory

Acute respiratory distress syndrome (ARDS) has been reported following administration of pegfilgrastim, and is postulated to be secondary to an influx of neutrophils to sites of inflammation in the lungs. Neutropenic patients receiving ZIEXTENZO who develop fever, lung infiltrates, or respiratory distress should be evaluated for the possibility of ARDS. In the event that ARDS occurs, ZIEXTENZO should be discontinued and/or withheld until resolution of ARDS and patients should receive appropriate medical management for this condition.

7.1 Special Populations

7.1.1 Pregnant Women

There were no pregnant women exposed to pegfilgrastim in clinical trials. ZIEXTENZO should be used during pregnancy only if the potential benefit outweighs the risk to the fetus (see **16 NON-CLINICAL TOXICOLOGY**).

7.1.2 Breast-feeding

It is unknown if ZIEXTENZO (pegfilgrastim) is excreted in human milk. Precaution should be exercised because many drugs can be excreted in human milk. Where an assessment of the risk to benefit ratio suggests the use of this product in nursing mothers, feeding formula should be substituted for breast feeding.

7.1.3 Pediatrics

Pediatrics (< 18 years of age): No data are available to Health Canada; therefore, Health Canada has not authorized an indication for pediatric use.

7.1.4 Geriatrics

Geriatrics (> 65 years of age): Of the total number of subjects with cancer who received pegfilgrastim in clinical studies (n = 930), 139 subjects (15%) were 65 years or older and 18 subjects (2%) were 75 years or older. No overall differences in safety or effectiveness were observed between these patients and younger patients, and other reported clinical experience has not identified differences in responses between the elderly and younger patients; however, due to the small number of elderly subjects, small but clinically relevant differences cannot be excluded.

8 ADVERSE REACTIONS

The adverse drug reaction profiles reported in clinical studies that compared ZIEXTENZO to the reference biologic drug were comparable. The description of adverse reactions in this section is based on clinical experience with the reference biologic drug.

8.1 Adverse Reaction Overview

The most frequently reported study drug-related adverse event was bone pain, for which the incidence in patients treated with pegfilgrastim was similar to that in patients treated with filgrastim. Bone pain was generally reported as mild-to-moderate and could be controlled in most patients with non-narcotic analgesia.

See **7 WARNINGS AND PRECAUTIONS** regarding **Splenic Rupture, ARDS, Hypersensitivity/Allergic Reactions, and Sickle Cell Crises**.

8.2 Clinical Trial Adverse Reactions

Clinical trials are conducted under very specific conditions. The adverse reaction rates observed in the clinical trials; therefore, may not reflect the rates observed in practice and should not be compared to the rates in the clinical trials of another drug. Adverse reaction information from clinical trials may be

useful in identifying and approximating rates of adverse drug reactions in real-world use.

Safety data are based on 7 randomized clinical trials involving 932 patients with lymphoma and solid tumours (breast and thoracic) who received pegfilgrastim after non-myeloablative cytotoxic chemotherapy. Common adverse events occurred at similar rates between the treatment arms in both the filgrastim-controlled trials (pegfilgrastim, n = 465; filgrastim, n = 331) and the placebo-controlled trial (pegfilgrastim, n = 467; placebo, n = 461). Most adverse experiences were attributed by the investigator as the sequelae of the underlying malignancy or cytotoxic chemotherapy. In the filgrastim-controlled trials, these adverse experiences occurred at rates between 15% and 72% and included: nausea, fatigue, alopecia, diarrhea, vomiting, constipation, fever, anorexia, skeletal pain, headache, taste perversion, dyspepsia, myalgia, insomnia, abdominal pain, arthralgia, generalized weakness, peripheral edema, dizziness, granulocytopenia, stomatitis, mucositis and neutropenic fever. A summary of the most frequently reported adverse reactions in these randomized clinical trials can be found in Table 2 and 3.

In clinical trials comparing pegfilgrastim to filgrastim, medullary bone pain was reported in 26% of pegfilgrastim-treated patients, which was comparable to the incidence in filgrastim-treated patients. In the study comparing pegfilgrastim to placebo, the incidence of bone pain was 23% vs. 16%, respectively. This bone pain was generally reported to be of mild-to-moderate severity. Approximately 17% (for all bone pain type AEs; 10% for specifically “bone pain”) of all subjects utilized non-narcotic analgesics and less than 6% utilized narcotic analgesics in association with bone pain. No patient withdrew from study due to bone pain.

Across all studies, no life-threatening or fatal adverse events were attributed to pegfilgrastim. There was only one serious adverse event (dyspnea) reported as possibly related to pegfilgrastim in a single patient. No events of pleuritis, pericarditis, or other major systemic reactions to pegfilgrastim were reported.

No clinically significant changes in vital signs were observed. No evidence of interaction of pegfilgrastim with other drugs was observed in the course of clinical trials (see **7 WARNINGS AND PRECAUTIONS**).

Table 1 – Most Frequently* Reported Adverse Reactions in Randomized Clinical Trials with Filgrastim as Comparator

| Body System and Preferred Term | Pegfilgrastim n = 465 (%) | Filgrastim n = 331 (%) |
|---------------------------------------|--|---------------------------------------|
| Application Site | | |
| Injection Site Pain | 16 (3%) | 9 (3%) |
| Body as a whole | | |
| Pain | 8 (2%) | 4 (1%) |
| Chest Pain (Non-Cardiac) | 4 (1%) | 3 (1%) |
| Edema Periorbital | 3 (1%) | 0 (0%) |
| Fever | 3 (1%) | 4 (1%) |
| CNS/PNS | | |

| Body System and Preferred Term | Pegfilgrastim n = 465 (%) | Filgrastim n = 331 (%) |
|--------------------------------|---------------------------------|------------------------------|
| Headache | 20 (4%) | 12 (4%) |
| Musculoskeletal | | |
| Skeletal Pain | 96 (21%) | 89 (27%) |
| Myalgia | 32 (7%) | 25 (8%) |
| Arthralgia | 27 (6%) | 19 (6%) |
| Back Pain | 19 (4%) | 26 (8%) |
| Limb Pain | 12 (3%) | 7 (2%) |
| Musculoskeletal Pain | 5 (1%) | 4 (1%) |
| Neck Pain | 4 (1%) | 3 (1%) |

* Most frequently reported events were considered to be those events reported in $\geq 1\%$ of the patients in the pegfilgrastim group.

Table 2 – Most Frequently* Reported Adverse Reactions in Randomized Clinical Trials with Placebo Control

| Body System and Preferred Term | Pegfilgrastim n = 467 (%) | Placebo n = 461 (%) |
|---|---------------------------------|---------------------------|
| Blood and Lymphatic System Disorders | | |
| Leukocytosis | 5 (1%) | 1 (0%) |
| Gastrointestinal Disorders | | |
| Diarrhea | 9 (2%) | 10 (2%) |
| General Disorders and Administration Site Conditions | | |
| Pyrexia | 8 (2%) | 9 (2%) |
| Fatigue | 3 (1%) | 5 (1%) |
| Infections and Infestations | | |
| Influenza | 6 (1%) | 5 (1%) |
| Musculoskeletal and Connective Tissue Disorders | | |
| Bone Pain | 62 (13%) | 41 (9%) |
| Myalgia | 26 (6%) | 23 (5%) |
| Arthralgia | 32 (7%) | 19 (4%) |

| Body System and Preferred Term | Pegfilgrastim n = 467 (%) | Placebo n = 461 (%) |
|---|--|------------------------------------|
| Polymyalgia | 8 (2%) | 7 (2%) |
| Musculoskeletal Pain | 14 (3%) | 5 (1%) |
| Pain in Limb | 11 (2%) | 5 (1%) |
| Back Pain | 8 (2%) | 4 (1%) |
| Polyarthralgia | 5 (1%) | 0 (0%) |
| Nervous System Disorders | | |
| Headache | 6 (1%) | 2 (0%) |
| Skin and Subcutaneous Tissue Disorders | | |
| Alopecia | 8 (2%) | 9 (2%) |

* Most frequently reported events were considered to be those events reported in $\geq 1\%$ of the patients in the pegfilgrastim group.

8.2.1 Clinical Trial Adverse Reactions: Pediatrics

No data are available to Health Canada; therefore, Health Canada has not authorized an indication for pediatric use.

8.3 Less Common Clinical Trial Adverse Reactions

The following adverse drug reactions were reported at an incidence of $< 1\%$ in controlled clinical studies (occurring in more than 1 patient, with higher frequency than filgrastim):

General Disorders and Administration Site Conditions: injection site bruising;

Infections and Infestations: rhinitis;

Nervous System Disorders: hypertonia;

Skin and Subcutaneous Tissue Disorders: periorbital edema.

The following adverse drug reactions were reported at an incidence of $< 1\%$ in controlled clinical studies (occurring in more than 1 patient, with higher frequency than placebo):

General Disorders and Administration Site Conditions: chest pain, pain.

8.4 Abnormal Laboratory Findings: Hematologic, Clinical Chemistry and Other Quantitative Data

Spontaneously reversible elevations in lactate dehydrogenase (LDH), alkaline phosphatase, and uric acid of mild-to-moderate severity were observed. Most changes have been attributed to post-cytokine bone marrow expansion as well as to chemotherapy and metastatic disease. The incidences of these changes, presented for pegfilgrastim versus filgrastim and placebo, were: LDH (18% versus 29% and 18%), alkaline phosphatase (11% versus 16% and 12%), and uric acid [10% versus 9% and 13% (1% of uric acid reported cases for filgrastim and pegfilgrastim treatment groups were classified as severe)].

In clinical studies with pegfilgrastim, white blood cell counts of $100 \times 10^9/L$ or greater have been reported in less than 1% of patients with cancer receiving myelosuppressive chemotherapy (n = 930), and were not associated with any reported adverse clinical effects.

Immunogenicity

As with all therapeutic proteins, there is a potential for immunogenicity. The incidence of antibody development in patients receiving pegfilgrastim has not been adequately determined. While available data suggest that a small proportion of patients developed binding antibodies to filgrastim or pegfilgrastim, the nature and specificity of these antibodies has not been adequately studied. No neutralizing antibodies have been detected using a cell-based bioassay in 46 (9%, n = 534) patients who apparently developed binding antibodies. The detection of antibody formation is highly dependent on the sensitivity and specificity of the assay, and the observed incidence of antibody positivity in an assay may be influenced by several factors including sample handling, concomitant medications, and underlying disease. Therefore, comparison of the incidence of antibodies to pegfilgrastim with the incidence of antibodies to other products may be misleading.

Cytopenias resulting from an antibody response to exogenous growth factors have been reported on rare occasions in patients treated with other recombinant growth factors. There is a theoretical possibility that an antibody directed against pegfilgrastim may cross-react with endogenous G-CSF, resulting in immune-mediated neutropenia, but this has not been observed in clinical studies.

For detailed immunogenicity information for ZIEXTENZO, see **14 CLINICAL TRIALS, Immunogenicity**.

8.5 Post-Market Adverse Reactions

In addition to the events listed above, reports of adverse reactions have been identified post-market in patients receiving pegfilgrastim, including:

- Splenomegaly (enlarged spleen) and Splenic rupture (see **7 WARNINGS AND PRECAUTIONS General, Splenic Rupture**)
- Acute respiratory distress syndrome (ARDS) (see **7 WARNINGS AND PRECAUTIONS Respiratory**)
- Allergic reactions (see **7 WARNINGS AND PRECAUTIONS Immune Hypersensitivity/Allergic Reactions**)
- Sickle cell crisis (see **7 WARNINGS AND PRECAUTIONS Hematologic**)
- Myelodysplastic Syndrome (MDS) and Acute Myeloid Leukaemia (AML) in Breast and Lung Cancer Patients (see **7 WARNINGS AND PRECAUTIONS Carcinogenesis and Mutagenesis**)
- Injection site reactions (pain, induration, and local erythema)
- Generalized erythema and flushing
- Sweet's syndrome (acute febrile neutrophilic dermatosis)
- Cutaneous Vasculitis (see **7 WARNINGS AND PRECAUTIONS Immune**)
- Capillary Leak Syndrome (see **7 WARNINGS AND PRECAUTIONS Cardiovascular**)
- Glomerulonephritis (see **7 WARNINGS AND PRECAUTIONS Renal**)
- Aortitis (see **7 WARNINGS AND PRECAUTIONS Cardiovascular**)

9 DRUG INTERACTIONS

9.2 Drug Interactions Overview

Drug interactions between pegfilgrastim and other drugs have not been studied. Drugs such as lithium that may potentiate the release of neutrophils should be used with caution; such patients should have more frequent monitoring of their neutrophil counts.

9.3 Drug-Behavioural Interactions

Drug-behavioural interactions have not been established.

9.4 Drug-Drug Interactions

Interactions with other drugs have not been established.

9.5 Drug-Food Interactions

Interactions with food have not been established.

9.6 Drug-Herb Interactions

Interactions with herbal products have not been established.

9.7 Drug-Laboratory Test Interactions

Increased hematopoietic activity of the bone marrow in response to growth factor therapy has been associated with transient positive bone-imaging changes. This should be considered when interpreting bone-imaging results.

10 CLINICAL PHARMACOLOGY

10.1 Mechanism of Action

Both pegfilgrastim and filgrastim are colony-stimulating factors that act on hematopoietic cells by binding to specific cell surface receptors thereby stimulating proliferation, differentiation, commitment, and end cell functional activation. Studies on cellular proliferation, receptor binding, and neutrophil function demonstrate that filgrastim and pegfilgrastim have the same mechanism of action. Pegfilgrastim has reduced renal clearance and prolonged persistence in vivo as compared to filgrastim.

10.2 Pharmacodynamics

See information in 10.3 below.

10.3 Pharmacokinetics

The pharmacokinetics and pharmacodynamics of pegfilgrastim were studied in patients with cancer. The pharmacokinetics of pegfilgrastim were nonlinear in cancer patients and clearance decreased with increases in dose. Neutrophil-mediated clearance is an important component of the clearance of pegfilgrastim, and serum clearance is related to the number of neutrophils (neutrophil-mediated, self-regulating clearance). Consistent with a self-regulating clearance mechanism, the serum concentration of pegfilgrastim declined rapidly at the onset of neutrophil recovery that followed myelosuppressive chemotherapy. In addition to numbers of neutrophils, body weight appeared to be a factor. Patients

with higher body weights experienced higher systemic exposure to pegfilgrastim after receiving a dose normalized for body weight. A large variability in the pharmacokinetics of pegfilgrastim was observed in cancer patients. The half-life of pegfilgrastim ranged from 25 to 49 hours after SC injection.

Table 3 – Summary of pegfilgrastim Pharmacokinetic Parameters in Cancer Patients after SC administration

| | C_{max} | t_½ (h) | AUC_{0-∞} | CL |
|-------------------------|------------------------|--------------------------|--------------------------|-----------------------|
| Single dose mean | 78.3-175 ng/mL | 25-49 hr | 5640-15000 ng·hr/mL | 6.68-17.7 mL/hr/kg |

* Doses of 100 mcg/kg and 6 mg

Special Populations and Conditions

No gender-related differences were observed in the pharmacokinetics of pegfilgrastim, and no differences were observed in the pharmacokinetics of geriatric patients with cancer (≥ 65 years of age) compared to younger patients (< 65 years of age) (see **7 WARNINGS AND PRECAUTIONS, Special Populations, Geriatrics**). Renal impairment, including end-stage renal disease, appears to have no effects on the pharmacokinetics of pegfilgrastim. The pharmacokinetic profile in pediatric populations or in patients with hepatic insufficiency has not been assessed. The effect of race on pharmacokinetics has not been adequately assessed.

Pediatrics (<18 years of age): No data are available to Health Canada; therefore, Health Canada has not authorized an indication for pediatric use.

11 STORAGE, STABILITY AND DISPOSAL

ZIEXTENZO (pegfilgrastim) should be stored refrigerated at 2°C to 8°C in the original pack to protect from light. Do not shake. Do not freeze. ZIEXTENZO may be allowed to reach room temperature (not above 35°C) for a maximum single period of up to 120 hours. ZIEXTENZO left at room temperature for more than 120 hours should be discarded.

Avoid freezing; if accidentally frozen, thaw in the refrigerator before administration. Discard ZIEXTENZO if frozen more than once.

ZIEXTENZO should be inspected visually for particulate matter and discolouration prior to administration.

ZIEXTENZO should not be administered if discolouration or particulates are observed.

12 SPECIAL HANDLING INSTRUCTIONS

ZIEXTENZO should not be vigorously shaken. Freezing should be avoided. Store in the carton provided to protect from light.

PART II: SCIENTIFIC INFORMATION

13 PHARMACEUTICAL INFORMATION

Drug Substance

| | |
|---------------------------------------|--|
| Proper name: | pegfilgrastim |
| Chemical name: | Pegylated recombinant methionyl human granulocyte colony-stimulating factor |
| Molecular formula and molecular mass: | $\text{CH}_3\text{O}(\text{C}_2\text{H}_4\text{O})_n\text{C}_3\text{H}_6\text{C}_{845}\text{H}_{1338}\text{N}_{223}\text{O}_{243}\text{S}_9$ Pegfilgrastim has a total molecular weight of approximately 40,000 daltons. |
| Structural formula: | Pegfilgrastim is composed of filgrastim (recombinant methionyl human G-CSF) with an approximately 20,000 dalton polyethylene glycol (PEG) molecule covalently bound to the N-terminal methionine residue. Filgrastim is a 175 amino acid protein manufactured by recombinant DNA technology. Filgrastim is produced by <i>Escherichia coli</i> (<i>E. coli</i>) bacteria into which the human G-CSF gene has been inserted. Filgrastim has an amino acid sequence that is identical to the natural sequence predicted by human DNA sequence analysis, except for the addition of an N-terminal methionine necessary for expression in <i>E. coli</i> . Because filgrastim is produced in <i>E. coli</i> , the protein is nonglycosylated and thus differs from G-CSF isolated from a human cell. |

Product Characteristics:

ZIEXTENZO (pegfilgrastim) is a sterile, clear and colourless to slightly yellowish liquid.

14 CLINICAL TRIALS

14.1 Clinical Trials by Indication

Table 4 – Study Demographics and Trial Design

| Study # | Trial design | Dosage, route of administration and duration | Study subjects (n = number) | Mean age (Range) years | Gender |
|---------|--|--|--|---|--------------------|
| 980226 | Phase 3, double-blind, randomized, filgrastim controlled | Single SC dose of 100 mcg/kg/day pegfilgrastim or daily SC dose of 5 mcg/kg/day filgrastim, up to 4 cycles | 310 (154 peg-filgrastim, 156 filgrastim) | 50.9 (25-81) pegfilgrastim 51.8 (26-87) filgrastim | 306 female, 4 male |

| Study # | Trial design | Dosage, route of administration and duration | Study subjects (n = number) | Mean age (Range) years | Gender |
|----------|--|---|--|---|--------------------|
| 990749 | Phase 3, double-blind, randomized, filgrastim controlled | 6 mg single dose of pegfilgrastim SC or 5 mcg/kg/day filgrastim up to 14 days, up to 4 cycles | 157 (80 peg-filgrastim, 77 filgrastim) | 51.9 (31-75) pegfilgrastim 52.6 (30-74) filgrastim | 156 female, 1 male |
| 20010144 | Phase 3, double-blind, placebo-controlled, randomized | Pegfilgrastim, 6 mg SC, single dose every 3 weeks, up to 12 weeks | 928 (463 peg-filgrastim, 465 placebo) | 51.9 (21-88) pegfilgrastim 52.1 (24-76) placebo | 99% female |

Study results

Clinical Experience: Response to pegfilgrastim

Pegfilgrastim administered as a single SC injection, after each cycle of chemotherapy, has been shown to be safe and effective in reducing neutropenia and associated clinical sequelae in a variety of chemotherapy settings.

Pegfilgrastim has been evaluated in three Phase 3, randomized, double-blind, controlled studies. Results from two active controlled studies (n = 467) conducted in patients with breast cancer undergoing up to 4 cycles of chemotherapy with doxorubicin and docetaxel demonstrated non-inferiority of pegfilgrastim to filgrastim. A clinically and statistically similar reduction in the duration of severe neutropenia (absolute neutrophil count [ANC] < 0.5 x 10⁹/L; WHO grade 4) was seen in patients who received a single injection of pegfilgrastim, either 6 mg fixed dose 5 or 100 mcg/kg, compared with patients who received a mean of 11 daily injections (cycle 1) of filgrastim 5 mcg/kg/day.

The mean (std dev) duration of severe neutropenia in cycle 1 in patients who received a single fixed-dose (6 mg) SC injection of pegfilgrastim (n = 68) was 1.8 (1.4) days compared with 1.6 (1.1) days in patients who received daily injections (range: 7-14 injections) of filgrastim (n = 62). The difference in means was 0.18 days (95% CI of -0.23 to 0.61). Durations of severe neutropenia were also comparable between treatment groups in all subsequent cycles. The rate of febrile neutropenia (temperature ≥ 38.2°C with an ANC < 0.5 x 10⁹/L) across all cycles was lower for patients receiving pegfilgrastim (13%) compared to patients receiving filgrastim (20%) (-7% difference; 95% CI of -19% to +5%). A single SC injection of pegfilgrastim per chemotherapy cycle was safe and well tolerated (see **8 ADVERSE REACTIONS**).

The third study employed a placebo control and evaluated the effect of pegfilgrastim on the incidence of febrile neutropenia when administered in first and all subsequent cycles of a moderately myelosuppressive chemotherapy regimen, docetaxel administered at 100 mg/m² Q3W for 4 cycles, which has been reported to be associated with a febrile neutropenia rate of 10% to 20%.

In this study, 928 patients with metastatic or non-metastatic breast cancer were treated with docetaxel. On day 2 of cycle 1, patients were randomized to receive either a single SC dose of 6 mg of

pegfilgrastim or placebo. Patients who received pegfilgrastim in cycle 1 were scheduled to receive pegfilgrastim in all subsequent cycles. Patients who received placebo in cycle 1 were scheduled to receive placebo in all subsequent cycles; however, patients who experienced febrile neutropenia would receive open-label pegfilgrastim.

The incidence of febrile neutropenia was statistically significantly lower for patients randomized to receive pegfilgrastim versus placebo (1% versus 17%, $p \leq 0.001$). The incidence of hospitalizations and IV anti-infective use associated with a clinical diagnosis of febrile neutropenia was significantly lower in the pegfilgrastim group compared with placebo [1% versus 14%, $p \leq 0.001$; and 2% versus 10%, $p \leq 0.001$, respectively (see Figure 1)].

Figure 1 - Percentage of Subjects With Febrile Neutropenia (FN), Who Were Hospitalized, and Who Received IV Anti-infectives for FN

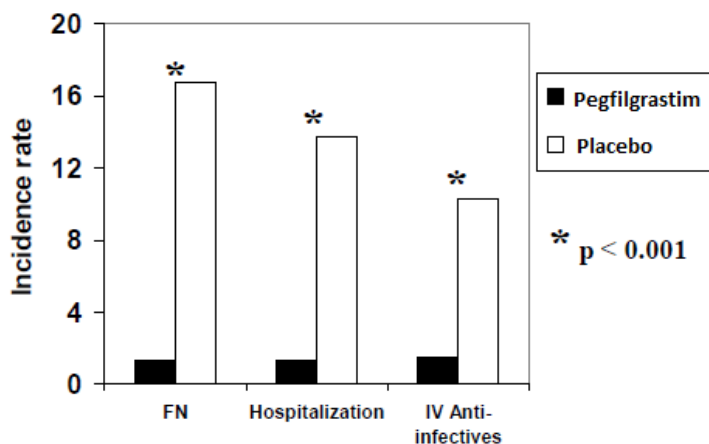

Data from Phase 2 studies in patients with various malignancies undergoing a variety of chemotherapy regimens further support the safety and efficacy of pegfilgrastim. Dose-finding studies in patients with breast cancer ($n = 152$), thoracic tumours ($n = 92$), and non-Hodgkin's lymphoma (NHL) ($n = 49$) demonstrated that the efficacy of a single injection of pegfilgrastim 100 mcg/kg was similar to daily injections of filgrastim 5 mcg/kg/day, and superior to pegfilgrastim doses of 30 or 60 mcg/kg, at reducing the duration of severe neutropenia and the rate of febrile neutropenia. A randomized phase II study of patients with NHL or Hodgkin's lymphoma ($n = 60$) further supports the safety and efficacy of pegfilgrastim.

15 MICROBIOLOGY

No microbiological information is required for this drug product.

16 NON-CLINICAL TOXICOLOGY

Preclinical Studies

The preclinical toxicology of pegfilgrastim was studied in Sprague-Dawley® rats and cynomolgus monkeys. A single-dose IV study was conducted in rats. Pegfilgrastim caused no clinical signs or mortality at single IV doses up to 10,000 mcg/kg in rats.

Repeat-dose studies included 2-week SC (every-other-day dosing) and 6-month SC/IV (weekly dosing) studies in rats and a 1-month SC (weekly dosing) study in monkeys. Dosing was intermittent to mimic intended human use of pegfilgrastim. Pegfilgrastim was well tolerated for 6 months at once-weekly doses up to 1000 mcg/kg SC or 300 mcg/kg IV in rats, and for 1 month at once-weekly doses up to 750 mcg/kg SC in cynomolgus monkeys. No effects on body weight, food consumption, or survival were observed. Pegfilgrastim caused an increase in leukocyte counts, primarily segmented neutrophils, but also some increases in band neutrophils, monocytes, and lymphocytes. Pegfilgrastim also modestly decreased erythrocyte counts, hemoglobin and hematocrit levels, decreased serum cholesterol, slightly decreased serum potassium, and increased serum alkaline phosphatase. Splenomegaly was the principal gross pathological finding. Histopathological examination revealed increased neutrophilic granulopoiesis in bone marrow and extramedullary hematopoiesis in spleen, liver, and/or lymph nodes. Leukocytosis in spleen, liver, and lymph nodes, and mild inflammation and mononuclear cell infiltrate at the injection site were additionally observed in monkeys treated with pegfilgrastim. Observed changes tended to reverse upon cessation of treatment. Changes specific to every-other-day dosing in rats (≥ 500 mcg/kg only) included slightly increased serum ALT and/or AST, mild myelofibrosis in bone marrow, and increased osteoblastic/osteoclastic activity in bone. Little or no seroreactivity to pegfilgrastim was evident in rats, whereas a dose- and time-dependent increase in seroreactivity was observed in monkeys; however, pegfilgrastim-induced neutrophil increases were maintained.

Pegfilgrastim has been shown to have adverse effects in pregnant rabbits when given every-other-day at doses as low as 50 mcg/kg. Nonclinical data in pregnant rats indicate that very low levels of pegfilgrastim may cross the placenta.

Pegfilgrastim administered SC to pregnant rabbits at doses of 200 and 250 mcg/kg every-other-day during the period of organogenesis was associated with an increased incidence of abortions.

Increased postimplantation loss due to early resorptions and decreased numbers of live fetuses were observed at pegfilgrastim doses of 200 to 1000 mcg/kg every other day. Decreased maternal food consumption and/or weight gain and decreased fetal weight were observed at doses of 50 to 1000 mcg/kg every other day. Pegfilgrastim did not cause visceral or skeletal malformations in rabbit fetuses at doses as high as 200 mcg/kg every-other-day and did not cause external malformations in rabbit fetuses at doses as high as 1000 mcg/kg every other day.

Pegfilgrastim was not associated with an increase in external, visceral, or skeletal malformations in fetuses when administered by SC injection to pregnant rats during the period of organogenesis at dose levels up to 1000 mcg/kg every other day. However, an increased incidence of wavy ribs, generally regarded as a reversible pathological finding, was observed in rat fetuses at dose levels of 300 and 1000 mcg/kg every other day. No maternal or neonatal toxicities were observed in female rats administered once-weekly SC injections of pegfilgrastim up to 1000 mcg/kg in a pre- and postnatal developmental study.

Filgrastim is known to be negative in bacterial mutagenesis assays (Ames assay). Pegfilgrastim did not cause precancerous or cancerous lesions in Sprague-Dawley® rats after once-weekly SC injections of up to 1000 mcg/kg for 6 months. Given the similar biochemical activity to filgrastim, the chemical nature of the PEG moiety, and extensive clinical experience with filgrastim, it is considered unlikely that pegfilgrastim would be carcinogenic when used as directed.

Pegfilgrastim is a growth factor that primarily stimulates production of neutrophils and neutrophil precursors; however, the G-CSF receptor through which pegfilgrastim and filgrastim act has been found on tumour cell lines, including some myeloid, T-lymphoid, lung, head and neck, and bladder tumour cell lines. *In vitro* proliferation has been observed in response to filgrastim in some of these cell lines, particularly acute myeloid leukemia (AML) cell lines.

Indices of mating or fertility in male and female Sprague-Dawley® rats were not adversely affected by once-weekly SC injections of pegfilgrastim of up to 1000 mcg/kg for 2 to 4 weeks before and during cohabitation.

17 SUPPORTING PRODUCT MONOGRAPHS

NEULASTA (Pegfilgrastim Injection, Sterile Solution, 6 mg (10 mg/mL)), Submission Control No.:242732, Product Monograph, Amgen Canada Inc. (JAN 08, 2021)

PATIENT MEDICATION INFORMATION

READ THIS FOR SAFE AND EFFECTIVE USE OF YOUR MEDICINE

ZIEXTENZO® (pronounced <zee-ex-ten-zoh>)

pegfilgrastim injection

Read this carefully before you start taking **ZIEXTENZO** and each time you get a refill. This leaflet is a summary and will not tell you everything about this drug. Talk to your healthcare professional about your medical condition and treatment and ask if there is any new information about **ZIEXTENZO**.

ZIEXTENZO is a biosimilar biologic drug (biosimilar) to the reference biologic drug Neulasta. A biosimilar is authorized based on its similarity to a reference biologic drug that was already authorized for sale.

Serious Warnings and Precautions

- Your spleen may become enlarged and can rupture while taking **ZIEXTENZO**. A ruptured spleen can cause death. Call your doctor right away if you have pain in the left upper stomach area or left shoulder tip area.
- If you have sickle cell trait or sickle cell disease, make sure that you tell your doctor before you start taking **ZIEXTENZO** so that the potential risks and benefits can be discussed. In patients with sickle cell trait or sickle cell disease, severe sickle cell crises have been associated with the use of pegfilgrastim. Severe sickle cell crises, in some cases resulting in death, have also been associated with filgrastim, the parent compound of pegfilgrastim.

What is ZIEXTENZO used for?

ZIEXTENZO is used to treat neutropenia (nu-tro-**peen**-ee-ah). Neutropenia is a condition where the body makes too few white blood cells and which may be caused by drugs used to treat cancer. Neutropenia is the most serious common side-effect of chemotherapy. Neutropenia predisposes your body to infections and prevents you from fighting them. Your doctor has decided to prescribe **ZIEXTENZO** for you to increase the number of neutrophils (nu-tro-fils), which will fight infections.

ZIEXTENZO is a man-made, long-acting form of granulocyte colony-stimulating factor (G-CSFF), a substance naturally produced by the body.

How does ZIEXTENZO work?

ZIEXTENZO works by stimulating the bone marrow to make white blood cells. To make sure **ZIEXTENZO** is working, your doctor may ask that you have regular blood tests to count the number of white blood cells. It is important to follow the doctor's instructions about these tests.

What are the ingredients in ZIEXTENZO?

Medicinal ingredient: Pegfilgrastim.

Non-medicinal ingredients: Acetic acid, polysorbate 20, sorbitol, sodium hydroxide and water for injection, USP.

ZIEXTENZO comes in the following dosage forms:

ZIEXTENZO is available in a single-use pre-filled syringe with BD UltraSafe Passive™ Needle Guard, as a clear, colourless to slightly yellowish liquid solution. Each single-use syringe (0.6 mL) of ZIEXTENZO (10 mg/mL) contains 6 mg of pegfilgrastim (based on protein mass only).

Do not use ZIEXTENZO if:

- You are allergic to pegfilgrastim, filgrastim or any of the ingredients of ZIEXTENZO. Check the section above **What are the ingredients in ZIEXTENZO?** and the Product Monograph for a list of ingredients in ZIEXTENZO.
- You are allergic to other medicines made using the bacteria Escherichia coli. Ask your doctor if you are not sure.

To help avoid side effects and ensure proper use, talk to your healthcare professional before you take ZIEXTENZO. Talk about any health conditions or problems you may have, including:

- If you have common signs of infection, such as fever, chills, rash, sore throat, diarrhea, or redness, swelling, or pain around a cut or sore. If you notice any of these symptoms during treatment with ZIEXTENZO, tell your doctor or nurse immediately. ZIEXTENZO can reduce the risk of infection, but it may not prevent all infections. An infection can still happen during the short time when your white blood cell levels are low.
- If there is a lump, swelling, or bruising at the injection site that does not go away, talk to your doctor. Occasionally a problem may develop at the injection site.
- If you have sickle cell trait or sickle cell disease, tell your doctor prior to treatment. If you develop left upper abdominal pain or pain at the tip of your shoulder, tell your doctor or nurse immediately.

Other warnings you should know about:

Your doctor will decide if you are able to give yourself a subcutaneous (i.e. under the skin) injection. ZIEXTENZO should only be injected on the day the doctor has determined for you, and should not be injected until 24 hours after receiving your last dose of chemotherapy in each cycle.

If you are injecting someone else with ZIEXTENZO, it is important that you inform yourself about ZIEXTENZO to know how and when to give the ZIEXTENZO injection.

ZIEXTENZO has not been studied in pregnant women, and its effects on developing babies are not known. It is possible that ZIEXTENZO can get into human breast milk. If you are pregnant, plan to become pregnant, think you may be pregnant, or are breast feeding, you should consult your doctor before using ZIEXTENZO.

More information about ZIEXTENZO is available in the Product Monograph. Any questions should be discussed with your doctor.

Tell your healthcare professional about all the medicines you take, including any drugs, vitamins, minerals, natural supplements or alternative medicines.

The following may interact with ZIEXTENZO:

Drug interactions between ZIEXTENZO and other drugs have not been studied. Drugs such as lithium may affect the release of neutrophils into the blood stream. You should discuss your treatment with your doctor before using ZIEXTENZO.

How to take ZIEXTENZO:

Usual dose:

The recommended dosage of ZIEXTENZO is a single subcutaneous injection, just under the skin, of 6 mg (the contents of one pre-filled syringe), administered once per cycle of chemotherapy. You must wait at least 24 hours after your course of cancer chemotherapy before injecting ZIEXTENZO.

Overdose:

If you think you, or a person you are caring for, have taken too much ZIEXTENZO, contact a healthcare professional, hospital emergency department, or regional poison control centre immediately, even if there are no symptoms.

Missed Dose:

As there should be a two-week period between ZIEXTENZO and your next course of cancer chemotherapy, if you miss a planned dose, consult your doctor before taking the missed dose.

Instructions for Use of the ZIEXTENZO pre-filled syringe with needle guard:

IMPORTANT: TO HELP AVOID A POSSIBLE INFECTION, YOU SHOULD FOLLOW THESE INSTRUCTIONS.

It is important not to try to inject yourself or someone else until you have been trained by your doctor, nurse or pharmacist. Please read all the instructions before injecting. Each sealed blister contains one pre-filled syringe. Each pre-filled syringe contains 6 mg/0.6 mL of ZIEXTENZO drug solution.

ZIEXTENZO pre-filled syringe parts (see Figure A) 6 mg/0.6 mL

Figure A

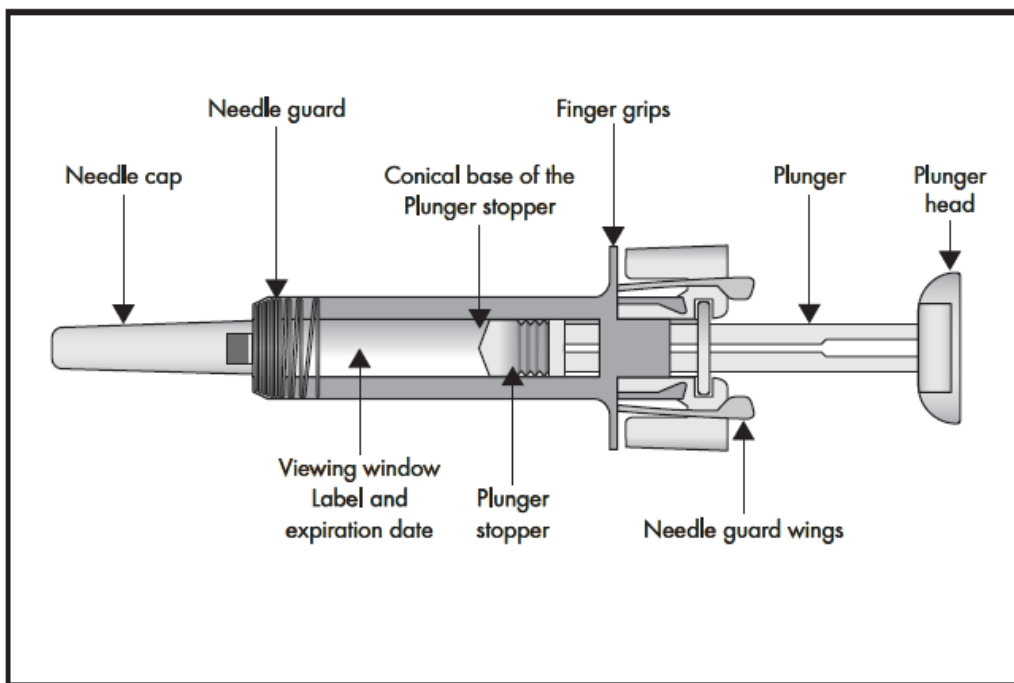

After the medication has been injected the needle guard will be activated to cover the needle. The needle guard is intended to protect healthcare professionals, caregivers, and patients from accidental needle stick injuries after the injection.

Items you additionally need for your injection:

- 1 Alcohol wipe
- 1 Cotton ball or gauze
- Sharps disposal container

Figure B

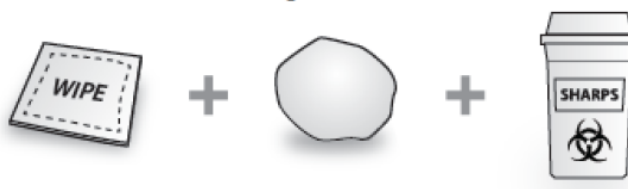

Important safety information

1. Do not open the outer box until you are ready to use the ZIEXTENZO pre-filled syringe.
2. Do not use the ZIEXTENZO pre-filled syringe if the seal of the blister is broken, as it may not be safe for you to use.
3. Do not use the ZIEXTENZO pre-filled syringe if there is liquid in the blister. Do not use the ZIEXTENZO pre-filled syringe if the needle cap is missing or not securely attached. In all these instances, return the entire product pack to the pharmacy.

4. Never leave the ZIEXTENZO pre-filled syringe unattended where others might tamper with it.
5. Do not shake the ZIEXTENZO pre-filled syringe.
6. Be careful not to touch the needle guard wings before use. By touching them, the needle guard may be activated too early.
7. Do not remove the needle cap until just before you give the injection.
8. The ZIEXTENZO pre-filled syringe cannot be re-used. Please dispose the ZIEXTENZO pre-filled syringe immediately after use in a sharps container.
9. Do not use if the syringe has been dropped onto a hard surface or dropped after removing the needle cap.

The Injection Site(s)

Figure C

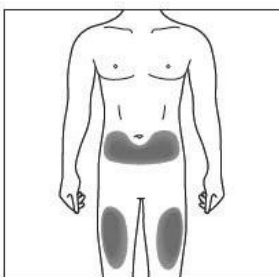

The injection site is the place on the body where you are going to use the ZIEXTENZO pre-filled syringe.

- The recommended site is the front of your thighs. You may also use the lower abdomen, but **not** the area 5 centimetres (2 inches) around the navel (belly button).
- Choose a different site each time you give yourself an injection.
- Do not inject into areas where the skin is tender, bruised, red, scaly or hard. Avoid areas with scars or stretch marks.

Figure D

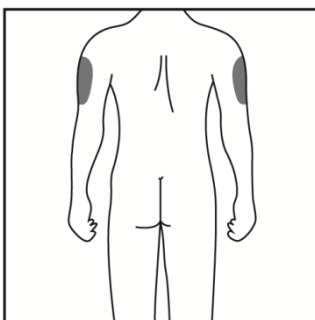

If a caregiver is giving you the injection, the outer upper arms may also be used.

Preparing the ZIEXTENZO pre-filled syringe ready for use

1. Take the blister containing the ZIEXTENZO pre-filled syringe out of the refrigerator and leave it **unopened** for approximately 15-30 minutes, so that it can reach room temperature.
2. When you are ready to use the ZIEXTENZO pre-filled syringe, open the blister and wash your hands thoroughly with soap and water.
3. Clean the injection site with an alcohol wipe.
4. Remove the ZIEXTENZO pre-filled syringe from the blister by holding it in the middle as shown below. Do not grab the plunger. Do not grab the needle cap.

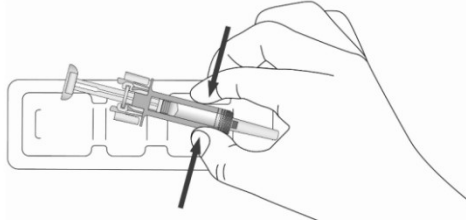

5. Check to ensure the plastic transparent needle guard is situated over the barrel of the glass syringe. If the transparent needle guard is covering the needle cap (as shown below in Figure E) the syringe needle guard has been activated, **DO NOT** use this syringe and take a new syringe. Figure F shows a ready to use syringe.

Figure E DO NOT USE

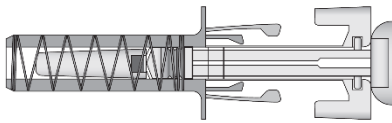

In this configuration the needle guard is **ACTIVATED** – **DO NOT USE** the pre-filled syringe.

Figure F Ready to Use

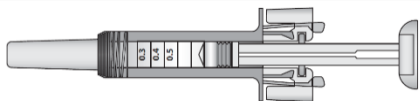

In this configuration the needle guard is **NOT ACTIVATED** and the pre-filled syringe is ready for use.

6. Inspect the ZIEXTENZO pre-filled syringe. The liquid inside should be clear. The color may be colorless to slightly yellowish. You may see a small air bubble in the liquid. This is normal. **DO NOT USE** if any other particulates and/or discolorations are observed and return the pre-filled syringe and the package it came in to the pharmacy.
7. **DO NOT USE** if the ZIEXTENZO pre-filled syringe is broken or activated. In all these instances, return the entire product pack to the pharmacy.

How to use the ZIEXTENZO pre-filled syringe

Figure G

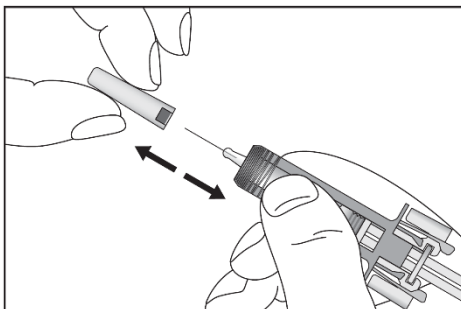

Carefully pull the needle cap straight off to remove it from the ZIEXTENZO pre-filled syringe (**see Figure G**). Discard the needle cap. You may see a drop of liquid at the end of the needle. This is normal.

Figure H

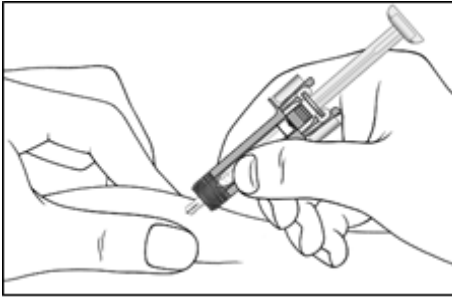

Gently pinch the skin at the injection site and insert the needle into your skin as shown (**see Figure H**). Push the needle all the way in to ensure that the medication can be fully administered.

Figure I

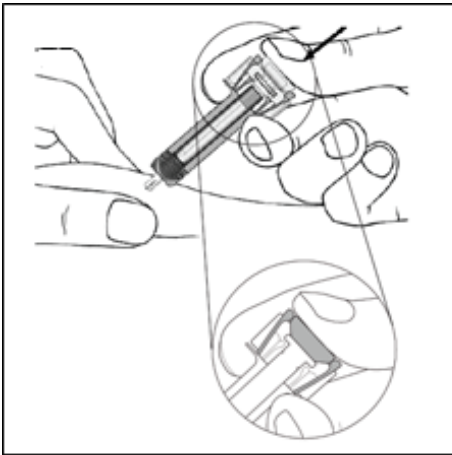

Holding the ZIEXTENZO pre-filled syringe as shown (**see Figure I**), **slowly** depress the plunger **as far as it will go** so that the plunger head is completely between the needle guard wings.

Keep the plunger pressed fully down while you hold the syringe in place for 5 seconds.

Figure J

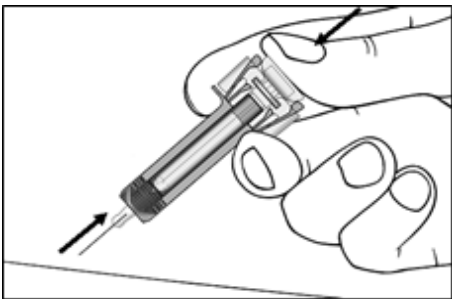

Keep the plunger fully depressed while you carefully pull the needle straight out from the injection site and let it come out of your skin (**see Figure J**).

Figure K

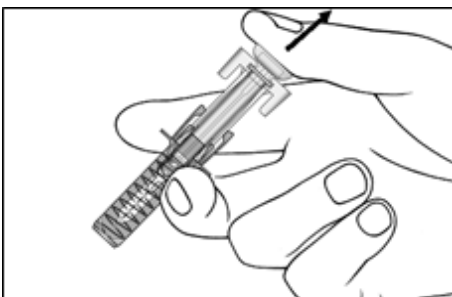

Slowly release the plunger and allow the needle guard to automatically cover the exposed needle (**see Figure K**).

There may be a small amount of blood at the injection site. You can press a cotton ball or gauze onto the injection site and hold it for 10 seconds. Do not rub the injection site. You may cover the injection site with a small adhesive bandage, if needed.

Disposal Instructions

Figure L

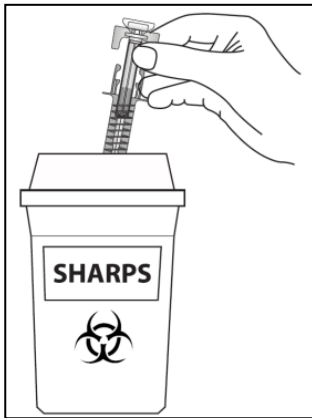

Dispose of the used syringe in a sharps container (closable, puncture-resistant container). For the safety and health of you and others, needles and used syringes **must never** be re-used.

What are possible side effects from using ZIEXTENZO?

These are not all the possible side effects you may have when taking ZIEXTENZO. If you experience any side effects not listed here, tell your healthcare professional. Please also see Serious Warnings and Precautions.

- **Spleen Rupture.** Your spleen may become enlarged and can rupture while taking ZIEXTENZO. A ruptured spleen can cause death. The spleen is located in the upper left section of your stomach area. Call your doctor right away if you have pain in the left upper stomach area or left shoulder tip area. This pain could mean your spleen is enlarged or ruptured.
- **Serious Allergic Reactions.** Serious allergic reactions can also happen. These reactions may cause a rash over the whole body, shortness of breath, wheezing, a drop in blood pressure (usually causing dizziness or lightheadedness), swelling around the mouth or eyes, fast pulse, or sweating. If you experience an allergic reaction during the injection of ZIEXTENZO, the injection should be stopped immediately. **If at any time a serious allergic reaction occurs, immediately call a doctor or emergency services (for example, call 911).**
- **A serious lung problem called acute respiratory distress syndrome (ARDS).** Call your doctor or seek emergency care right away if you or your child has shortness of breath, trouble breathing or a fast rate of breathing.
- **Kidney injury (glomerulonephritis)** has been seen in patients who received ZIEXTENZO. Call your doctor immediately if you experience puffiness in your face or ankles, blood in your urine or brown coloured urine, or if you notice that you urinate less often than usual.

The most common side effect that you may experience is aching in the bones and muscles. If this occurs, it can usually be relieved with a non-acetylsalicylic acid over-the-counter pain reliever. Ask your doctor which is the most suitable one for you.

Some patients experience redness, swelling, or itching at the site of injection. This may be an allergy to the ingredients in ZIEXTENZO, or it may be a local reaction. If you notice any of these signs or symptoms, call your doctor.

| Serious side effects and what to do about them | | | |
|--|--------------------------------------|--------------|---|
| Symptom / effect | Talk to your healthcare professional | | Stop taking drug and get immediate medical help |
| | Only if severe | In all cases | |
| UNCOMMON: $\geq 0.1\%$ and $< 1\%$ | | | |
| Bone Pain. | | ✓ | |
| Low platelet counts (thrombocytopenia) (including the following symptoms: easy bruising and increased bleeding). | | ✓ | |
| Allergic reactions (including the following symptoms: rash over the whole body, shortness of breath, a drop in blood pressure (usually causing dizziness or lightheadedness), swelling around the mouth or eyes, fast pulse, weakness, sweating; severe redness or swelling or itching at injection site). | | ✓ | ✓ |
| Acute respiratory distress syndrome (including the following symptoms: fever, shortness of breath, cough, or congestion in your lungs). | | ✓ | ✓ |
| VERY RARE $< 0.01\%$ | | | |
| Splenomegaly (including the following symptoms: pain in the left upper stomach area or left shoulder tip area). | | ✓ | |
| *FREQUENCY NOT KNOWN | | | |
| Splenic rupture (including the following symptoms: left upper abdominal pain or pain at the tip of your shoulder). | | ✓ | |
| Cutaneous Vasculitis (including the following symptoms: a rash in the skin | | ✓ | |

| Serious side effects and what to do about them | | | |
|--|--------------------------------------|--------------|---|
| Symptom / effect | Talk to your healthcare professional | | Stop taking drug and get immediate medical help |
| | Only if severe | In all cases | |
| surface that looks like purple or red spots or bumps, clusters of small dots, splotches or hives. Your skin may also be itchy). | | | |
| Capillary Leak Syndrome (including the following symptoms: swelling or puffiness, which may be associated with passing water less frequently, difficulty breathing, abdominal swelling and feeling of fullness, and a general feeling of tiredness). | | ✓ | |
| Kidney Injury (glomerulonephritis) (including the following symptoms: puffiness in the face or ankles, blood in urine or brown coloured urine, or urinating less often than usual). | | ✓ | ✓ |
| **Abnormal number of immature bone marrow cells (myelodysplastic syndrome) that could lead to a type of cancer (acute myeloid leukemia) (including the following symptoms: fever, bone pain, bruising, difficulty breathing, bleeding and a general feeling of tiredness). | | ✓ | ✓ |

* Reported in the post-marketing setting where the incidence is not known.

** Adverse events in breast and lung cancer patients receiving chemotherapy and/or radiotherapy

If you have a troublesome symptom or side effect that is not listed here or becomes bad enough to interfere with your daily activities, tell your healthcare professional.

Reporting Side Effects

You can report any suspected side effects associated with the use of health products to Health Canada by:

- Visiting the Web page on Adverse Reaction Reporting (<https://www.canada.ca/en/health-canada/services/drugs-health-products/medeffect-canada.html>) for information on how to report online, by mail or by fax; or
- Calling toll-free at 1-866-234-2345.

NOTE: Contact your health professional if you need information about how to manage your side effects. The Canada Vigilance Program does not provide medical advice.

Storage:

- Store the ZIEXTENZO pre-filled syringe in its outer carton box to protect it from light. Store it in a refrigerator between 2°C and 8°C (36°F and 46°F). DO NOT FREEZE.
- Remember to take the ZIEXTENZO blister out of the refrigerator and let it warm up for 15-30 minutes to allow it to reach room temperature before preparing it for the injection.

Keep ZIEXTENZO out of reach and sight of children.

Do not use ZIEXTENZO pre-filled syringe after the expiration date shown on the outer box and on the pre-filled syringe label. If it has expired, return the entire pack to the pharmacy.

If you want more information about ZIEXTENZO:

- Talk to your healthcare professional
- Find the full product monograph that is prepared for healthcare professionals and includes this Patient Medication Information by visiting the Health Canada website: <https://www.canada.ca/en/health-canada/services/drugs-health-products/drug-products/drug-product-database.html>; the manufacturer's website www.sandoz.ca, or by calling 1-800-361-3062.

This leaflet was prepared by Sandoz Canada Inc.

Last Revised: